

**New Studies Validate  
UBI and  
Ozone**

*Battling  
Disease  
with  
O<sub>3</sub>UV  
Ozone  
Ultraviolet*

*Chronic Heart Failure  
Atherosclerosis  
Traumatic Pain Syndrome  
Pre-surgery Preconditioning  
Peripheral Vascular Disease  
Chronic Fatigue  
Lupus  
Graft Vs Host Disease  
Irritable Bowel  
Scleroderma*

*MS  
Myasthenia Gravis  
Rheumatoid Arthritis  
Allergic Reactions  
Skin Ulcers  
Raynaud's  
Cluster Headaches  
Chronic Lymphocytic Leukemia  
Acute Inflammatory Disorders  
Lyme Disease*

[www.DrsUBI.com](http://www.DrsUBI.com)  
[www.DrsOzone.com](http://www.DrsOzone.com)

## What is available

- 1) A voice over powerpoint that explains the significance for O<sub>3</sub>UV (You tube –Ozone UBI together) or write for a dvd.
- 2) A synopsis of the patents in order 1989 - 2008
- 3) A quick comment on how this area of study might affect future O<sub>3</sub>UV treatment options
- 4) An “Understanding Actions” section - how the disorder works and how O<sub>3</sub>UV helps
- 5) The pdfs of the patents containing all of the studies (over 60)
- 6) Published study abstracts by Vasogen and their physicians

## The Best Medical News for Ozone and UBI (Ultraviolet Blood Irradiation) in the last 40 years

Many have heard of the numerous studies that are available on medical ozone. Three major medical practice documents have been produced from Spain, Russia and Germany. As many as 30,000 physicians use Ozone therapy daily in over 100 countries around the world.

UBI has no less of a medical history starting in 1928. Success followed success as hospitals used this pre-antibiotic, non-drug therapy on hepatitis, sepsis, tuberculosis and a host of other disorders. See [www.infections cured.com](http://www.infections cured.com)

Neither therapy has enjoyed full acceptance in the United States although there are an estimated 500 physicians in the US using either UBI or ozone or both.

New Studies Show that the O<sub>3</sub>UV combination therapy has significant impact on:

- Graft vs Host
- Many forms of Inflammation
- Growth Factor TGF-β<sub>1</sub>
- Vasospastic Disorders
- Endothelin Related Disorders
- Blood Brain Barrier Modulation
- CLL - Chronic Lymphocytic Leukemia
- Blood Platelet Inhibition
- Auto Immune Disorders
- Increasing Nitric Oxide (vasodilation)

- Traumatic Pain Disorder (RSD)
- Preconditioning Stress
- Atherosclerosis
- Chronic Heart Failure

We have compiled these studies and are making them available to you.

A Canadian biotech firm Vasogen, started using ozone and UV light on blood in the 1990s. They also added heat as a stressor but a couple of the studies showed that it was not helpful.

Vasogen was able to raise investor capital in excess of \$ 225 million (this may be a low figure). They accumulated over 24 patents, published numerous studies and left for us an impressive stack of over 60 studies accomplished over the last 15 years. Scores of physicians from prestigious centers such as Sinai Hospital, Cleveland Clinic, Baylor University, St Bartholomew's Hospital, London. Centre hospitalier de l'Université de Montréal, Montreal, Quebec, and over 170 other heart clinics participated in the studies. They validate O3UV as a substantial medical therapy.

Unfortunately for Vasogen investors their Phase III FDA trials failed. They conducted a 2,414 patient study on NYHA Class II thru IV chronic heart failure (CHF) patient. They administered a total of 8 treatments per patient with only 10cc of blood they returned it as an IM gluteal injection. In the end, the study results did not show statistical significance. The stock tumbled from over \$ 16 to less than \$ .25/share. In Class II CHF patients the therapy it reduced deaths and hospitalizations by 39%. This was still not enough to see the company recover.

O3UV may not be perfect for CHF but Vasogen's 60 plus patent studies are invaluable. These studies gave proof to the medical efficacy and action of O3UV. The Ozone and Ultraviolet Light therapy that is commonly used in the US has significant differences from Vasogen's procedure. The similarities allow us to carefully but confidently accept their work as a major piece in understanding and validating O3UV.

We have picked up the informational pieces for anyone who wants to study Vasogen's research. You will find the following in our informational packet and it will eventually be on our websites [www.DrsUBI.com](http://www.DrsUBI.com) and [www.DrsOzone.com](http://www.DrsOzone.com)

This should have tremendous impact on every physician who looks to validate this therapy.

Best to you



Tom Lowe  
Director - Physicians UBI Awareness [www.DrsUBI.com](http://www.DrsUBI.com)  
President – Society of Ozone and Photonic Medicine [www.SopMed.org](http://www.SopMed.org)  
Coordinator - [www.DrsOzone.com](http://www.DrsOzone.com)

[tom@drsubi.com](mailto:tom@drsubi.com)

## Vasogen Patents in order

There are a total of 24 patents that apply to Vasogen and the process of treating a myriad of disorders. The first 2 patents listed are of machines, the rest are on the following categories:

Blood platelets - #3	Graft vs Host # 9
Auto Immune disorders #4	Inflammation # 10,11,12, 19
Nitric Oxide (vasodilation) #5	Growth Factor # 14
Traumatic Pain Disorder (RSD) #6	Vasospastic disorders # 15
Preconditioning stress # 7	Endothelin related disorders # 16
Artherosclerosis and CHF # 8,13	Blood Brain Barrier modulation # 17
	CLL # 18



These patents show an astounding variety of disorders that can be effectively treated with UV light (UBI and Ozone). They also contain over 60 separate clinically controlled studies. Some are double blind placebo studies on humans, many are on human models – mice, rats, rabbits and beagles.

Reading through this science gives undeniable verification of the efficacy and safety for UV light and ozone working together. The following synopsis will assist in getting started.

### P # 1

#### **METHOD FOR THE PHYSIOLOGICALLY & THERAPEUTICALLY EFFECTIVE IRRADIATION OF CORPOREAL VENOUS BLOOD**

May 16, 1989 4,831,268

Fisch – German UBI unit using IV tubing and UVA to blue light wave length not UVC

A method for the radiation of corporeal blood is described with which it is possible to prevent arteriosclerosis related heart and vascular diseases due to disturbances in the fat exchange, or to successfully fight such diseases, without exposing the blood to photosensibilators or without the necessity of additional corporeal activity, or a special diet.

The machine shines light on an IV tube. It is their solution to cleaning non disposable units

The claim to fame is that he introduces the ozone to a blood component and measures the amount of ozone that is not absorbed therefore being able to determine the “therapeutic concentration”. No device is detailed...just boxes stating what it does

## **P # 2**

### **Apparatus for the production of oxygenated blood**

**Nov 6, 1990** US 4968483 A – Muller

This was purchased by Vasogen in 1998 from the German patent holder. It is a basic way to add ozone, UBI and heat in one container with a 3 minute duration of 10cc of blood. They make the parameters wide and allow to catch all those of like devices therefore ensuring they have an enforceable patent.

## **P# 3**

### **1997 METHOD OF INHIBITING THE AGGREGATION OF BLOOD PLATELETS AND STIMULATING THE IMMUNE SYSTEMS OF A HUMAN**

**Jan 7, 1997**, 5,591,457

A method treating peripheral vascular disease; thrombotic diseases, such as coronary thrombosis, pulmonary thrombosis, arterial thrombosis, and venous thrombosis; circulatory disorders, such as Raynaud's disease; stroke; pre-eclampsia; and hypertension.

**Regarding the mechanism:** An increase in EDRF (nitric oxide) levels, therefore, has a double beneficial effect on the circulatory system: it inhibits aggregation of platelets, making the blood more fluid, and it enlarges the diameter of the vessels, improving the flow

...a method of inhibiting blood platelet aggregation in humans, as well as to a method of therapeutically treating human disease conditions associated with blood platelet aggregation. ...a method of stimulating the immune system, and therapeutically treating immune system disorders. This was the initial studies to treatment inhibits platelet aggregation. It also measures prostacyclin, looks at the proliferation of Peripheral Blood Monocytes, stimulation of Activation Markers.

**It finds that O3 and UV need to be used together to have this effect.**

## **P# 4**

### **Treatment of Auto immune diseases –**

**1998** Vasogen 1st WO 98/07436

Nov 9, 1999 US 5980954 A

May 20, 2001 US 6204058 B1

May 27, 2003 US6569467 B1

Vasogen patent to show that stressors cause an auto vaccine against rheumatoid arthritis, scleroderma, MS, Lupus, etc.

HSP 65 discussed – RA – antibodies to HSP 65 –improperly controlled autoimmune response

Trials with 30 RA patients, 4 Raynard, 2 scleroderma and the activation markers were measured

Claim – alleviates autoimmune disease symptoms by one of the following

- a) increased leucocytes showing vacuolation
- b) reduced MHC Class II leucocyte

- c) upregulated expression CD-11b
- d) increased HSP-60 in the plasma
- e) decreased HSP – 70
- f) decreased lymphocyte proliferation
- g) decreased neutrophils to phagocytose

**Example 1** – 30 active RA patients - Blood samples were taken and analyzed for leucocytes, erythrocyte sedimentation rate, rheumatoid factor and C-reactive protein, using standard test procedures. The erythrocyte sedimentation rate and C-reactive protein are elevated in most inflammatory conditions including rheumatoid arthritis.

Erythrocyte sedimentation rate, rheumatoid factor and C-reactive protein all showed significant reduction after the course of treatment. A marked improvement in each case was reported.

**Example 2** – 4 – patients Raynaud – 9 treatments. It reduced an autoimmune response as evidenced by a reduction of auto-antibodies in a treated patient.

**Example 3** – TH1 and TH2 in 13 control normal and 2 scleroderma patients. Results: the TH1:TH2 ratios in these patients was 3.29 and 3.13 respectively, i.e. the ratio had approached the normal range.

**EXAMPLE 4 - Staining of Activation Makers**

The above data for this example are all means of duplicates, and indicate that treatment with UV/ozone according to the invention results in the activation of T-lymphocytes and monocytes.

**P# 5**

**Method of Increasing Nitric Oxide in Human Blood**

Nov 10, 1998 5,834,030 patent

An ozone + UBI study – it uses heat but does not mention it in parts.

For peripheral vascular disease and Heart Failure. Platelet aggregation is one of the factors that leads to cardiovascular disease and increases risk of heart attack and stroke

These nitric oxide associated conditions include: high blood pressure, neurological conditions such as depression, tumors, bacterial and fungal infections, and impotence. It would therefore be desirable to provide a method for increasing the nitric oxide concentration in human blood, in order to treat the above-described human disease states which are characterized by nitric oxide deficiency.

This is one of the better studies for UBI and ozone. 1) **It is safe** – platelets are not damaged and no hemolysis occurs. 2) Better yet – it shows that UV light (at least UVC ) does not inhibit platelets aggregation– 0%, Ozone does a little – 11% and the **2 together are great – 83%**. This is through the nitric oxide mechanism. This was one of the base studies that they did to show that it could help with

TABLE 5

The effect of UV light on platelet aggregation induced by ADP (0.01 mM) in the presence or absence of ozone. (Experiment date 21.01.92, individual M2)		
Percent Inhibition of Platelet Aggregation		
Ozone 35 µg/ml + UV	Ozone 35 µg/ml – UV	No ozone, UV alone
83.4%	11.2%	0%

heart disease. – also peripheral vascular, COPD, etc

This uses patients so it is in vivo studies for the most part. Some blood nitrous oxide and platelet testing also occur in vitro. Excellent to show safety and mechanism of the stressors.

Further, platelet inhibition was found to critically depend on the combined treatment of ultraviolet light and ozone gas, as evidenced in Tables 4 and 5. Treatment with ozone gas alone resulted in minimal inhibition of platelet aggregation, while treatment with ultraviolet light alone produced no inhibition of platelet aggregation.

The treatment of whole blood with ozone/UBI does not destroy the blood platelets. Furthermore, following visual assessment, no marked hemolysis was observed in the treated blood compared with the control blood samples, indicating that the treatment regime had little effect on erythrocyte integrity.

## **P# 6**

### **TREATMENT OF CHRONIC TRAUMATIC PAIN SYNDROMES POST**

**Jul. 11, 2000** 6,086,552 patent

HOU treatment in comparison ... With normal blood of the patient from whom it was extracted, of at least one of the following characterizing features:

- increased numbers of lymphocytes and other leucocytes, exhibiting a condensed apoptotic-like morphology;
- a release of specific proteins from the cell surface of the blood leucocytes, including the MHC Class II molecule HLA-DR, resulting in a reduction in the number of cells expressing such surface proteins;
- an upregulation in the expression of certain cell surface markers for example CD-11b,
- a component of the ligand for the cell adhesion molecule ICAM-1;
- a decrease in the amount of heat shock protein HSP-60 contained in the leucocytes, particularly the lymphocytes, therein, and an increase in HSP-60 in the plasma;
- a decrease in HSP-72 within the lymphocytes; a decrease in proliferation of treated mononuclear cells following mitogenic stimulation.

By inducing an apoptotic-like state in the other leucocytes in the blood comprising the aliquot, as evidenced by the increased numbers of lymphocytes and other leucocytes exhibiting a condensed apoptotic-like morphology therein, these cells may become preferentially by inducing an apoptotic-like state in the lymphocytes and other leucocytes in the blood comprising the aliquot, as evidenced by the increased numbers of lymphocytes and other leucocytes exhibiting a condensed apoptotic-like morphology therein, these cells may become preferentially phagocytosed upon re-injection into the host body.

10ml –Ozone - 120ml/min @ 15ug/ml Heat @ 45 C for 3 minutes UV @ .9-1.8J/cm<sup>2</sup> for 3 minutes

A process of alleviating the symptoms of reflex sympathetic dystrophy in a human patient suffering there from which comprises subjecting the patient to a course of from 18 to 34 treatments as defined in claim 6, over a period of 6—21 weeks.

## **P# 7**

### **TREATMENT OF STRESS AND PRECONDITIONING AGAINST STRESS**

Oct 24, 2000 6,136,308

May 29, 2007 US 7,223,391 B2

#### **Stress – i.e. high blood pressure – any operation with ischemia potential, kidney transplant**

A long study using SHR rats showing .....It is a further object to provide a process of preconditioning a mammalian patient to improve the patient's resistance and reaction to subsequently encountered stress. It is a further and important object of the invention to provide a means of protecting target organs against ischemia/reperfusion injury.

There are 8 examples here. Example 7 - measures **UBI and ozone alone showing** that it is **superior** to the 3 stressor combo

a process of treating a mammalian patient to counteract the adverse effects of stress and/or to precondition the patient for improved resistance and reaction to subsequently encountered stress,

Another preferred use of the present invention is in protecting tissues and organs from stress-induced damage, in a manner similar to ischemic preconditioning.

Basically if someone is going to have surgery or has ischemia or is going to have a transplant. This should be a pretreatment for 5 weeks prior.  
HOU is looked at being applied to pre-surgery for CHF (chronic Heart Failure) patients. Although O3UV did better without heat

## **P# 8**

### **Method for preventing and reversing atherosclerosis in mammals**

Jul 24, 2001 US6264646 B1

Dec 30, 2003 US6669965 B2 – updated and expanded

A method for delaying the onset, retarding the progression, and causing regression of atherosclerosis...

Firstly, there is an observed reduction in total serum cholesterol levels, primarily due to a reduction in the levels of LDL and VLDL cholesterol. Levels of beneficial HDL cholesterol are not reduced

... show substantially reduced deposition of lipids within blood vessel walls, as compared to untreated subjects. As well as retarding the progression of plaque deposition, the treatment of the invention has been shown to cause existing plaques to regress.

**EXAMPLE 1** - The LDL-R deficient mouse model shows intolerance to cholesterol feeding and develops widespread atherosclerotic changes which progress to mature fibrous lesions morphologically indistinguishable from established human atherosclerosis. Apart from the defined genetic abnormality causing predisposition to atherosclerosis

the average triglyceride level of the Treated group is significantly lower than the increase in the average triglyceride level of the HC Diet group,

### **EXAMPLE 2**

Human Studies A – 94 healthy human volunteers – triglycerides lowered

Human Studies B – 49 healthy human volunteers - triglycerides lowered

### **EXAMPLE 3** Animal Studies

The animals of group C (treatment group) also exhibited a marked reduction in xanthelasma and limb swelling as compared to animals of group B. The animals of group C (high cholesterol diet with treatment according to the invention) exhibited profoundly reduced lipid deposition

Conclusions:

The treatment according to the preferred method of the present invention achieved about a forty percent reduction in total serum cholesterol and a significant reduction in triglyceride levels, and substantially inhibited the development of atherosclerosis in a mouse model of human familial hypercholesterolemia.

In addition to substantially reducing the development of atherosclerosis at an early stage and inhibiting the progression of established atherosclerotic lesions, the treatment according to the preferred method of the present invention was shown to cause regression of existing atherosclerotic lesions.

### **P# 9**

**GVHD – Bone Marrow transplant - Extracting allogeneic human donor blood aliquot; separating t-cells; oxidative stressing to reduce cytokines**

Jul 10, 2001 US 6258357 B1

the development of graft versus host disease in a mammalian patient undergoing cell transplantation therapy for treatment of a bone marrow mediated disease, is prevented or alleviated by subjecting at least the T-cells of the allogeneic cell transplantation composition, extracorporeally, to oxidative stress

...a patient being treated by allo-BMT is administered a composition containing T-cells obtained from an allogeneic donor, said T-cells having been subjected in vitro to oxidative stress to induce therein decreased inflammatory cytokine production coupled with reduced proliferative response. It appears that such oxidatively stressed allogeneic T-cells when injected into a mammalian patient, have a down-regulated immune response and a down-regulated destructive allogeneic response against the recipient, so that engraftment of the



hematopoietic stem cells, administered along with or separately from the stressed T-cells, can take effect with significantly reduced risk of development of GVHD.

Another aspect of the present invention provides a population of mammalian T-cells, essentially free of stem cells, said T-cells having been subjected in vitro to oxidative stress so as to induce in said cells an altered cytokine production profile and a reduced proliferative response.

There were 6 example studies - These results indicate that T-cells subjected to oxidative stress alone achieve a decreased proliferative response and decreased inflammatory cytokine production, suitable for use in the present invention.

### **P# 10**

## **INFLAMMATORY CYTOKINE SECRETION INHIBITION**

**Jul. 11, 2002** US 2002/0090360

The present invention relates to a process of decreasing the expression of one or more of the inflammatory cytokines IFN- $\gamma$  and IL-6 by cells in a mammalian patient,

Treating autoimmune diseases, such as rheumatoid arthritis, psoriasis, scleroderma, lupus, diabetes mellitus, organ rejection, miscarriage, multiple sclerosis, inflammatory bowel disease and atherosclerosis; and contact hypersensitivity disorders.

Chronic Fatigue Syndrome: Whilst the etiology of CFS remains contentious, there is a general consensus that IL-6 plays a role in CFS, either as a result of abnormal levels of IL-6 in the patient or abnormal sensitivity to IL-6 on the part of the patient.

**Example 1** was to induce contact hypersensitivity test (CHS). The abdominal skin of each mouse was shaved and painted with dinitrodifluorobenZene (DNFB)... the animals of each group, are particularly noteworthy. The demonstrated reduction in IL-6 shows the potential of the process.

...another therapeutic use of the present invention, namely in association with chemotherapeutic or radiation therapy of malignancies such as lymphomas... to render the patient's malignancy more susceptible to chemotherapeutic or radiation therapy.

### **P# 11**

## **TREATMENT of IL-10 DEFICIENCIES**

**Oct 17, 2002** US 2002/0150560 A1

Mammalian disorders associated with a deficiency in the cytokine interleukin-10 IL-10 can be alleviated. A deficiency of IL-10 results in the development of a number of significant inflammatory events including ischemia-reperfusion injury, and has been implicated in autoimmune diseases such as psoriasis and pemphigus.

The effectiveness of the treatment according to a preferred embodiment of the present invention, on contact hypersensitivity (CHS), was assessed on laboratory rats and mice, (see patent results for more). Four separate EXAMPLE studies were conducted

**P# 12**

**METHODS FOR TREATING THE INFLAMMATORY COMPONENT OF A BRAIN DISORDER**

Oct 24, 2002 US 2002/0155098 A1

Oct 17, 2006 US7122208 B2 – updated

Disclosed are methods for treating and preventing neurological disorders which have a significant inflammatory component. Concentrations of ROS in neuronal cells are reduced.

The following disorders are listed as have a potential cure with the invention: myasthenia gravis, GBS, CIDP, and multiple sclerosis, impairment of long term potentiation (LTP) in the hippocampus. Down's syndrome, Huntington's disease, brain trauma and epilepsy, chronic inflammatory demyelinating polyneuropathy, Guillain-Barré syndrome, myasthenia gravis, dermatomyositis, polymyositis, inclusion body myositis, post stroke, neurosarcoidosis, vascular dementia, closed head trauma, vasospasm, subarachnoid hemorrhage, adrenal leukocytic dystrophy, inclusion body dermatomyositis, minimal cognitive impairment and duchenne muscular dystrophy,

This invention is directed to the surprising and unexpected discovery that such immune modulation therapy can exert beneficial anti-inflammatory effects across the blood- brain barrier of a mammalian patient, apparently through a significant reduction of the accumulation of reactive oxygen species and/or a significant down-regulation of associated inflammatory cytokines such as TNF- $\alpha$  , particularly in the cortical tissue of mammals.

Pg 9 Item 41 – Patient must be analyzed to see if ROS reduction would help.

Frequency – 2 in sequence and 11 day rest before the 3<sup>rd</sup> aliquot  
Possibly one treatment every 30 days for a period of 6 months

Four groups of eight male Wistar rats were used in these experiments.

- FIG. 3 indicates that immune modulation therapy significantly reduces reactive oxygen species accumulation in the cortex.
- The concentration of pro-inflammatory cytokine, TNF- $\alpha$  is significantly reduced in the cortex as a result of immune modulation therapy
- FIG. 5 illustrates that immune modulation therapy decreased JNK activity as indicated by a decrease in the phosphorylated form of JNK.
- FIG. 6 shows that immune modulation therapy reduces the concentration of IL-1 Receptor Type I

This immune modulation therapy reversed the LPS-induced blockage of KCl stimulated glutamate release in untetanized dentate gyrus and to a more significant degree in tetanized tissue

**P# 13**

**TREATMENT OF CONGESTIVE HEART**

May 2, 2002 US 2002/0051766 A1

Aug 2006 US 20060193835 A1 – updated

Nov 3, 2005

US 2005/0244298 A1 – Electrocardiographic Aspects of CHF Treatment

The treatment can be used on its own or as an adjunctive therapy in combination with conventional CHF treatments.

[0105] As demonstrated by the data described above, the treatment of the present invention has been shown to have significant biological activity in humans and in a number of animal model systems, all of which involve Th1/TNF- $\alpha$  dependent inflammatory responses....  
...has been found to improve endothelial function in a number of studies conducted in humans and in animals.

With regard to myocyte loss, the method of the invention is believed to decrease levels of apoptosis and necrosis. It has been shown that the treatment can protect the kidney from ischemia/reperfusion (I/R) damage

6 examples – HOU – All separate studies

1. On endothelial function in Watanabe rabbits, known to develop complex atherosclerotic lesions during the first year of life.
2. 18 human patients with peripheral vascular disease (PVD).
3. adjuvant-induced arthritis in rats – HOU can modulate levels of inflammatory cytokines in a Th1/TNF- $\alpha$ -dependent model of arthritis.
4. Pure-bred normal beagle dogs, effect of reducing apoptosis and necrosis. Renal artery clamped for 60 minutes...ischemia results...
5. 12 male SHR rats - ischemic-reperfusion (I/R) kidneys... cytoprotective effect of the administration of stressed blood according to the invention on renal reperfusion injury involves the inhibition of early or late apoptosis.
6. human patients with advanced chronic congestive heart failure. The patients had NYHA class III-IV

**P# 14**

## **Transforming Growth Factor Regulation**

July 11, 2002 US 2002/0090359 A1

### **Skin Ulcers**

The present invention relates to a process of increasing the LLB expression of TGF- $\beta_1$  by cells in a mammalian patient, comprising administering to the patient an effective amount of stressed mammalian blood cells, said stressed cells having been extracorporeally subjected to at least one stressor selected from oxidative stress and ultraviolet radiation. The process of the present invention **shows potential in the treatment of** ulcers in mammalian patients.

... the process is particularly indicated for the healing of skin ulcers, such as decubitus ulcers, diabetic ulcers and the like.

Example 1 - Balb/c mice, The analyses indicated that animals which had received a course of injection of blood subjected to stressors as described had significantly increased concentrations of TGF-B1 in the lymph node.

Example 2 - 20 human patients having moderate to severe psoriasis. (FIG. 2b). This result is indicative of the use of the process of the invention to upregulate TGF-B1 and therefore in treating ulcers of the skin.

## **P# 15**

### **Concurrent heating, radiation, oxidation of blood; separation of leukocytes; administering – Vasospastic disorders**

Feb 24, 2004 - US6696092 B2

Vasoconstriction disorders, Raynaud's Phenomenon and other vasospastic disorders such as migraine, cluster headache and syndrome X

...blood aliquot capable of generating in the patient's blood stream after administration a population of stimulated leukocytes having upregulated expression of CD25 cell surface markers, along with an enhancement of endothelial function in the patient.

The result of injecting the blood subjected to stressors outside the body is the upregulation of specific cell surface markers such as HLA-DR and CD25 on other, non-treated leukocytes in the peripheral blood, circulating in the patient. This is indicative of an enhanced immune system. It appears that the treated leukocytes release cytokines (intercellular messenger peptides and proteins), or stimulate leukocytes of the recipient to do so, initiating a cascade phenomenon which affects a number of the quiescent leukocytes in the peripheral blood and causes them to become stimulated. This apparently leads to improved blood flow at sites in the body far removed from the site of injection of the treated leukocytes.

Secondly, the stimulated leukocytes present in the blood circulation, perhaps through the intermediary of the same or similar cytokines and probably after physical contact or binding to the endothelium via cell adhesion molecules, act upon the endothelium, either directly or indirectly, to increase the endothelial vasodilator function probably by increasing the production and/or action of vasodilators such as nitric oxide, prostacyclin and/or by inhibiting the production and/or action of vasoconstrictors, so as to increase blood flow.

Example 1 – Raynaud's patient 10 treatments over 2 weeks - symptoms gone

Example 2 – 4 Raynaud's patients - every patient reported a very significant alleviation (see study)

Example 3 – patients above tested blood flow improvements – by iontophoretic technique using

acetylcholine (figure 2)

Example 4 – statistical analysis of # 3

Example 5 – 19 healthy 20-30 yr olds – Double blind study measuring of effects of treatment on platelet

function. Charts 1-10 tell the story.

...the post-treatment 6-keto-PGF $\alpha$  concentrations were significantly ( $p < 0.05$ ) higher on two of the five post-treatment measurement occasions, post-1 and post-4, when compared with the

pre-treatment baseline values. No such significant differences were observed in the placebo-treated control group.  
See study for other results.

## **P# 16**

### **TREATMENT OF ENDOTHELIN-RELATED DISORDERS**

**Dec 16, 2004** US 2004/0253213 A1

Primary pulmonary hypertension (PPH), glaucoma, progression of atherosclerosis.

Endothelin-related disorders in mammals can be alleviated by administration to such patients of one or more aliquots of mammalian blood subjected to two or more stressors selected from temperature stressors, electromagnetic emissions and oxidative environments.

(testing on mice) demonstrating that the treatment of the invention significantly reduced the extent of aortic atherosclerosis. See charts

## **P# 17**

### **BLOOD BRAIN BARRIER MODULATION USING STRESSED AUTOLOGOUS BLOOD CELLS**

**May 27, 2004** US 2004/0101517 A1

**for Alzheimer's, Parkinson's, Dementia**

**Example 1** Four patients, human females ranging in age from 15 to 84 years, and all suffering from an endothelium deficiency-related condition (primary Raynaud's phenomenon)

A significant increase in blood flow in response to acetylcholine, indicative of an enhanced endothelial function, after the course of treatment, is evident from these curves. All four of the patients treated showed essentially similar results, those presented on FIG. 1

**Example 2** – Wistar rats - The stressed cell therapy lowered LPS induced inflammation in the brain and gave improvement in blood brain barrier function even in normal animals, and thus this beneficial effect has the ability to cross the blood brain barrier. Lowered LPS induced inflammation and improvement in the blood brain barrier function present an attractive explanation of the observed beneficial effects of the stressed cell therapy on the endothelium.

**Example 3** Watanabe rabbits in FIG. 4. The reaction of the endothelium-intact sample from the treated animals is significantly different from that of the sham treated animals.

The therapy alone and in combination with other available treatments known to have similar beneficial effects on the endothelium, such as use of the pharmaceuticals as discussed herein, show potential in the treatment of neuro-degenerative disorders such as Alzheimer's Disease, Parkinson's Disease, and senile dementia.

**P# 18**

**Chronic lymphocytic leukemia treatment**

May 11, 2004 US 6733748 B2

Chronic lymphocytic leukemia (CLL) in a patient is treated by administering to the patient oxidatively stressed CLL cells.

A separator can be used or the whole blood component. They mention mechanical stress (preferred) by a needle during extraction. It may include a pharmaceutically acceptable excipient, such as sterile physiological saline.

**Example 1** - After a course of 6 such treatments, administered over three weeks with a two or three-day interval between each treatment, a favorable response was noted. Instead of a continuing increase in white cell count, the patient exhibited a decrease, from 70 to 61. There was also a 50% decrease in peripheral adenopathy. The treatments were well tolerated and no significant side effects have been reported by the patient.

**EXAMPLE 2** - Following the protocol described in Example 1, the following patients have been treated.

A 55-year old man suffering from CLL and diabetes was treated. The increase in his white cell count was arrested, an effect which has lasted one month since the end of treatment.

A 50-year old man suffering from CLL was treated. His white blood cell count dropped from 30 to 15. This lower level has been maintained for at least one month after the conclusion of treatment.

A 50-year old woman suffering from CLL was treated. She had been treated previously for CLL by chemotherapy using Chlorambucil. Her condition had relapsed and the Chlorambucil was no longer effective. After treatment with the above protocol her white blood cell count was stabilized.

A 60-year old man with CLL and heart problems was treated. His white cell count of 30 was stabilized by the course of treatment.

**P 19**

**ACUTE INFLAMMATORY CONDITION TREATMENT**

June 12, 2008 US 2008/0138432 A1

More specific examples of such disorders include allergic contact dermatitis, acute hypersensitivity and respiratory allergy.

This invention provides a method for prophylaxis or treatment of an acute inflammatory disorder, comprising administering to a patient an aliquot of the patient's blood extracted from the patient and treated ex vivo With at least two stressors selected from the group consisting of an oxidizing agent, an electromagnetic emission and elevated temperature.

Irritable contact dermatitis (ICD), or acute dermatitis, is an example of acute inflammation , in a model of which an irritant (2,4-dinitrofluorobenZene (DNFB)) is painted on the shaved skin of a mouse and then after certain time points, the draining lymph nodes are collected and analyzed for the mRNA expression of pro- and anti-inflammatory cytokines. This constitutes an accepted animal model of acute inflammatory disorder.

From the studies the following three applications were stated:

- indication of the potential of the process of the present invention to combat acute IL1- $\beta$  related disorders in mammalian patients, such as early pulmonary inflammation resulting from hepatic injury, unstable angina, acute juvenile and rheumatoid arthritis, and acute ischemia.
- the potential of this invention in treating acute inflammatory disorders, especially those in which IFN- $\gamma$  plays a significant role, such as coronary arterial inflammation, pericarditis and acute coronary syndrome.
- combating IL-12 related acute inflammatory disorders such as acute respiratory syndrome, acute inflammatory response due to organ transplant and acute inflammatory bowel disease.

## Insights for the combined therapy of O<sub>3</sub>UV?

Studies start with the oldest and proceed to the newest. Not all studies are listed.

### P 3

#### 1997 METHOD OF INHIBITING THE AGGREGATION OF BLOOD PLATELETS AND STIMULATING THE IMMUNE SYSTEMS OF A HUMAN

Jan 7, 1997, 5,591,457

### P5

#### Method of Increasing Nitric Oxide in Human Blood

Nov 10, 1998 5,834,030

Platelet aggregation associated conditions include: **peripheral vascular disease; thrombotic diseases such as coronary thrombosis and pulmonary thrombosis; stroke; eclampsia and pre-eclampsia; and hypertension.**

Specifically it worked with Raynaud's Disease  
Most interesting is the action of ozone and UV light.

With the goal of decreased platelet aggregation it showed that  
ozone and UBI together are better.

With regard to peripheral vascular disease, the disease could theoretically be explained by a reduction of endothelial-derived relaxing factor (EDRF), low levels of which lead to a contraction of the smooth muscle of blood vessels, and hence a reduction in the diameter of the lumen of the vessel and a reduction in blood flow. The major naturally occurring EDRF is nitric oxide. In addition, nitric oxide stabilizes blood platelets, reducing their aggregation. An increase in EDRF (nitric oxide) levels, therefore, has a **double beneficial** effect on the circulatory system: it inhibits aggregation of platelets, making the blood more fluid, and it enlarges the diameter of the vessels, improving the flow.

**The method of the invention increases blood levels of nitric oxide**, which may partly explain the effect of inhibiting platelet aggregation achieved by the invention. Additionally, treatment of blood with ultraviolet radiation and ozone gas according to the invention has been found to increase blood levels of prostacyclin, a substance which is known to inhibit platelet aggregation and relax peripheral blood vessels.

#### Ozone concentrations can be too low to be effective

Fig 2 below shows that ozone concentration of 5 µg/ml. is not as effective as 25 µg/ml and also that 25 µg/ml and 50 µg/ml are identical in effect. That is good information to have. Basically that more ozone is not any more effective but a certain level is need to be effective

2:

Concentration of ozone (µg/ml)	5	25	50
Platelet aggregation (%) (mean +/- sd, n = 4)	38.5 +/- 30.9	56.5 +/- 29.4	55.9 +/- 26.4



Table 5 is highly significant in that it shows that Ozone and UV light together makes a big difference in the effect of the therapy.

This shows the synergy of the two together

“Further, platelet inhibition was found to critically depend on the combined treatment of ultraviolet light and ozone gas.”

TABLE 5

The effect of UV light on platelet aggregation induced by ADP (0.01 mM) in the presence or absence of ozone. (Experiment date 21.01.92, individual M2)		
Percent inhibition of platelet aggregation		
Ozone 35 µg/ml + UV	Ozone 35 µg/ml – UV	No ozone, UV alone
83.4%	11.2%	0%

“The above data indicate that treatment with UV/ozone according to the invention results in the stimulation of T-lymphocytes and monocytes, The treatment of blood with ozone gas and ultraviolet light according to the invention is actually inducing an inhibition of platelet aggregation for the following reasons:

1. The inhibitory effect is at least partially dependent on the concentration of ADP, ozone being more inhibitory at lower ADP concentrations. This may be interpreted as the higher agonist concentrations partially overcoming the inhibitory effect of ozone by "hyperstimulating" the platelets. This suggests that the inhibition is at least partially reversible, and is probably not acting by destroying the platelet's ability to aggregate.
2. The inhibitory effect appears to be dose related to ozone concentration, with higher concentrations of ozone resulting in a greater inhibition of platelet aggregation.
3. The inhibitory effect is UV-dependent, suggesting that this is not a non-specific toxic effect caused by the oxidative capacity of the ozone gas.”

Treatment of their blood with UV/ozone resulted in an **increase in the concentration of the prostacyclin metabolite**, suggesting that this may be an additional mechanism whereby the treatment of the invention works to treat peripheral vascular disease and other diseases associated with blood platelet aggregation.

Example 4 - Peripheral Blood Mononuclear Cells – illustrates the immune stimulatory effect on blood. In conclusion treatment with UV/ozone increased the proliferation of peripheral blood mononuclear cells after stimulation by Interleukin-2. Thus, the treatment has an immune-stimulatory effect on blood.

Example 5 – Activation Markers - treatment with UV/ozone results in the stimulation of T-lymphocytes and monocytes, further supporting the data in Example 4 above.

**P 4**

**Treatment of Auto immune diseases**

1998 Vasogen 1st WO 98/07436

Nov 9, 1999 US 5980954 A

May 20, 2001 US 6204058 B1

It shows that stressors (O3UV ) cause an auto vaccine against **rheumatoid arthritis, graft versus host disease, systemic lupus erythematosus (SLE), scleroderma, multiple sclerosis, diabetes, organ rejection, inflammatory bowel disease, psoriasis, and other afflictions.**

Example 1 - 30 active RA patients were improved

Example 2 - Raynaud patients helped

Scleroderma patients testing showed them to reduce TH1 and TH2 in the normal range.

The patients with scleroderma had initial TH1:TH2 ratios of 5.0 and 4.58 respectively. After treatment TH1:TH2 ratios in these patients was 3.29 and 3.13 respectively, i.e. the ratio had approached the normal range.

The combination stressors create an autovaccine that is effective. Heat is also used in this therapy.

## **P 6**

### **Treatment of chronic post-traumatic pain syndromes**

**July 11, 2000** 6,086,552

. A process of alleviating the symptoms of **reflex sympathetic dystrophy - Also known as Complex Regional Pain Syndrome** in a human patient.

Reflex sympathetic dystrophy (RSD) consists of pain and related sensory abnormalities in the motor system and changes in structure of both superficial and deep tissues. Fractures of the bones of the wrists are commonly associated with RSD. Chronic undiagnosed knee pain, with few clinical signs beyond hyperaesthesia and limited movement may suggest RSD. It may only manifest itself days, weeks, or even years after the soft tissue injury has been incurred.

The therapy worked on the single patient that was mentioned. The patient's RSD manifested itself as extremely cold feet, with numerous small wounds (chilblains) on the feet. Even during hot summer weather, the patient experienced problems with foot pains. The patient reported a substantial alleviation, almost complete cure, of her RSD symptoms following the completion of these (2- 9 sessions– 3 per week) courses of treatments. This would be consistent with other actions of the O3UV. Also reports of blue light stimulation has a significant effect on Complex regional pain disorder (CRPD) which is the same issue.

Comment: Trying O3UV on this difficult disorder should occur without hesitation. A study on this would allow this modality to be used. If even partially successful, it would be most welcome.

## **P 7**

### **TREATMENT OF STRESS AND PRECONDITIONING AGAINST STRESS**

**Oct 24, 2000** 6,136,308

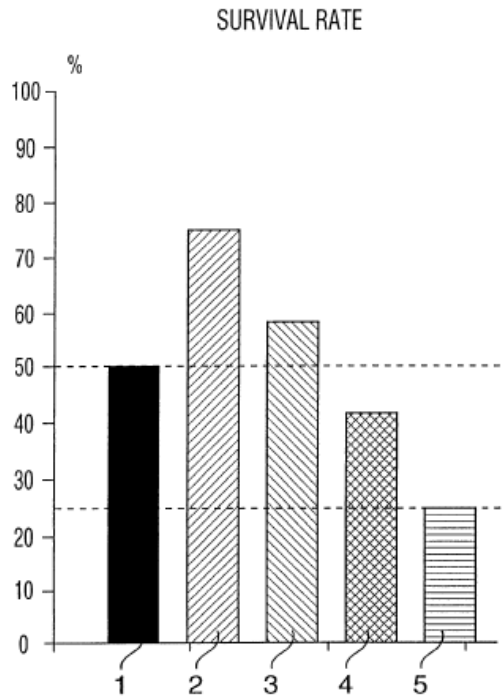
Patients suffering from **unstable angina; a process of treating a mammalian patient to counteract the adverse effects of stress and/or to precondition the patient for improved resistance and reaction to subsequently encountered stress,**

Another preferred use of the present invention is in protecting tissues and organs from stress-induced damage, in a manner similar to ischemic preconditioning.

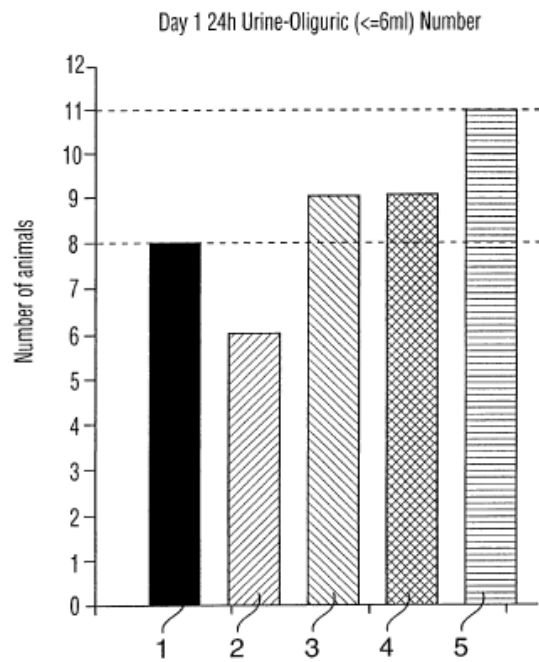
There are 8 examples – **one of particular note showing that O3UV is the therapy of choice**

**Example 7 - SHR male rats**, genetically hypertensive rats 60 in total, were divided into five groups of 12 animals per group

1. bubbling O<sub>2</sub>/O<sub>3</sub> gas mixture being subjected to UV light at elevated temperature of 42.5°C.
- 2. bubbling O<sub>2</sub>/O<sub>3</sub> gas mixture while being subjected to UV light;**
3. bubbling O<sub>2</sub>/O<sub>3</sub> gas mixture with elevated temperature (42.5° C.) by IR lamps;
4. bubbling O<sub>2</sub> gas while maintained at 42.5° C. by IR lamps and being subjected to UV light
5. (placebo) receiving physiological saline in the same quantities and at the same regimen,



**FIG. 13**



**FIG. 14**

The process is thus particularly useful for patients who are scheduled to undergo stress such as surgery at a predetermined future date. They can precondition their bodies to be ready for surgery by undergoing a treatment or a series of treatments according to the invention prior to surgery, with the result that they will withstand the surgery better and will recover from it more quickly, thus reducing the time of hospitalization.

...in protecting tissues and organs from stress-induced damage, in a manner similar to ischemic preconditioning the process of the present invention offers potential for treatment of unstable angina and decrease of infarct size, a treatment not effectively addressed by available therapies.

...the process of the present invention is applicable in the protection of body organs destined for transplantation. ... extends the useful life of the transplant organ between its removal from the donor body and its surgical introduction into the recipient body, thereby reducing losses of viable transplant organs due to transportation delays.

The process of the invention, at the onset ischemic attacks (TIA's, pre-strokes) will precondition the brain to avoid or at least to lessen the severity of the effects of the forthcoming major stroke.

They can be activated through their signal transduction pathways (the SAP kinase pathways or SAP/JN kinase pathway) to affect their phosphorylation function.

In particular, ischemic acute renal failure is an important clinical problem with high morbidity and high mortality. The process of the present invention presents a novel approach to combating this disorder.

Usage: The use of the process of the present invention prior to general anesthesia in connection with major surgery can be viewed as general pre-conditioning of the body, to better withstand ischemia-reperfusion injuries to which the major organs will later be subjected. It is indicated for use prior to conducting major surgical procedures involving general anesthesia in patients known to have or likely to have a significant degree of underlying atherosclerosis in the arteries supplying the brain, heart, liver, intestine, spinal cord, kidneys or limbs, the atherosclerosis rendering them more susceptible to a thrombo-ischemic event in the operative or post-operative period

**P 8**  
**Method for preventing and reversing atherosclerosis in mammals**

Jul 24, 2001 US6264646 B1  
 Dec 30, 2003 US6669965 B2 – updated and expanded

**Chronic Heart Failure, Atherosclerosis, regression of existing atherosclerotic lesions.**

This was why Vasogen were so excited and spent millions on these studies. They do work....it just works better on earlier stage CHF patients.

The treatment according to the preferred method of the present invention achieved about a forty percent reduction in total serum cholesterol and a significant reduction in triglyceride levels, and substantially

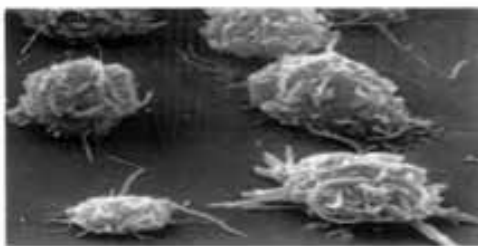
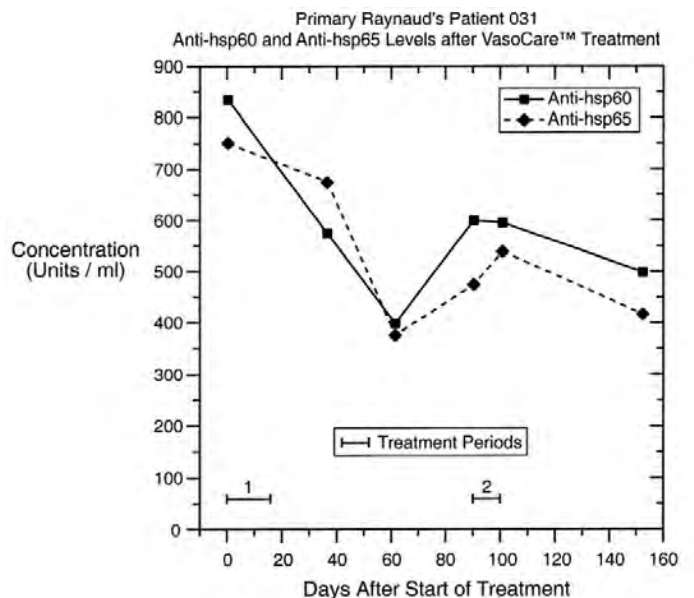


FIG. 1A



FIG. 1B

inhibited the development of atherosclerosis in a mouse model of human familial hypercholesterolemia

In addition to substantially reducing the development of atherosclerosis at an early stage and inhibiting the progression of established atherosclerotic lesions, the treatment according to the preferred method of the present invention was shown to cause regression of existing atherosclerotic lesions. FIG. 1 shows scanning electron micrographs of peripheral blood mononuclear cells isolated from whole blood by density gradient centrifugation, the micrograph labeled (A) showing mononuclear cells obtained from an untreated blood sample, and the micrograph labeled (B) showing mononuclear cells obtained from a sample of blood treated according to the method of the present invention;

## P 9

### GVHD - reducing cytokines; administering to patient undergoing bone marrow transplant

Jul 10, 2001 US 6258357 B1



The development of **graft versus host disease** in a mammalian patient undergoing cell transplantation therapy for treatment of a bone marrow mediated disease, is prevented or alleviated by subjecting at least the T-cells of the allogeneic cell transplantation composition, extracorporeally, to oxidative stress – O3UV

This therapy is a bit more complicated however, the donor T-cells are separated from the other cells, so that only the T-cells are subjected to oxidative stress and then administered to the patient, with the stem cells for engraftment being administered to the patient separately from the treated T-cells.

This would take more study as how O3UV could be used in the intravenous format.

## P 10

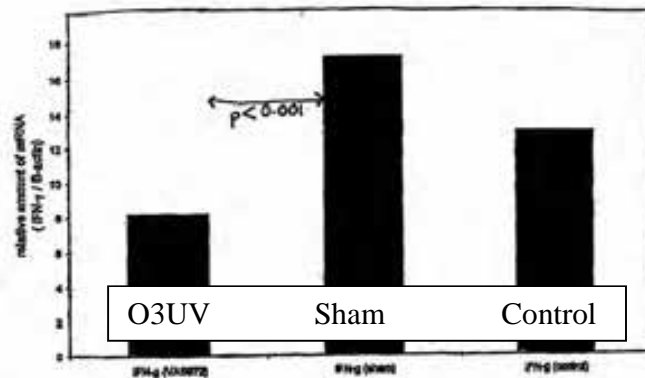
### INFLAMMATORY CYTOKINE SECRETION INHIBITION

Jul. 11, 2002 US 2002/0090360

The present invention relates to a process of decreasing the expression of one or more of the inflammatory cytokines IFN- $\gamma$  and IL-6 by cells in a mammalian patient,

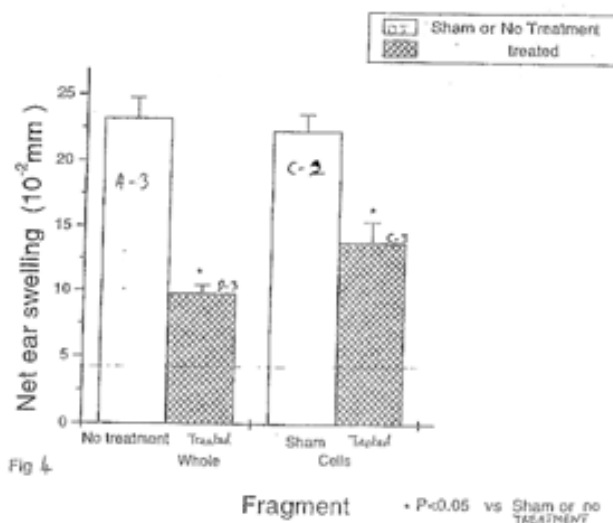
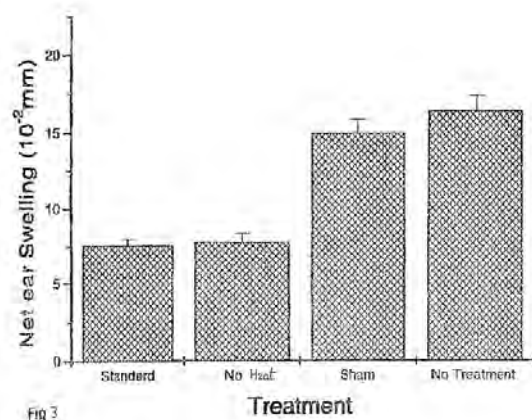
Treating autoimmune diseases such as:

- **rheumatoid arthritis,**
- **psoriasis**
- **scleroderma**
- **lupus**
- **diabetes mellitus**
- **organ rejection**
- **miscarriage**
- **multiple sclerosis**
- **inflammatory bowel disease**
- **atherosclerosis**
- **contact hypersensitivity disorders.**
- **Chronic Fatigue Syndrome:** Whilst the etiology of CFS remains contentious, there is a general consensus that IL-6 plays a role in CFS, either as a result of abnormal levels of IL-6 in the patient or abnormal sensitivity to IL-6 on the part of the patient.



The ability of O3UV to cut inflammation and bring inflammatory cytokines back in control is a tremendous help when dealing with the chronic disorders listed above. We now have another mechanism of action of O3UV. Other interesting results

- 1) Example 3 – shows that D-3 whole blood treated does better than just C-3 the cellular part of the blood
- 2) Below you can see that the addition of heat to O3 and UV actually made no difference or slightly worse than with O3 UV combination alone. This is consistent with other studies that were accomplished.



## P 12

### METHODS FOR TREATING THE INFLAMMATORY COMPONENT OF A BRAIN DISORDERS

Oct 24, 2002 US 2002/0155098 A1

Oct 17, 2006 US7122208 B2 – updated

Disclosed are methods for treating and preventing neurological disorders which have a significant inflammatory component. Concentrations of ROS in neuronal cells are reduced.

...there is a significant down-regulation of associated inflammatory cytokines such as TNF- $\alpha$  particularly in the cortical tissue of mammals.

**Myasthenia gravis, GBS, CIDP, and multiple sclerosis, impairment of long term potentiation (LTP) in the hippocampus. Down's syndrome, Huntington's disease, brain trauma and epilepsy, chronic inflammatory demyelinating polyneuropathy, Guillain-Barré syndrome, dermatomyositis, polymyositis, inclusion body myositis, post stroke, neurosarcoidosis, vascular dementia, closed head trauma, vasospasm, subarachnoid hemorrhage, adrenal leukocytic dystrophy, inclusion body dermatomyositis, minimal cognitive impairment and duchenne muscular dystrophy,**

This invention is directed to the surprising and unexpected discovery that such immune modulation therapy can exert beneficial anti-inflammatory effects across the blood- brain barrier of a mammalian patient, apparently through a significant reduction of the accumulation of reactive oxygen species and/or a significant down-regulation of associated inflammatory cytokines such as TNF- $\alpha$  , particularly in the cortical tissue of mammals.

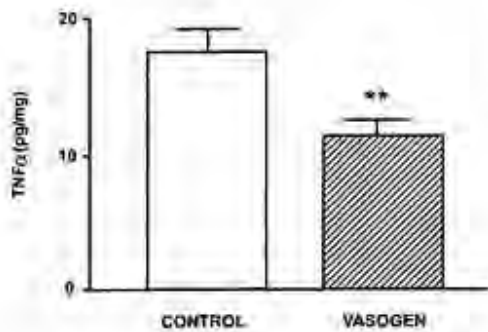


FIG. 4a

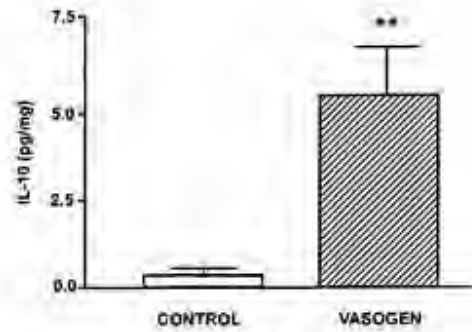


FIG. 4b

FIGS. 4 a and 4 b show that immune modulation therapy significantly reduces TNFα concentration (a) and significantly increases anti-inflammatory cytokine IL-10 concentration (b) in the cortex

## P 13

### TREATMENT OF CONGESTIVE HEART

May 2, 2002

US 2002/0051766 A1

Because the treatment of the invention produces therapeutic benefits in three areas in which pathophysiologic changes occur in CHF, namely

- endothelial dysfunction,
- production of inflammatory cytokines
- myocyte loss due to apoptosis,

there is provided a strong theoretical basis on which to predict that the treatment of the invention would be beneficial to patients with CHF.

Peripheral Vascular Disease (PVD) – 18 patients were also part of the study – moderately advanced 12 treatments.

This is was one of the preliminary studies on CHF. It was successful and other FDA trials were conducted.

## P 14

### Skin ulcers and expression of TGF-β1 Transforming Growth Factor Regulation

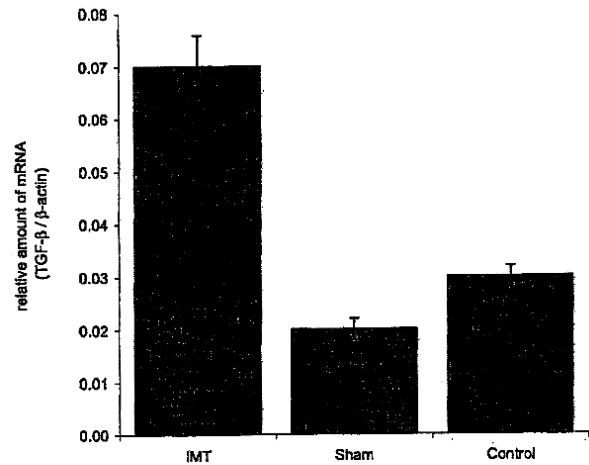
July 11, 2002 US 2002/0090359 A1

The process of the present invention shows potential in the treatment of ulcers in mammalian patients ... the process is particularly indicated for the healing of **skin ulcers, such as decubitus ulcers, diabetic ulcers and the like.**

**Pressure ulcers, bed sores, diabetic ulcers can all benefit from O3UV.** Note the increase in TGF-β<sub>1</sub> from the chart on the right.

Comment: IMT here stands for Immune Modulation Therapy. Also realize from the other studies that show vasodilation, microcirculation improvement and the normal increase in oxygen uptake, along with reduction in inflammatory response. Using this on skin ulcers should help patients.

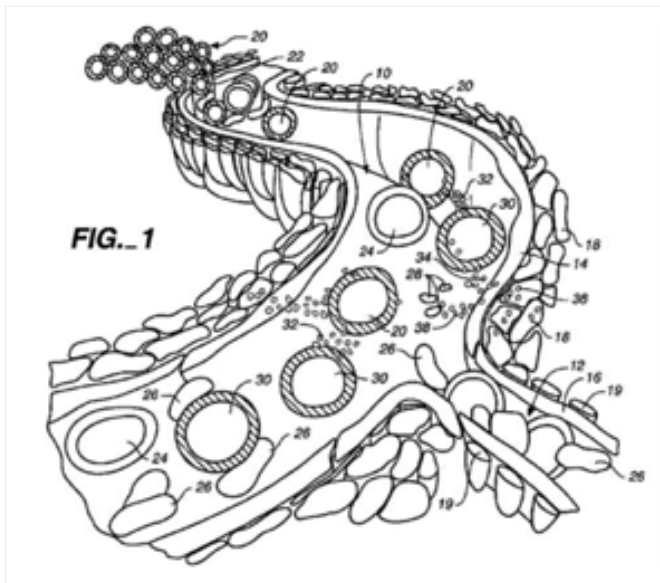
This would be a great application for rest homes and VA hospitals. Wound care facilities may also benefit.



**FIG. 1**

**P 15 Vasospastic disorders**

Feb 24, 2004 - US6696092 B2



**Vasoconstriction disorders, Raynaud's phenomenon and other vasospastic disorders such as migraine, cluster headache and syndrome X**

O3UV stressors cause the upregulation of specific cell surface markers such as HLA-DR and CD25 on other, non-treated leukocytes in the peripheral blood, circulating in the patient. This is indicative of an enhanced immune system. It appears that the treated leukocytes release cytokines (intercellular messenger peptides and proteins), or stimulate leukocytes of the recipient to do so, initiating a cascade phenomenon which affects a number of the quiescent leukocytes in the peripheral blood and causes them to become stimulated. This apparently leads to improved blood flow at sites in the body far removed from the site of injection of the treated leukocytes.

Enhanced Immune System  
Improved Blood Flow



When Raynaud's patients had 10 treatments all symptoms were gone.

An image taken by a thermographic camera. The top hand belongs to a person who suffers from Raynaud's, the bottom hand does not. Red indicates a heat signature whilst green indicates little/no heat.



## P 16

### TREATMENT OF ENDOTHELIN-RELATED DISORDERS

Dec 16, 2004 US 2004/0253213 A1

Although this may deal with glaucoma and also atherosclerosis, it is more of a support to say that it helps in these areas.

Nothing definitive is used from this study at this time

## P 17

### Central nervous system disorders; Alzheimer's disease; Parkinson's disease; –

May 27, 2004 US 2004/0101517 A1

A method of alleviation, prophylaxis against or preconditioning to hinder the on-set and progression of a neurodegenerative disorder, such as **Alzheimer's Disease, Parkinson's Disease or senile dementia**

Since the stressed cell therapy as described herein has a beneficial effect on endothelial function, the therapy alone and in combination with other available treatments known to have similar beneficial effects on the endothelium, such as use of the pharmaceuticals as discussed herein, show potential in the treatment of neurodegenerative disorders such as Alzheimer's Disease, Parkinson's Disease, and senile dementia.

This area is somewhat unknown as to the effect on Blood brain barrier permeability issues. It certainly could be used as a "test" treatment. UBI also has benefits of UBI effects on oxygenation, vasodilation and microcirculation improvement of the blood.

## P 18

### Chronic lymphocytic leukemia treatment

May 11, 2004 US 6733748 B2

Therapy relates to compositions and processes for alleviating chronic lymphocytic leukemia in mammalian patients. **Chronic lymphocytic leukemia (CLL)** in a patient is treated by administering to the patient oxidatively stressed CLL cells

... it is postulated that appropriately oxidatively stressed blood cells activate the regulatory immune T cells controlling the CD5+B cells in the patient's blood, including the malignant CD5+B cells. The oxidatively stressed cells, on reintroduction into the CLL patient, are believed to activate certain T cells present in the patient's blood which then down-regulate the malignant CD5+B cells by acting directly on them or by secreting cytokines which then act on them. In any event, the result is a significant reduction in the rate of proliferation of the malignant CD5+B cells in the CLL patient and a consequent alleviation of the CLL condition and its symptoms.

Although this is a small sampling it shows effectiveness

- A 55-year old man suffering from CLL and diabetes was treated. The increase in his white cell count was arrested, an effect which has lasted one month since the end of treatment.
- A 50-year old man suffering from CLL was treated. His white blood cell count dropped from 30 to 15. This lower level has been maintained for at least one month after the conclusion of treatment.

- A 50-year old woman suffering from CLL was treated. She had been treated previously for CLL by chemotherapy using Chlorambucil. Her condition had relapsed and the Chlorambucil was no longer effective. After treatment with the above protocol her white blood cell count was stabilized.
- A 60-year old man with CLL and heart problems was treated. His white cell count of 30 was stabilized by the course of treatment.

Other studies on CLL with UV light are available and also show positive treatment outcomes  
 US patent 6585676 B1 is such a patent done by Clemson University.

## P 19

### ACUTE INFLAMMATORY CONDITION TREATMENT

June 12, 2008 US 2008/0138432 A1

O3UV cuts acute inflammation (and chronic)

Although there are more obvious applications ...such disorders include allergic contact dermatitis, acute hypersensitivity and respiratory allergy.

This studies has ramifications as listed below:

- indication of the potential of the process of the present invention to combat acute IL1- $\beta$  related disorders in mammalian patients, **such as early pulmonary inflammation resulting from hepatic injury, unstable angina, acute juvenile and rheumatoid arthritis, and acute ischemia.**
- the potential of this invention in treating acute inflammatory disorders, especially those in which IFN- $\gamma$  plays a significant role, **such as coronary arterial inflammation, pericarditis and acute coronary syndrome.**
- combating IL-12 related acute inflammatory disorders such as acute respiratory syndrome, **acute inflammatory response**

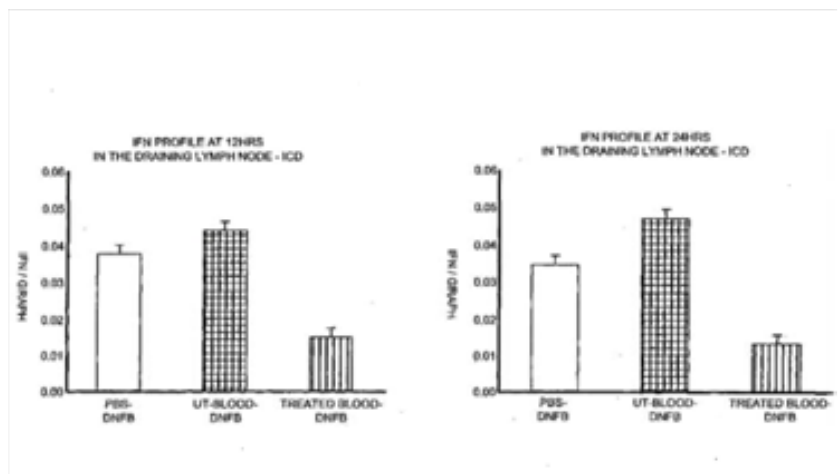


FIG. 2

due to organ transplant and acute inflammatory bowel disease.

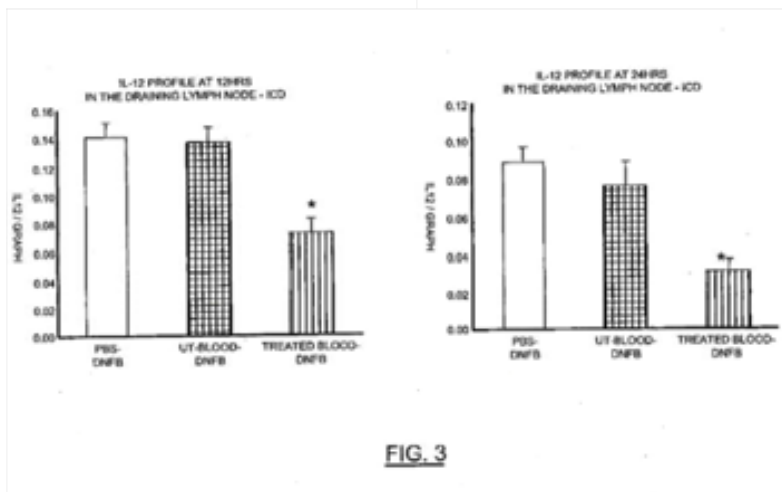


FIG. 3

# Apoptosis and C Reactive Protein

## Treatment of inflammatory disorders with ozone and UV

### AutoImmune Disorders

US 20100316727 A1

#### 1. Field of the Invention

This invention relates to therapeutic treatments for inflammatory disorders and related medical conditions in mammals, and specifically relates to therapeutic treatment of inflammatory disorders or conditions in a mammalian patient using quantifiable absorbed doses of ozone delivered to a biological fluid by an ozone delivery system.

#### 2. Statement of the Related Art

The references discussed herein are provided solely for the purpose of describing the field relating to the invention. Nothing herein is to be construed as an admission that the inventors are not entitled to antedate a disclosure by virtue of prior invention. Furthermore, citation of any document herein is not an admission that the document is prior art, or considered material to patentability of any claim herein, and any statement regarding the content or date of any document is based on the information available to the applicant at the time of filing and does not constitute an affirmation or admission that the statement is correct.

Apoptosis specifically refers to an energy-dependent, asynchronous, genetically controlled process by which unnecessary or damaged single cells self-destruct when apoptosis genes are activated (Martin, S J 1993; Earnshaw, W C 1995). There are three distinct phases of apoptosis. Initially, the cell shrinks and detaches from neighboring cells. The nucleus is broken down with changes in DNA including strand breakage (karyorhexis) and condensation of nuclear chromatin (pyknosis). In the second phase, nuclear fragments and organelles condense and are ultimately packaged in membrane-bound vesicles, exocytosed and ingested by surrounding cells. In the final phase, membrane integrity is finally lost and permeability to dyes (i.e. trypan blue) occurs. The absence of inflammation differentiates apoptosis from necrosis when phagocytized by macrophages and epithelial cells (Kam, P C A 2000).

In contrast, necrotic cell death is a pathological process caused by overwhelming noxious stimuli (Lennon, S V 1991). Synchronously occurring in multiple cells, it is characterized by cell swelling, or "oncosis," resulting in cytoplasmic and nuclear swelling and an early loss of membrane integrity. Bleb formation (blister-like, fluid filled structures) of the plasma membrane occurs, in

which ultimate rupture may occur causing an influx of neutrophils and macrophages in the surrounding tissue, and leading to generalized inflammation (Majno, G 1995).

Four main groups of stimuli for apoptosis have been reported; ionizing radiation and alkylating anticancer drugs causing DNA damage, receptor mechanism modulation (i.e. glucocorticoids, tumor necrosis factor- $\alpha$ , nerve growth factor or Interleukin-3), enhancers of apoptotic pathways (i.e. phosphatases and kinase inhibitors), and agents that cause direct cell membrane damage and include heat, ultraviolet light and oxidizing agents (i.e. superoxide anions, hydroxyl radicals and hydrogen peroxide) (Kam, P C A 2000).

In addition to the oxidizing agents, many chemical and physical treatments capable of inducing apoptosis are also known to evoke oxidative stress (Buttke, M 1994, Chandra, J 2000). Ionizing and ultraviolet radiation both generate reactive oxygen intermediates (ROI) such as hydrogen peroxide and hydroxyl free radicals. Low doses of hydrogen peroxide (10-100  $\mu$ M) induce apoptosis in a number of cell types directly establishing oxidative stress as a mediator of apoptosis. However, high doses of this oxidant induce necrosis, consistent with the concept that the severity of the insult determines the form of cell death (apoptosis vs. necrosis) that occurs. A free radical is not a prerequisite for inducing apoptosis; doxorubicin, cisplatin and ether-linked lipids are anti-neoplastics that induce apoptosis and oxidative damage.

Alternatively, oxidative stress can be induced by decreasing the ability of a cell to scavenge or quench reactive oxygen intermediates (ROI) (Buttke, M 1994). Drugs (i.e. butathionine sulfoxamine) that reduce intracellular glutathione (GSH) render cells more susceptible to oxidative stress-induced apoptosis. Cell studies report a direct relationship between extracellular catalase levels and sensitivity to hydrogen peroxide-induced apoptosis. Apoptosis induced through tumor necrosis factor- $\alpha$  stimulation has been demonstrated to be associated with an increase in intracellular ROI. However, this apoptosis has been inhibited by the addition of a number of antioxidants, such as thioredoxin, a free radical scavenger, and N-acetylcysteine, an antioxidant and GSH precursor.

There is growing evidence that apoptotic neutrophils have an active role to play in the regulation and resolution of inflammation following phagocytosis by macrophages and dendritic cells. A hallmark of phagocytic removal of necrotic neutrophils by macrophages is an inflammatory response including the release of proinflammatory cytokines (Vignola, A M 1998, Beutler, B 1988, Moss, S T 2000, Fadok V A, 2001). In contrast, apoptotic neutrophil clearance is not accompanied by an inflammatory response. Phagocytosis of these apoptotic cells has been shown to inhibit macrophage production of pro-inflammatory cytokines (GM-CSF, IL- $\beta$ , IL-8, TNF- $\alpha$ , TxB<sub>2</sub>, and LTC<sub>4</sub>) with a concomitant activation of anti-inflammatory cytokine production (TGF- $\beta$ , PGE<sub>2</sub> and PAF)(Fadok, V A. 1988, Cvetanovic, M 2004). This phenomenon of suppression of proinflammatory cytokine production by macrophages has been extended to include phagocytosis of apoptotic lymphocytes (Fadok, V A 2001).

In addition to macrophages, down regulation of pro-inflammatory cytokine release in response to apoptotic cells has also been demonstrated by non-phagocytizing cells including human fibroblasts, smooth muscle, vascular endothelial, neuronal and mammary epithelial cells (Fadok, V A 1988, 2000; McDonald, P P 1999, Cvetanovic M, 2006). Apoptotic neutrophils in contact with activated monocytes elicit an immunosuppressive cytokine response, with enhanced IL-10 and TGF- $\beta$  production and only minimal TNF- $\beta$  and IL-1 $\beta$  cytokine production (Byrne, A 2002). Byrne et al. concluded that the interaction between activated monocytes and apoptotic neutrophils may create a unique response, which changes an activated monocyte from being a promoter of the inflammatory cascade into a cell primed to deactivate itself and other cellular targets.

Techniques to identify and quantify apoptosis, and distinguish this event from necrosis, may include staining with nuclear stains allowing visualization of nuclear chromatin clumping (i.e. Hoeschst 33258 and acridine orange) (Earnshaw, W C 1995). Accurate identification of apoptosis is achieved with methods that specifically target the characteristic DNA cleavages. Agarose gel electrophoresis of extracted DNA fragments yields a characteristic 'ladder' pattern which can be used as a marker for apoptosis (Bortner, C D 1995). A lesser extent of DNA degradation produces hexameric structures called 'rosettes' where necrotic cells leave a nondescript smear (Pritchard, D M 1996). Terminal transferase deoxyuridine nick-end labeling of DNA break points (TUNEL analysis), which labels uridine residues of the nuclear DNA fragments, can also be used to quantify apoptosis (Gavrieli, Y 1992).

Several signature events in the process of apoptosis may also be quantified by flow cytometry. These include dissipation of the mitochondrial membrane potential which is an early apoptotic event, externalization of phosphatidylserine through capture with annexin V, loss of plasma membrane integrity and nuclear chromatin condensation (distinguishing live, apoptotic and necrotic cells), and activation of caspase enzymes (early stage feature of apoptosis)(Technical Bulletin—InVitrogen 2004).

Vascular endothelial cells, including human umbilical vein endothelial cells (HUVECs), are known to release potent vasodilators, including nitric oxide (NO) and prostacyclins. Treatment of HUVECs with ozonated serum, an oxidative stressor, results in a significant and steady increase in NO production. Moreover, during twenty-four (24) hour HUVEC incubation with ozonated serum, inhibition of E-selectin release (a proinflammatory mediator) and no effect on endothelin-1 production (a potent vasoconstrictor) has been reported (Valacchi, G 2000). Valacchi et al. has suggested that reinfusion of ozonated blood into patients, by enhancing release of NO, may induce vasodilation in ischemic areas and reduce hypoxia.

CRP is a product of inflammation the synthesis of which by the liver is stimulated by cytokines in response to an inflammatory stimulus. CRP activates the classic complement pathway and participates in the opsonization of ligands for phagocytosis. Initially suggested as solely a biomarker and powerful predictor of cardiovascular risk, CRP now appears to be a mediator of

atherogenesis. CRP has a direct effect on promoting atherosclerotic processes and endothelial cell activation. CRP potently down regulates endothelial nitric oxide synthase (eNOS) transcription and destabilizes eNOS mRNA, which decreases both basal and stimulated nitric oxide (NO) release.

In a synchronous fashion, CRP has been shown to stimulate endothelin-1 (potent vasoconstrictor) and interleukin-6 release (proinflammatory cytokine), upregulate adhesion molecules, and stimulate monocyte chemoattractant protein-1 while facilitating macrophage LDL uptake. More recently, CRP has been shown to facilitate endothelial cell apoptosis and inhibit angiogenesis, as well as potentially upregulate nuclear factor kappa-B, a key nuclear factor that facilitates the transcription of numerous pro-atherosclerotic genes. The direct pro-atherogenic effects of CRP extend beyond the endothelium to the vascular smooth muscle, where it directly upregulates angiotensin type 1 receptors and stimulates vascular smooth muscle migration, proliferation, neointimal formation and reactive oxygen species production.

CRP has several deleterious effects (e.g. reduced survival, differentiation, function, apoptosis, and endothelial progenitor cell-eNOS mRNA expression) on endothelial progenitor cells which are important in neovascularization including induction of blood flow recovery in ischemic limbs and increase in myocardial viability after infarction.

## **Treatment of autoimmune diseases**

**US 6204058 B1**

### **BACKGROUND OF THE INVENTION**

Autoimmune diseases include rheumatoid arthritis, graft versus host disease, systemic lupus erythematosus (SLE), scleroderma, multiple sclerosis, diabetes, organ rejection, inflammatory bowel disease, psoriasis, and other afflictions. It is becoming increasingly apparent that many vascular disorders, including atherosclerotic forms of such disorders, have an autoimmune component, and a number of patients with vascular disease have circulating auto antibodies. Autoimmune diseases may be divided into two general types, namely connective tissue autoimmune diseases (exemplified by arthritis, lupus and scleroderma), and failures of specific organs (exemplified by multiple sclerosis, diabetes and atherosclerosis, in which latter case the vasculature is regarded as a specific organ).

In general terms, a normally functioning immune system distinguishes between the antigens of foreign invading organisms (non-self) and tissues native to its own body (self), so as to provide a defense against foreign organisms. Central to the proper functioning of the immune system, therefore, is the ability of the system to discriminate between self and non-self. When a patient's immune system fails to discriminate between self and non-self and starts to react against self antigens, then an autoimmune disorder arises.

The causes responsible for the reaction of an affected person's immune system against self are not fully understood, and several different theories have been put forward. The immune response to an antigen is triggered by the interaction of the antigen with receptors of predetermined specificity on certain lymphocytes. It is believed that, at an early stage in development of the immune system, those lymphocytes with receptors recognizing self antigens are recognized and eliminated from the body's system by a process of deletion. Alternatively, or in addition, such self-reactive lymphocytes may be controlled by the suppression of their activities. Both mechanisms probably occur.

The immune system of normal healthy individuals is able to identify and to react against a family of proteins which are highly conserved in nature (i.e. they have a similar structure throughout all living organisms). This family of proteins is called the stress or heat-shock proteins (HSP), and they are grouped according to their approximate molecular weights. Members of the HSP family include the HSP60 group, including, among others, proteins in the molecular weight range 50 to 100 kilodaltons. Increased production of HSP's was first identified as a response to heat stress, but this now appears to be part of a general response to a variety of cell stresses. HSPs are normally located within cells, and their function appears to be the stabilization of the structure of

various proteins in stressed cells, so as to protect the cell from the protein denaturing effects of various stressors. However, it is likely that HSPs have a number of other functions which are, as yet, not fully understood. Heat shock proteins, HSP's, are discussed in some detail by William J. Welch, in an article in "Scientific American", May, 1993, page 56.

One group of the family of HSP's, the HSP 60 group, contains proteins which show about 50% identity between bacterial cells and human cells. Infection with bacteria containing HSP 65 results in an immune response in healthy humans against the bacterial HSP65, evidenced by the production of anti-HSP65 antibodies. Thus, a healthy immune system appears to be able to identify and react against self-like antigens.

In certain pathologies, for example many autoimmune diseases such as rheumatoid arthritis and scleroderma, patients also show the presence of antibodies to HSP 65. In the past, this has led to conclusions that autoimmune diseases result from bacterial infection. Now it seems likely that autoimmune diseases can, at least in some cases, be associated with an inappropriate control of the autoimmune response. In other words, it is possible that the antibodies to HSP 65 result from an autoimmune reaction initiated by HSPs from the body itself, but one which has been improperly controlled. In such cases, therefore, it should be possible to control an inappropriate autoimmune response, by stimulating the body's natural immune control mechanisms, using a particular and specific method of vaccination.

To stimulate the body's immune response, a vaccine is required which will, upon injection into the host body, enable the host immune system to present the antigens contained in the vaccine to cells of the host immune system. Antigen presentation is performed by antigen presenting cells.

A vaccine to treat autoimmune diseases should contain antigens or fragments thereof (peptides) that will activate the body's immune control mechanisms present. In addition, the antigens (peptides) should be present in a form which can be recognized by the host immune system when the vaccine is introduced into the host. Certain of the antigens may be present on intact cells. The objective of such a vaccination is to activate regulatory immune pathways, particularly those controlling autoimmune responses, thereby downregulating the autoimmune response.

The particular antigens which will activate the control mechanisms of a mammalian autoimmune system are not fully understood. It is however recognized that they may include antigens derived from lymphocyte receptors, which may function to stimulate control mechanisms, to inhibit those lymphocytes which cause pathological autoimmune responses in the patient. They may also include HSPs, such as the HSP 60 group of proteins, and leucocyte surface molecules such as those of the Major Histocompatibility Complex (MHC) including MHC Class II molecules. MHC Class II molecules function physiologically to present peptides to -antigen-presenting cell as part of the immune response.



## SUMMARY OF THE INVENTION

It is an object of the present invention to provide a novel autovaccine useful in the alleviation of symptoms of at least one autoimmune disease.

It is a further object of the present invention to provide a novel process for the preparation of such an autovaccine.

It is a further and more specific object of the present invention to provide a novel treatment for the alleviation of the symptoms of at least one autoimmune disease in a human patient suffering therefrom.

Accordingly, the present invention provides, from a first aspect, an autovaccine for treatment of an autoimmune disease in a mammalian patient, and derived from an aliquot of the autoimmune patient's own blood. The autovaccine is characterized by the presence therein, in comparison with the normal blood of the autoimmune patient, of at least one of the following characterizing features:

increased numbers of lymphocytes and other leucocytes, exhibiting a condensed apoptotic-like morphology;

a release of specific proteins from the cell surface of the blood leucocytes, including the MHC Class II molecule HLA-DR, resulting in a reduction in the number of cells expressing such surface proteins;

an upregulation in the expression of certain cell surface markers for example CD-11b, a component of the ligand for the cell adhesion molecule ICAM-1; T-cell regulatory molecules such as B7.2, and CTLA-4;

a decrease in the amount of heat shock protein HSP-60 contained in the leucocytes, particularly the lymphocytes, therein, and an increase in HSP-60 in the plasma;

a decrease in HSP-72 within the lymphocytes.

By inducing an apoptotic-like state in the lymphocytes and other leucocytes in the blood comprising the autovaccine, as evidenced by the increased numbers of lymphocytes and other leucocytes exhibiting a condensed apoptotic-like morphology therein, these cells may become preferentially phagocytosed upon re-injection into the host body.

There are a number of different phagocytic cell types present in the mammalian body, including various antigen presenting cells and neutrophils. In order to facilitate phagocytosis by antigen presenting cells rather than by other phagocytes, the lymphocytes and other leucocytes present in the autovaccine of the invention are treated so that they may interact preferentially with antigen presenting phagocytic cells. Cells adhere to each other by a number of mechanisms including the expression of cell adhesion molecules. Cell adhesion molecules present on one cell type interact with specific ligands for particular adhesion molecules present on the adhering cell type. The present invention may result in a preferential interaction of cells in the autovaccine to antigen presenting cells in the host body, by upregulation, on the surface of the cells in the autovaccine, of the expression of the ligand for adhesion molecules found on antigen-presenting cells in the host body. Antigen presenting cells express a number of cell adhesion molecules, including ICAM-1, a component of the ligand of which is CD-11b. One way by which the process of the invention may change the preferential phagocytosis of apoptosing cells is by upregulation of CD-11b.

The preparation of the autovaccine according to the present invention comprises extracting from the patient suffering from an autoimmune disease an aliquot of blood of volume about 0.01 ml to about 400 ml, and contacting the aliquot of blood, extracorporeally, with an immune system-stimulating effective amount of ozone gas and ultraviolet radiation

It is important that the lymphocyte receptors and other cell-derived molecules for vaccination of an auto-immune suffering patient be derived from cells obtained from the same patient, since this system will contain the autoimmune specificity. Receptors on other leucocytes in the blood may alternatively or additionally be important in a proposed vaccination process. The use of such a system as the basis of a vaccine may be considered analogous to the use of a particular viral antigen as a vaccine to treat and prevent disease caused by that virus. A vaccine for treating an autoimmune disease should, therefore, be prepared from a sample of the patient's own blood. Such a vaccine may be described as an autovaccine.

For antigens to be effective in stimulating (or inhibiting) the immune system, the antigens should be presented to immune cells of the host system by antigen-presenting cells, which are naturally present in the body. Many of the antigen-presenting cells are phagocytes, which attach to the antigens, engulf them by phagocytosis, and break them down or process them. The preparation of such an autovaccine should include a process whereby the lymphocytes and other leucocytes in the vaccine, which may be a source of antigens, are in a form whereby they are likely to be phagocytosed by phagocytic antigen-presenting cells upon reinjection into the patient, so that the antigens or effective residues thereof are presented on the surface of an antigen-presenting cell. Then they can effect a controlling mechanism on the immune system, either inhibitory or stimulatory.

During the normal growth period of a mammalian body, tissues become reshaped with areas of cells being removed. This is accomplished by the cells' undergoing a process called programmed cell death or apoptosis, the apoptotic cells disintegrating and being phagocytosed while not becoming disrupted.

## List of Inflammatory Diseases, Disorders and Conditions – Definitions

**Autoimmune/Alloimmune Diseases:** Autoimmune diseases are generally believed to be caused by the failure of the immune system to discriminate between antigens of foreign invading organisms (non-self) and tissues native to its own body (self). When this failure to discriminate between self and non-self occurs and the immune system reacts against self antigens, an autoimmune disorder may arise. Autoimmune diseases, or diseases having an autoimmune component include rheumatoid arthritis, multiple sclerosis, systemic lupus erythematosus (SLE), scleroderma, diabetes, inflammatory bowel disease, psoriasis, pemphigus, atherosclerosis (wherein the vasculature is regarded as a specific organ) and chronic heart failure.

**Rheumatoid arthritis** is an example of a common human autoimmune disease, affecting about 1% of the population. This disease is characterized by chronic inflammation of the synovial joints which may lead to progressive destruction of cartilage and bone.

**Pemphigus** is a group of autoimmune diseases characterized by the formation of watery blisters on the skin. It is an intraepidermal blistering disease characterized clinically by superficial blisters and erosions of the skin and/or mucous membranes, especially the mouth. Anti-inflammatory agents such as corticosteroids are frequently used to inhibit the inflammatory process by inhibiting specific cytokine production.

**Systemic lupus erythematosus (SLE)** is an inflammation of the connective tissues and can afflict every organ system. Ninety percent of patients experience joint inflammation similar to rheumatoid arthritis. Treatment includes anti-inflammatory drugs to control arthritic symptoms and topical corticosteroids for skin. Oral steroids, such as prednisone, are used for treatment of systemic symptoms.

**Scleroderma** is a symptom of a group of diseases that involve the abnormal growth of connective tissue, which supports the skin and internal organs. The rheumatic component of scleroderma is characterized by inflammation and/or pain in the muscles, joints, or fibrous tissue.

**Diabetes** has been increasingly recognized as a disease with low-grade systemic inflammation. This mild inflammatory state is closely related to obesity and insulin resistance wherein adipocytes, especially in the obese, secrete a number of pro-inflammatory cytokines.

**Psoriasis** is the result of highly reactive early cellular inflammation. Psoriasis simultaneously has a rapidly proliferating epidermis, a vigorous acute inflammatory reaction, an accelerated rate of dermal breakdown and repair, and vascular and fibroblast proliferation.

**Atherosclerosis** involves an ongoing inflammatory response, which has a fundamental role in mediating all stages of the disease from initiation through progression and, ultimately, the thrombotic complications of atherosclerosis. Elevation in markers of inflammation predicts outcomes of patients with acute coronary

syndromes. Low-grade chronic inflammation, as indicated by levels of the inflammatory marker C-reactive protein, prospectively defines risk of atherosclerotic complications.

**Chronic heart failure** is a debilitating condition in which the heart's ability to function as a pump is impaired, most frequently as a result of coronary artery disease or hypertension. Chronic inflammation is recognized as contributing to the development and progression of heart failure. Patients with heart failure experience a continuing decline in their health, resulting in an increased frequency of hospitalization and premature death. It is estimated that there are more than 10 million people with chronic heart failure in North America and Europe. The average five-year survival rate for all patients with heart failure is approximately 50%. In the United States alone, there are approximately 300,000 deaths associated with chronic heart failure each year.

**Inflammatory bowel disease** describes two autoimmune disorders of the small intestine; Crohn's disease and ulcerative colitis. Treatment includes the use of anti-inflammatory drugs, including corticosteroids for acute episodes of these diseases.

**Alloimmune diseases** are referred to herein as disorders such as graft versus host disease and tissue transplant rejection, in which an immune response against or by foreign, transplanted tissue can lead to serious complications or can be fatal. In the treatment of these disorders, it is desired to prevent the body from reacting against non-self antigens. Corticosteroids are frequently used to decrease inflammation by suppressing migration of polymorphonuclear leukocytes and reversing increased capillary permeability.

**Neurological disorders:** Inflammatory cytokines are implicated in inflammation-related disorders of the brain, namely the neuroinflammatory, neurodegenerative and neurological disorders such as Alzheimer's disease, senile dementia, multiple sclerosis, depression, Down's syndrome, Huntington's disease, peripheral neuropathies, spinal cord diseases, neuropathic joint diseases, chronic inflammatory demyelinating disease (CIPD), neuropathies including mononeuropathy, polyneuropathy, symmetrical distal sensory neuropathy, cystic fibrosis, neuromuscular junction disorders, myasthenias and Parkinson's disease.

Certain neurological brain disorders such as Down's syndrome, epilepsy, brain trauma and Huntington's disease (chorea) are currently understood to involve inflammation of brain cells as a significant component of the underlying pathology of the disorder.

Other neurological disorders which have a significant inflammatory component include Guillain-Barré syndrome (GBS), chronic inflammatory demyelinating polyneuropathy (CIDP), myasthenia gravis (MG), dermatomyositis, polymyositis, inclusion body myositis, ischemic stroke, neurosarcoidosis, vascular dementia, vasospasm, subarachnoid hemorrhage, adrenal leukocytic dystrophy (storage disorders), inclusion body dermatomyositis, minimal cognitive impairment and Duchenne muscular dystrophy.

**Chronic inflammatory demyelinating polyneuropathy (CIDP)** is a neurological disorder characterized by slowly progressive weakness and sensory dysfunction of the legs and arms. The disorder, which is

sometimes called chronic relapsing polyneuropathy, is caused by damage to the myelin sheath of the peripheral nerves. Primary symptoms include slowly progressive muscle weakness and sensory dysfunction affecting the upper and lower extremities.

CIDP is closely related to the more common, acute demyelinating neuropathy known as Guillain-Barré syndrome (GBS). CIDP is considered the chronic counterpart of the acute disease GBS. CIDP is distinguished from GBS, chiefly by clinical course and prognosis.

**Guillain-Barré Syndrome (GBS)** is an acute predominately motor polyneuropathy with spontaneous recovery that may lead to severe quadriplegia and requires artificial ventilation in 20-30% of patients. The most common disease that underlies this syndrome has been classified as acute inflammatory demyelinating polyneuropathy (AIDP).

**Autoimmune myasthenia gravis (MG)** is a disorder of neuromuscular transmission leading to fluctuating weakness and abnormal fatigability. Weakness is attributed to the blockade of acetylcholine receptors at the neuromuscular endplate by circulating autoantibodies, followed by local complement activation and destruction of acetylcholine receptors.

The causes of the inflammatory muscle diseases dermatomyositis, polymyositis and inclusion body myositis (IBM) are unknown, but immune mechanisms are strongly implicated. Although clinically and immunopathologically distinct, these diseases share three dominant histological features: inflammation, fibrosis and loss of muscle fibers.

**Sarcoidosis** is a multisystem chronic disorder with unknown cause and a worldwide distribution. Neurosarcoidosis is a complication of sarcoidosis involving inflammation and abnormal deposits in the tissues of the nervous system. Sudden, transient facial palsy is common with involvement of cranial nerve VII. Other manifestations include aseptic meningitis, hydrocephalus, parenchymatous disease of the central nervous system, peripheral neuropathy and myopathy. Intracranial sarcoid may mimic various forms of meningitis, including carcinomatous and intracranial mass lesions such as meningioma, lymphoma and glioma, based on neuroradiological imaging.

**Vascular dementia (VaD)** is the general term for dementia caused by organic lesions of vascular origin, such as cerebral infarction, intracerebral hemorrhage or ischemic changes in subcortical white matter. It is the most frequent cause of dementia after Alzheimer's dementia accounting for about 20% of cases and 50% in subjects over 80 years. An inflammatory component has been indicated in a variety of underlying diseases under the umbrella of VaD.

**Cerebral vasospasm** is delayed onset cerebral artery narrowing in response to blood clots left in the subarachnoid space after spontaneous aneurysmal subarachnoid hemorrhage (SAH). It is angiographically characterized as the persistent luminal narrowing of the major extraparenchymal cerebral arteries and affects the cerebral microcirculation and causes decreased cerebral blood flow (CBF) and delayed ischemic

neurological deficits. Production of pro-inflammatory cytokines in the cerebrospinal fluid following SAH has also been demonstrated.

**Duchenne muscular dystrophy (DMD)** is one of the most common, inherited, lethal disorders in childhood. It is an X-linked neuromuscular disease that affects 1 in 3500 males. Progressive muscle weakness begins between 2 and 5 years of age and ultimately leads to premature death by respiratory or cardiac failure during the middle to late twenties. DMD patients lack the protein dystrophin which is an essential link in the complex of proteins that connect the cytoskeleton to the extracellular matrix. Evidence suggests that these patients exhibit immune cells similar to those found in inflammatory disease such as polymyositis. Current research further indicates that T cells may play a role in the pathology of dystrophin deficiency as well as an autoimmune component.

**Multiple sclerosis**, an autoimmune disease of the central nervous system expresses an inflammatory component that is treated with corticosteroids to reduce inflammation.

**Ischemic stroke** is caused by a blockage in a blood vessel that stops the flow of blood and deprives the surrounding brain tissue of oxygen. Within seconds to minutes of the loss of perfusion to a portion of the brain, an ischemic cascade is initiated. Allowed to progress, it will cause a central area of irreversible infarction surrounded by an area of potentially reversible ischemic penumbra. Metabolic aberrations create an intracellular gradient responsible for intracellular accumulation of water (i.e. cytotoxic edema). This is followed by the formation of pro-inflammatory cytokines and other factors that, in turn, cause further inflammation and microcirculatory compromise resulting in vasogenic edema. In addition, there is evidence indicating that the vascular endothelium plays a major role in the regulation of blood flow and is of importance in connection with cardiovascular disorders including inflammatory diseases. A dysfunctional endothelium may be a contributory factor in the demise of the ischemic penumbra.

**Edema** is a condition characterized by abnormally large fluid volume in the circulatory system or in tissues between the body's cells (interstitial spaces) which can cause mild to severe swelling in one or more parts of the body. Factors that can upset the balance of fluid in the body to cause edema, including: immobility of the lower limbs, medications (steroids, hormone replacements, non-steroidal anti-inflammatory drugs (NSAIDs), intake of salt, menstruation and pregnancy. Medical conditions that may cause edema include: heart failure, kidney disease, thyroid or liver disease, malnutrition, thrombosis, infection, lymphedema and solid tumors. Symptoms vary depending on the cause of edema. In general, weight gain, puffy eyelids, and swelling of the legs may occur as a result of excess fluid volume. Pulse rate and blood pressure may be elevated.

**Edema-related conditions** include traumatic brain injury, which is associated with a variety of physiological and cellular phenomena such as ischemia, increased permeability of the blood-brain barrier, necrosis and motor and memory dysfunction. Ischemia caused by the initial brain injury induces a cascade of secondary events which ultimately lead to cellular death. Experimental models for closed head injury have demonstrated induction of pro-inflammatory cytokine release which in conjunction with damage to endothelial cells results in disruption of the blood brain barrier integrity.

**Spinal cord injury initiates** a cascade of biochemical and cellular events that includes an inflammatory immune system response. Immediately after the injury, a major reduction in blood flow to the site occurs. Cells that line the still-intact blood vessels in the spinal cord begin to swell, which continues to reduce blood flow to the injured area. Influx of fluid and immune cells (neutrophils, T cells, macrophages and monocytes) past the compromised blood brain barriers causes inflammation, which is exacerbated by pro-inflammatory cytokine release by a variety of neuroglial cells and astrocytes furthering damage to the injured spinal cord.

**Soft tissue injury** is an acute connective tissue injury that may involve muscle, ligament, tendon, capsular and cartilaginous structures. In a sprain, strain, bruise or crush, the local network of blood vessels is damaged, and the oxygenated blood can no longer reach the affected tissue, resulting in cellular damage. Increases in temperature, redness, pain and swelling (localized edema) characterize the initial inflammatory phase. Inflammatory swelling starts to develop approximately two hours after the injury and may last for days or weeks. Immediate management includes control of the acute inflammatory response.

A variety of imaging techniques are available to assess the degree of edema surrounding an infarct site and blood flow to the ischemic penumbra in ischemic brain stroke patients. Examples include: Computerized Axial Tomography (CT scan), Doppler sonography, and Magnetic Resonance Imaging

At present, the most common method of assessing endothelium-mediated vasorelaxation is brachial arterial (BA) imaging, which involves taking high resolution ultrasound images to determine the diameter of the BA before and after several minutes of arterial occlusion. The change in arterial diameter is a measure of flow-mediated vasorelaxation (FMVR).

Other methods of vasorelaxation measurement include inducing an artificial pulse at the superficial radial artery via a linear actuator. An ultrasonic Doppler stethoscope detects the pulse 10-20 cm upstream from the initial pulse. The delay between pulse application and detection provides the pulse transit time (PTT). PTT is measured before and after five minutes of BA occlusion and reactive hyperemia. As the blood flow increases after occlusion, the endothelial cells that line the inner wall of the artery sense the increased friction and chemical composition of the blood and release relaxing agents into the artery's smooth muscle. The healthier the vascular system, the better the endothelial layer functions and the greater the difference will be between the pre- and post-occlusion measurements.

**Measures of patient inflammation** may include physical assessment of joint stiffness, elevated temperature and reported pain. Laboratory measures of inflammation may include elevation in leukocyte count including differential, coagulation system measurement, inflammatory cytokine (including IL-6 and IL-8) elevation, and increases in C-reactive protein (including high sensitivity CRP) and procalcitonin levels.



## METHODS FOR TREATING THE INFLAMMATORY COMPONENT OF A BRAIN DISORDER

Oct 24, 2002 US 2002/0155098 A1

Oct 17, 2006 US7122208 B2 – updated

### BACKGROUND OF THE INVENTION

#### 1. Field of the Invention

This invention is directed to methods for treating the inflammatory component of brain disorders in mammalian patients, and more particularly for treating those neurological brain disorders in which reactive oxygen species play a significant role in the underlying inflammatory pathology.

#### 2. State of the Art

The events that lead to neurological disorders with a significant inflammatory component (including myasthenia gravis, GBS, CIDP, and multiple sclerosis) are not clear, but the following sequential steps appear to be critical. (1) The breaking of tolerance, a process in which cytokines, molecular mimicry, or superantigens may play a role in rendering previously anergic T-cells to recognize neural autoantigens. (2) Antigen recognition by the T-cell receptor complex and processing of the antigen via the major histocompatibility complex class I or II. (3) Costimulatory factors, especially B7 and B7-binding proteins (CD28, CTLA-4) and intercellular adhesion molecule (ICAM-1) and its leukocyte function-associated (LFA)-1 ligand. (4) Traffic of the activated T cells across the blood-brain or blood-nerve barrier via a series of adhesion molecules that include selectins, leukocyte integrins (LFA-1, Mac-1, very late activating antigen (VLA)-4) and their counterreceptors (ICAM-1, vascular cell adhesion molecule (VCAM)) on the endothelial cells. (5) Tissue injury when the activated T cells, macrophages, or specific autoantibodies find their antigenic targets on glial cells, myelin, axon, calcium channels, or muscle.

In designing specific immunotherapy, the main components involved in every step of the immune response need to be considered. Targets for specific therapy in neurological disease include agents and treatments that (a) interfere or compete with antigen recognition or stimulation; (b) inhibit costimulatory signals or cytokines; (c) inhibit the traffic of the activated cells to tissues; and (d) intervene at the antigen recognition sites in the targeted organ.

Reactive oxygen species (ROS) are activated forms of oxygen, including superoxide anion ( $O_2^-$ ) and hydroxyl radicals ( $HO\cdot$ ) together with hydrogen peroxide ( $H_2O_2$ ) and various unstable intermediates of lipid peroxidation. They are generated as a result of aerobic metabolism. Neuronal brain tissue is particularly susceptible to oxidative damage due its to high consumption of oxygen and its limited

antioxidant defense system. Reactive oxygen species formation is thought to have an impact on synaptic plasticity, cell signaling and the aging process. An age-related increase in reactive oxygen species production has been demonstrated (Martin et al., 2000) and the accumulation of reactive oxygen species has also been shown to be increased in the hippocampus as a consequence of peripheral LPS administration (Vereker et al., 2000a). This is mimicked by IL-1 $\beta$  administration (Vereker et al., 2000b). O'Donnell and colleagues (2000) have reported parallel changes in reactive oxygen species formation and IL-1 $\beta$  production; reactive oxygen species formation was shown to cause an increase in IL-1 $\beta$  production while IL-1 $\beta$  has the ability to induce reactive oxygen species formation thus suggesting the existence of a positive feedback loop which is potentially damaging to cells.

Increased concentrations of IL-1 $\beta$  have also been closely linked with neuronal degeneration (Mogi et al., 1996; Tenneti et al., 1998).

Enhanced activity of the stress-activated kinase c-Jun NH<sub>2</sub>-terminal kinase (JNK) is associated with cell degeneration and death (Park et al., 1996; Maroney et al., 1998), and has been shown to be activated in the hippocampus by several agents, including hydrogen peroxide, an inducer of reactive oxygen species production, and pro-inflammatory cytokines.

Another example of a neuronal brain deficit induced by IL-1 $\beta$  and LPS, is the impairment of long term potentiation (LTP) in the hippocampus (Vereker et al 2000a; Murray & Lynch, 1998). LTP is a form of synaptic plasticity that was originally described in the hippocampus, a brain region that is particularly vulnerable to degeneration which is associated with cognitive dysfunction. On the basis of this and other observations, LTP has been proposed as a biological substrate for learning and memory (Bliss & Collingridge, 1993).

Certain neurological brain disorders such as Down's syndrome (Layton et al., Kedziora et al., Schuchmann et al.), epilepsy, brain trauma (e.g. physical damage to the brain such as concussion)(Layton et al., Wildburgur et al., Trembovler et al.) and Huntington's disease (chorea)(Green) are currently understood to involve inflammation of brain cells as a significant component of the underlying pathology of the disorder. This inflammation could be the consequence of one or more of a variety of biological processes, such as the generation of excess-amounts of inflammatory cytokines such as IL-1 $\beta$  and TNF- $\alpha$ , in the brain cells or other components of the brain tissue, perhaps associated with the presence of high concentrations of reactive oxygen species in the brain tissue, which correlates to high levels of tissue damage or exacerbation of the disease. Reactive oxygen species are one of the effectors of inflammation in tissue such as brain tissue.

Other neurological disorders which have a significant inflammatory component include Guillain-Barré syndrome (GBS), chronic inflammatory demyelinating polyneuropathy (CIDP), myasthenia gravis (MG), dermatomyositis, polymyositis, inclusion body myositis, post stroke, neurosarcoidosis, vascular dementia, closed head trauma, vasospasm, subarachnoid hemorrhage, adrenal leukocytic dystrophy (storage

disorders), inclusion body dermatomyositis, minimal cognitive impairment and Duchenne muscular dystrophy.

Chronic inflammatory demyelinating polyneuropathy (CIDP) is a neurological disorder characterized by slowly progressive weakness and sensory dysfunction of the legs and arms. The disorder, which is sometimes called chronic relapsing polyneuropathy, is caused by damage to the myelin sheath of the peripheral nerves. CIDP can occur at any age and in both genders, is more common in young adults, and in men more so than women. The primary symptoms include slowly progressive muscle weakness and sensory dysfunction affecting the upper and lower extremities. Other symptoms may include fatigue; abnormal sensations including burning, numbness and/or tingling sensations (beginning in the toes and fingers); paralysis of the arms and/or legs; weakened or absent deep tendon reflexes (areflexia); and, aching pain affecting various muscle groups.

CIDP is closely related to the more common, acute demyelinating neuropathy known as Guillain-Barré syndrome (GBS). CIDP is considered the chronic counterpart of the acute disease GBS. CIDP is distinguished from GBS, chiefly by clinical course and prognosis. However, both disorders have similar clinical features, and both share the CSF albuminocytological dissociation and the pathological abnormalities of multi-focal inflammatory segmental demyelination with associated nerve conduction features reflecting demyelination.

Guillain-Barré Syndrome (GBS) is an acute predominately motor polyneuropathy with spontaneous recovery that may lead to severe quadriplegia and requires artificial ventilation in 20–30% of patients. The diseases that underlie this syndrome have been classified as acute inflammatory demyelinating polyneuropathy (AIDP), the most common form, acute motor and sensory axonal neuropathy (AMSAN), and acute motor axonal neuropathy (AMAN). Fisher syndrome is a cranial nerve variant of GBS which characteristically results in ophthalmoplegia, ataxia and areflexia. GBS is often preceded by infection with either *Campylobacter jejuni*, which is most common, cytomegalovirus (CMV), Epstein-Barr virus or *Mycoplasma pneumoniae*.

Autoimmune myasthenia gravis (MG) is a disorder of neuromuscular transmission leading to fluctuating weakness and abnormal fatigability. Weakness is attributed to the blockade of acetylcholine receptors (AChRs) at the neuromuscular endplate by circulating autoantibodies, followed by local complement activation and destruction of acetylcholine receptors (Stangel et al, *J. Neurol. Sci.* 153(2):203–14 (1998)). AChR is expressed on regenerating myoblasts but in normal adult muscle the AChR is only expressed at the motor endplate. In patients with early onset MG however the thymic medulla is infiltrated by lymph node-like T cells and germinal centres and there are myoblast-like myoid cells in the thymic medulla which express AChR. Therefore the presentation of the AChR antigen by these cells or by myoblasts is likely to be involved in the disease process (Curnow et al, *J. Neuroimmunol.* 115(1–2):127–134 (2001)). In studies of experimental autoimmune myasthenia gravis (EAMG) the Th1 cytokine, INF- $\gamma$ , has been shown to be involved in disease progression and has been reported to be capable of inducing the production by myoblasts of class I and II major histocompatibility antigens, AChR and ICAM-1. IL-1 has

also been shown to play a role in EAMG where disruption of the IL-1 beta gene was shown to diminish acetylcholine receptor-induced responses (Garcia et al, *J. Neuroimmunol* 120(1–2):103–11 (2001); Stegall et al, *J. Neuroimmunol.* 119(2):377–386 (2001)).

The causes of inflammatory muscle diseases dermatomyositis, polymyositis and inclusion body myositis (IBM) are unknown, but immune mechanisms are strongly implicated. Although clinically and immunopathologically distinct, these diseases share three dominant histological features: inflammation, fibrosis and loss of muscle fibres. In dermatomyositis, the endomysial inflammation and muscle fiber destruction is preceded by activation of the complement system of plasma proteins, and deposition of membranolytic attack complex on the endomysial capillaries (Dalakas, *Curr. Opin. Pharmacol.*1(3):300–306 (2001)). There is evidence that this attack may also involve the blood vessels in the dermis (Dalakas et al, *Curr. Opin. Pharmacol.* 9(3):235–239 (1996)). Transforming growth factor beta, shown to be overexpressed in the perimysial connective tissue in dermatomyositis, is down-regulated after successful immunotherapy and reduction of inflammation and fibrosis (Dalakas, *Arch. Neurol.* 55(12):1509–1512 (1998)).

In polymyositis and IBM the disease begins with the activation of CD8<sup>+</sup> T cells. These cytotoxic T cells reach the endomysial parenchyma to recognise muscle antigen(s) associated with the upregulation of the major histocompatibility complex (MHC) I on muscle fibres. The autoinvasive T cells exhibit gene rearrangement of their T-cell receptors (TCR) and are specifically selected and clonally expanded in situ by heretofore previously unknown antigens. Muscle cells do not normally express MHC I and II but in cases of polymyositis and IBM over expression of MHC is an early event that can be detected even in areas remote from the inflammation. INF $\gamma$  and TNF $\alpha$ , cytokines that induce MHC, have been found in patients with active polymyositis (Dalakas, *Curr. Opin. Pharmacol.* 1(3):300–306 (2001)).

No signs of apoptosis have been detected in patients with inflammatory myopathies and in fact two strong anti-apoptotic molecules have recently been found to be expressed in the muscle fibers. One is the Fas-associated death domain-like IL-1-converting enzyme inhibitory protein (FLIP) and the other human IAP (inhibitor of apoptosis protein)-like protein. The result of unsuccessful apoptotic clearance of inflammatory cells is likely to be the cause of the sustained chronic cytotoxic muscle fiber damage (Vattemi et al, *J. Neuroimmunol.* 111(1–2):146–151 (2000)).

Sarcoidosis is a multisystem chronic disorder with unknown cause and a worldwide distribution. Neurosarcoidosis is a complication of sarcoidosis involving inflammation and abnormal deposits in the tissues of the nervous system. Sudden, transient facial palsy is common with involvement of cranial nerve VII. Other manifestations include aseptic meningitis, hydrocephalus, parenchymatous disease of the central nervous system, peripheral neuropathy and myopathy. Intracranial sarcoid may mimic various forms of meningitis, including carcinomatous and intracranial mass lesions such as meningioma, lymphoma and glioma, based on neuroradiological imaging. A lumbar puncture may show signs of inflammation. Elevated levels of angiotensin converting enzyme may be found in the blood or CSF.

Therapy consists of immunosuppressive agents and corticosteroids (Nowak et al, *J. Neurol.* 248(5):363–372 (2001); Stern et al, *Arch. Neurol.* 42(9):909–917 (1985)).

Vascular dementia (VaD) is the general term for dementia caused by organic lesions of vascular origin, such as cerebral infarction, intracerebral haemorrhage or ischemic changes in subcortical white matter. It is the most frequent cause of dementia after AD accounting for about 20% of cases and 50% in subjects over 80 years (Dib, *Arch. Gerontol. Geriatr.*33(1):71–80 (2001); Parnetti et al, *Int. J. Clin. Lab Res.* 24(1):15–22 (1994)). The clinical distinction between AD and VaD may be difficult and there are standard guidelines for research studies. VaD and AD can co-exist as “mixed dementia” where the presence of cerebrovascular disease may worsen Alzheimer dementia. Traditionally AD is characterized by the insidious onset of memory loss, followed by a gradual progression to dementia in the face of normal findings on neurological examination. VaD on the other hand, is characterized by stepwise cognitive decline punctuated by episodes of stroke that are accompanied by focal deficits on neurological examination, and evidence of stroke on computed topography (CI) or magnetic-resonance imaging (Jagust, *Lancet* 358(9299):2097–2098 (2001)). It is assumed that the risk factors for stroke and vascular disease are also factors for VaD. These include hypertension, smoking, diabetes, obesity, cardiac rhythm disorders, hyperlipidaemia, hypercholesterolaemia and hyperhomocysteinaemia. The apolipoprotein E4 genotype is also considered as a risk factor for VaD, AD and ischemic stroke (Dib, *Arch. Gerontol. Geriatr.* 33(1):71–80 (2001)). Current treatments of vascular dementia include anti-platelet agents and/or surgery, and the treatment of cognitive symptoms (Parnetti et al, *Int. J. Clin. Lab. Res.* 24(1):15–22 (1994)).

Head trauma is associated with a variety of physiological and cellular phenomena such as ischemia, increased permeability of the blood-brain barrier (BBB), edema, necrosis and motor and memory dysfunction (Moor et al, *Neurosci. Lett.* 316(3):169–172 (2001); Shohami et al, *J. Neuroimmunol.* 72(2):169–177 (1997)). Ischemia caused by the initial brain injury induces a cascade of secondary events and the release of excitatory amino acids (EAA) such as glutamate and aspartate. Alteration in the levels of ions and neuromodulators lead to oxidation and cellular membrane damage and ultimately cellular death (Stahel et al, *Brain Res. Rev.* 27(3):243–256 (1998)). Experimental models for closed head injury (CHI) developed in the rat show the spatial and temporal induction of IL-1, IL-6 and TNF- $\alpha$  gene mRNA transcription along with an induction of IL-6 and TNF- $\alpha$  activity in the rat brain (Shohami et al, *J. Neuroimmunol.* 72(2):169–177 (1997)). IL-1 $\beta$  has also been shown to be released and it is the presence of these cytokines along with damage to endothelial cells that result in disruption of the BBB integrity. This disruption allows the recruitment of neutrophils into the subarachnoid space (Stahel et al (1998)).

TNF- $\alpha$  has been identified in the brain in several pathological conditions and inhibitors of TNF- $\alpha$  such as dexamethasone (DEX) have been shown to improve neurological outcome following CHI (Shohami et al, *J. Neuroimmunol.* 72(2):169–177 (1997)).

Cerebral vasospasm is delayed onset cerebral artery narrowing in response to blood clots left in the subarachnoid space after spontaneous aneurysmal subarachnoid hemorrhage (SAH) (Ogihara et al, *Brain Res.* 889(1–2):89–97 (2001)). It is angiographically characterized as the persistent luminal narrowing of the major extraparenchymal cerebral arteries and affects the cerebral microcirculation and causes decreased cerebral blood flow (CBF) and delayed ischemic neurological deficits. A number of studies have demonstrated morphological changes in cerebral arteries after SAH. Smooth muscle cells showed necrotic changes, such as dense bodies, degeneration of mitochondria, condensed lysosomes and dissolution of nuclear substances and the appearance of cell debris (Sobey et al, *Clin. Exp. Pharmacol. Physiol.* 25(11):867–876 (1998)). The impaired dilator and increased constrictor mechanisms that occur after SAH may be caused by oxyhaemoglobin produced by erythrocytes that inactivates NO in the subarachnoid space. Alternatively it may be due to an impaired activity of soluble guanylate cyclase resulting in reduced basal levels of cGMP in cerebral vessels and so a reduced responsiveness to NO (Ogihara et al, *Brain Res.* 889(1–2):89–97 (2001)). Production of IL-6 and IL-8 in the cerebrospinal fluid following SAH has also been demonstrated. It is thought that IL-6 may play a particular role in vasospasm as in induced vasoconstriction in a canine cerebral artery (Osuka et al, *Acta Neurochir* 140(9):943–951 (1998)).

Duchenne muscular dystrophy (DMD) is one of the most common, inherited, lethal disorders in childhood. It is an X-linked neuromuscular disease that affects 1 in 3500 males. Progressive muscle weakness begins between 2 and 5 years of age and ultimately leads to premature death by respiratory or cardiac failure during the middle to late twenties. Approximately 30% of cases are due to spontaneous mutation of the dystrophin genes while the remainder are inherited (Spencer et al, *Neuromuscul. Disord.* 11(6–7):556–564 (2001)). DMD patients therefore lack the protein dystrophin which is an essential link in the complex of proteins that connect the cytoskeleton to the extracellular matrix (Alderton et al, *Trends Cardiovascular Med.* 10(6):268–272 (2000)). Although gene therapy is the only cure for DMD it is believed that immune interventions may slow the progress of the disease. The reason for this is that there is evidence that immune cell interactions with dystrophin-deficient muscle can contribute to cell death in dystrophinopathies. It has also been shown that the population of immune cells in dystrophic muscle are not only different from those found that invade mechanically-damaged tissue; they are similar to those found in inflammatory disease such as polymyositis. Current research indicates that T cells may play a role in the pathology of dystrophin deficiency and that there may be an autoimmune component to the disease in which T cells are activated by a common antigen (Spencer et al, *Neuromuscular Disord.* 11(6–7):556–564 (2001)).

## Invention

This invention is directed to the surprising and unexpected discovery that such immune modulation therapy can exert beneficial anti-inflammatory effects across the blood-brain barrier of a mammalian patient, apparently through a significant reduction of the accumulation of reactive oxygen species and/or a significant down-regulation of associated inflammatory cytokines such as TNF- $\alpha$ , particularly in the

cortical tissue of mammals. Accordingly, the therapy is suitable for either prophylactic or therapeutic treatment of the inflammatory component of neurological brain diseases such as Down's syndrome, epilepsy, Huntington's disease and brain traumas, through mediation of the development or activity of reactive oxygen species which play a role in the development or manifestation of such inflammation.

The present invention also provides for a method for the prophylactic or therapeutic treatment of inflammatory components and inflammatory aspects of a neurological disease in a mammalian patient diagnosed with or at risk of a neurological disease, which method comprises:

- administering to said patient an aliquot of blood which has been treated ex vivo with at least two stressors selected from the group consisting of an oxidative environment, thermal stress and electromagnetic radiation, wherein the concentration of the reactive oxygen species in neuronal cells or tissues of said patient is reduced, with associated reduction of harmful inflammatory effects therein.

From another aspect, the present invention provides a process for alleviating the symptoms of a neurological brain disorder having a significant inflammatory component associated with excess active oxygen species (reactive oxygen species and oxidative free radicals), such as Down's syndrome, Huntington's disease, epilepsy and brain traumas, which comprises scavenging of active oxygen species from the brain of a mammalian patient by administering to said patient an aliquot of blood which has been treated ex vivo with at least two stressors selected from the group consisting of an oxidative environment, thermal stress and electromagnetic radiation.

Accordingly, the present invention is also a method of alleviation, prophylaxis against or preconditioning to hinder the onset and progression of neurodisorders which have a significant inflammatory component, such as Guillain-Barré syndrome (GBS), chronic inflammatory demyelinating polyneuropathy (CIDP), myasthenia gravis (MG), dermatomyositis, polymyositis, inclusion body myositis, post stroke, neurosarcoidosis, vascular dementia, closed head trauma, vasospasm, subarachnoid hemorrhage, adrenal leukocytic dystrophy (storage disorders), inclusion body dermatomyositis, minimal cognitive impairment and duchenne muscular dystrophy, wherein said method comprises treating a patient suffering from or at risk to contract such a disorder and having impaired endothelial function at the blood vessels, to improve the performance of endothelial function at the blood-brain barrier or at the blood-nerve barrier towards restoration of normal endothelial function. This represents a novel and innovative approach to the management and treatment of neurological disorders.

## P 14 Skin Ulcers and expression of TGF- $\beta_1$

### Transforming Growth Factor Regulation

July 11, 2002 US 2002/0090359 A1

#### BACKGROUND OF THE INVENTION

[0003] Transforming growth factor  $\beta_1$  (TGF- $\beta_1$ ), is a cytokine secreted by various mammalian cells, including macrophages, dendritic cells and tissue cells. It appears to play a significant role in the operation of the immune system, by interaction with other component cells thereof after its secretion. The mammalian immune system comprises lymphocytes (one type of white blood cell), the major components of which are B cells, which mature within the bone marrow, and T cells, which migrate from the bone marrow to mature in the thymus gland. B cells react to antigens to proliferate and differentiate into memory B cells and effector B cells which generate and express antibodies specific to the antigen, thereby removing the antigen from the host. T cells have T cell receptors which recognize antigen associated with MHC molecules on a cell, and as a result of this recognition differentiate into memory T cells and various types of effector T cells. The T cell population is made up of T-helper ( $T_H$ ) cells and T-cytotoxic ( $T_c$ ) cells, distinguished from one another by the presence of surface membrane glycoprotein CD4 on  $T_H$  cells and surface membrane glycoprotein CD8 on  $T_c$  cells. Activation of a  $T_H$  cell can cause it to secrete various growth factors (cytokines). Different types of  $T_H$  cells secrete different cytokines. Cytokines, including TGF- $\beta_1$  play key roles in the immune response, including autoimmune responses, often by interacting with other cells to stimulate them into greater production of other cytokines or, conversely, to downregulate them to produce lesser amounts of other cytokines. They can also affect the differentiation and proliferation of cells such as T-cells, to change the population distribution of the various types of T-cells.

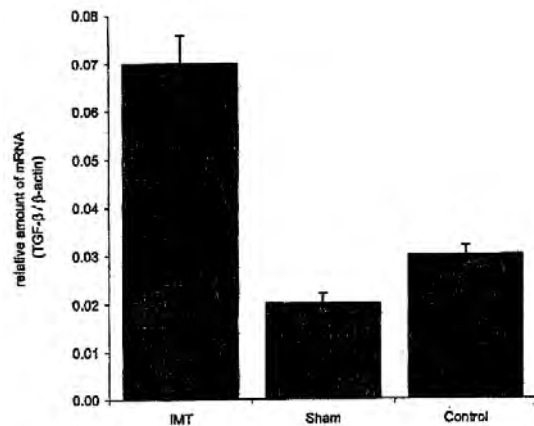


FIG. 1

[0004] While the precise mechanism of action of TGF- $\beta_1$  is not fully understood, it is known that TGF- $\beta_1$  has various effects on the operation of the immune system. It appears to promote a switch in  $T_H$  cell type, from  $T_H$  1 to  $T_H$  2, a switch which has benefits in alleviating or hindering the development of autoimmune diseases. It appears to have a role in angiogenesis, suggesting that its presence will have beneficial effects on rates of ulcer healing in the mammalian body.



[0005] A process or a medication which would promote the expression of the cytokine TGF- $\beta_1$  in a mammalian body would accordingly offer significant benefits to mammalian patients suffering from one or more of a variety of different disorders. It also promotes the healing of ulcers, for example venous ulcers, diabetic ulcers, gastric ulcers, duodenal ulcers, decubitus ulcers, etc. (Danno et.al., "Photodermatol Photoimmunol Photomed Dec. 17, 2001 (6):261-5; Zhou, L J, et.al., Br J Dermatol 2000 September;143(3):506-12;). prolonged pressure and are common in situations where the patient remains in a fixed position for prolonged periods (e.g., long term bed confinement).

[0006] In particular, decubitus ulcer formation in nutrient deprived surface skin areas is facilitated by skin irritation due to moisture, friction, and shearing forces. Typically, decubitus ulcer formation is preceded by reddening of nutrient deprived skin which, with continued irritation, develops into the bedsore (i.e., a skin ulcer).

[0007] Diabetic ulcers are formed by deprivation of nutrients to the surface skin as a result of the diabetic condition including neuropathy, poor circulation in the patient, etc. In particular, diabetic ulcer formation in nutrient deprived surface skin areas is facilitated by skin irritation due to moisture, friction, and shearing forces. Typically, diabetic ulcer formation is preceded by reddening of nutrient deprived skin which, with continued irritation, develops into a skin ulcer.

[0008] Accordingly, it is an object of the present invention to provide a process whereby the expression of the cytokine TGF- $\beta_1$  in a mammalian body may be promoted and increased.

[0009] It is a further object to provide a composition of matter for administration to a mammalian patient for promoting expression of the cytokine TGF- $\beta_1$  in the patient's body.

[0010] It is a further object of the present invention to provide a process and composition useful in treating and accelerating the healing of ulcers in a mammalian patient.

## SUMMARY OF THE INVENTION

[0011] The present invention provides a process whereby expression of the cytokine TGF- $\beta_1$  is promoted in a mammalian patient body. The process involves introducing blood cells into the patient which cells have been extracorporeally stressed by subjecting the blood cells to an oxidative stress and/or ultraviolet radiation. When these stressed blood cells are introduced to the patient, they appear to have the effect of promoting the expression of TGF- $\beta_1$ , either by activating and upregulating one of the types of mammalian cells which naturally express it, or by increasing the relative population of such cells, or both. Whatever the precise mechanism of action, the result is a significant and measurable increase in TGF- $\beta_1$  levels in the patient's system. Accordingly, the process of the invention is useful for the medical treatment of patients suffering from, prone to, or at risk of contracting a disorder associated with insufficient amounts of TGF- $\beta_1$ .

It also provides a process of accelerating the healing of wounds. Since increased levels of TGF- $\beta_1$  are found in the dermis of human patients who have been given treatments according to the invention, the process is particularly indicated for the healing of skin ulcers, such as decubitus ulcers, diabetic ulcers and the like.

[0012] Thus according to the present invention, there is provided a process of increasing the expression of TGF- $\beta_1$  by cells in a mammalian patient, which comprises administering to the patient an effective amount of stressed mammalian blood cells, said stressed cells having been extracorporeally subjected to at least one stressor selected from oxidative stress and ultraviolet radiation.

[0013] From another aspect, the present invention provides a composition of matter for administration to a mammalian patient to raise the levels of expressed TGF- $\beta_1$  in the patient's system, wherein said composition comprises stressed blood cells from the patient, the cells having been stressed by subjecting them extracorporeally to at least one stressor selected from oxidative stress and ultraviolet light.

# P 15 Vasoconstriction and vasospastic disorders

US6696092 B2

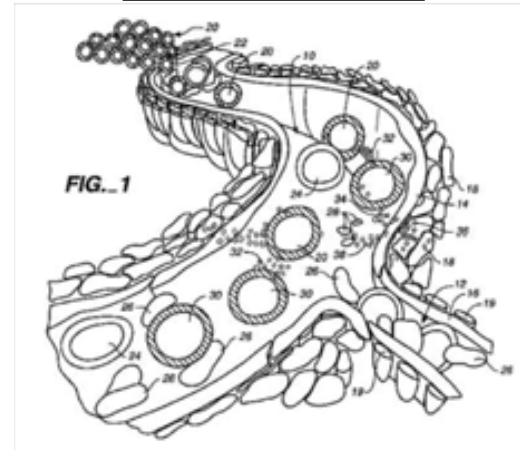
## BACKGROUND OF THE INVENTION

The control and regulation of blood flow through the cardiovascular system of a mammal is well recognized to be of importance in connection with cardiovascular disorders such as atherosclerosis, peripheral vascular disease and many other circulatory disorders. There is an emerging body of literature which indicates that the endothelium plays a major role in the regulation of blood flow through the cardiovascular system. The endothelium is a cellular structure which lines the blood vessels, communicating with the smooth muscle layer of the blood vessel walls. Contraction of this muscle layer causes the blood vessels to constrict (vasoconstriction), and relaxation of this muscle layer causes the blood vessels to expand (vasodilation). A normally functioning endothelium effectively controls the smooth muscles of the vessel wall, by secreting vasodilators or vasoconstrictors which diffuse or are carried to the muscle fibres to cause the muscle fibres either to relax or to contract. One such vasodilator secreted by the endothelium is commonly referred to as "endothelium derived relaxing factor" (EDRF), but has recently been established to be nitric oxide, a form thereof or a closely related compound. In addition to regulating blood flow, nitric oxide is recognized as having many other actions within the body, including neurotransmission, a smooth muscle controlling function within the gastrointestinal tract, both natural and drug induced analgesia, a role in impotence and in tumour toxicity.

It is believed that defective functioning of the endothelium of a patient is an underlying factor in many cardiovascular diseases observed in mammalian patients. For example, a patient with atherosclerosis has excessive quantities of lipid underlying the endothelium, including oxidized low density lipoprotein (containing cholesterol) which is believed to interfere with the proper functioning of the endothelial cells.

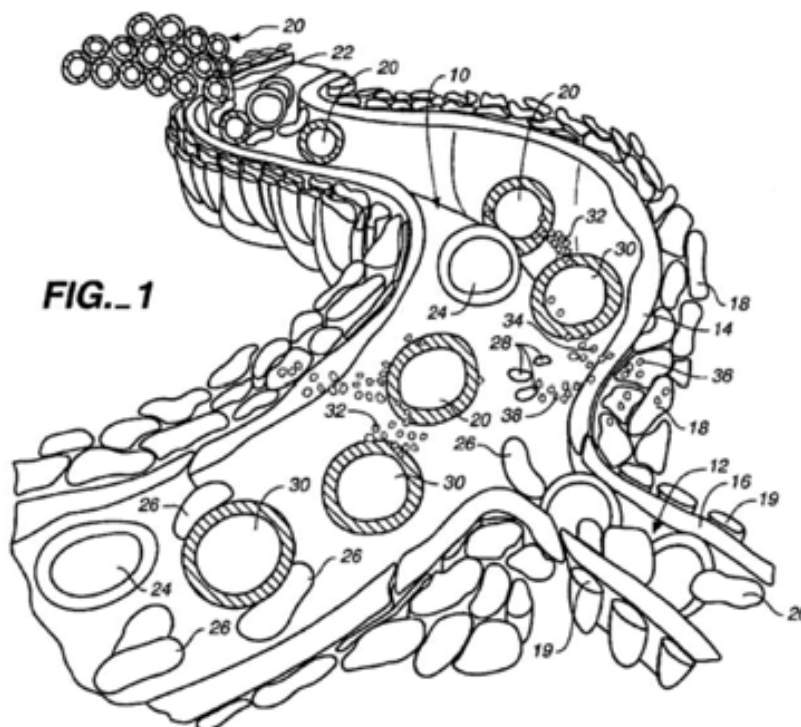
The effects of the modified leukocytes of the present invention, when re-injected into the mammalian patient's body, are several in number. Firstly, there is an effect on other leukocytes or their progenitors which have not been modified by the externally applied stressors, as a result of cell-to-cell communication, a widely recognised phenomenon among cells of the immune system. The result of injecting the blood subjected to stressors outside the body is the upregulation of specific cell surface markers such as HLA-DR and CD25 on other, non-treated leukocytes in the peripheral blood, circulating in the patient. This is indicative of an enhanced immune system. It appears that the treated leukocytes release cytokines (intercellular messenger peptides and proteins), or stimulate leukocytes of the recipient to do so, initiating a cascade phenomenon which affects a number of the quiescent leukocytes in the

See explanation of this picture below



peripheral blood and causes them to become stimulated. This apparently leads to improved blood flow at sites in the body far removed from the site of injection of the treated leukocytes.

Secondly, the stimulated leukocytes present in the blood circulation, perhaps through the intermediary of the same or similar cytokines and probably after physical contact or binding to the endothelium via cell adhesion molecules, act upon the endothelium, either directly or indirectly, to increase the endothelial vasodilator function probably by increasing the production and/or action of vasodilators such as nitric oxide, prostacyclin and/or by inhibiting the production and/or action of vasoconstrictors, so as to increase blood flow. This can be manifested either as a restoration of the function of a portion of the endothelium which has become defective, the portion being close to or remote from the site of injection. Such restoration of function may occur through repair of deficient cells or an enhanced rate of replacement of damaged cells. It can also be manifested as an overall improvement in endothelial function. This increased blood flow resulting from increased endothelial vasodilator function, and the consequent increase in oxygenation of tissues, is indicative of use of the process of the present invention in treatment of patients with vascular disease including those with advanced peripheral vascular disease, those with chronic varicose ulcers, and those at risk of developing gangrene which frequently results in amputation. In general, the leukocytes according to the present invention are indicated for use in treating any type of vascular disease either involving partial or complete blood vessel occlusion leading to restricted blood flow or dysfunction of the mechanisms required to permit adequate vasodilation such that tissues including those of the central nervous system, heart, lungs, gastrointestinal tract, liver, kidneys, placenta or extremities would be acutely or chronically affected in terms of structure or function.



#### DESCRIPTION OF THE PREFERRED EMBODIMENTS

With reference to the FIG. 1, there is diagrammatically illustrated an arteriole 10. An arteriole is a blood vessel forming part of the mammalian vascular system, of a size smaller than an artery, and which receives circulating blood from an artery, fed from the heart. Arterioles gradually decrease in size, in the downstream

direction. A metarteriole **12**, which is a smaller terminal branch of the arteriole **10**, is shown branching off the arteriole **10**. Metarterioles such as **12** lead to capillaries which are the site of nutrient and gaseous exchange between the blood and the tissues, with oxygen diffusing from the blood to the tissues and carbon dioxide diffusing from the tissues to the blood. The arteriole **10** is lined with a cellular layer of endothelium **14**. Surrounding the exterior of the arteriolar endothelium **14** is a layer of smooth muscle **18**, which can contract or expand to cause alterations in the size of the arteriole **10**, causing either vasodilation to increase the amount of blood flow therethrough or vasoconstriction to reduce the amount of blood flow therethrough. The metarteriole **12** is similarly lined with endothelium **16** and has a single layer of smooth muscle **19**, functioning similarly.

As in the case of all the other blood vessels in the body, of all the various sizes, capillaries are lined with endothelium. However, there is no smooth muscle layer associated with the capillaries.

According to the preferred process of the present invention, an aliquot of blood, or the separated cellular fractions of the blood, or mixtures of the separated cells, including platelets, is extracted from the patient and treated with certain stressors, described in more detail below. The effect of the stressors is to modify leukocytes in the aliquot. These modified leukocytes **20**, along with the rest of the aliquot, are re-injected intramuscularly and, after a period within the muscle, of uncertain and probably variable duration, they probably gain entry to the general circulation by passing through the blood vessel wall, where mixing with the blood occurs. Downstream from the point of entry **22**, therefore, the blood will contain modified leukocytes **20** in addition to unmodified leukocytes **24**, red blood cells **26** and platelets **28**, as well as other components.

The injection of modified leukocytes **20** appears to have a number of unexpected effects on the arteriole **10** and on the blood flowing through it. One effect is the stimulation of quiescent leukocytes **24**, which have not been subjected to the stressors outside the body, to transform into stimulated leukocytes **30**. This activation process may occur in sites other than the blood vessels, for example in immune system organs such as lymph nodes, spleen or bone marrow, and may involve leukocyte progenitors in addition to or alternatively to mature leukocytes. Thus a cascade mechanism is set in motion. This is believed to be effected by the secretion of certain cytokines **32**, the precise nature of which is uncertain, either from the modified leukocytes **20** themselves or by the stimulation of endogenous leukocytes **30** by direct cell—cell interaction. These mechanisms serve to effect stimulation of previously quiescent leukocytes or progenitors to create the stimulated leukocytes **30**. The stimulated leukocytes **30** probably adhere to the damaged endothelial cells via cell adhesion molecules such as ICAM-1 expressed on the endothelial cells interacting with activated LPA-1 expressed on certain activated leukocytes. Other cytokines **34**, perhaps originating from these adherent leukocytes and which may in fact be the same as or different from the cytokines **32**, contact the endothelium **14**, and cause it to secrete vasodilators **36** which have the effect of relaxing the smooth muscle **18** to cause a degree of vasodilation. Other secretions **38** released from the endothelium **14** by the cytokines **34**, which may or may not be the same substances or mixture of substances as the vasodilators **36**, contact the

platelets **28**, and have the effect of inhibiting their ability to aggregate. Whilst the accompanying figure diagrammatically illustrates endothelial effects at the endothelium of an arteriole of the vascular system, it appears that the process of the invention has a similar effect on endothelial cells at all levels of the vascular tree.

It is believed that one of the components of the vasodilators **36**, and one of the components of the secretions **38**, is endothelium derived relaxing factor EDRF, probably nitric oxide or closely related substances, and a second component is prostacyclin. Alternative or additional sources of nitric oxide and/or other vasodilators resulting from a treatment according to the present invention may be stimulated leukocytes present in the circulation or stimulated platelets present in the circulation.

The stressors to which the leukocytes are subjected ex vivo according to the invention are selected from temperature stress (blood temperatures above or below body temperature), an oxidative environment and ultraviolet radiation, individually or in any combination, simultaneously or successively. The leukocytes are subjected to the stressors as a part of an aliquot of mammalian blood

**P# 16**

## **ENDOTHELIN-RELATED DISORDERS**

**Dec 16, 2004** US 2004/0253213 A1

primary pulmonary hypertension (PPH), glaucoma, progression of atherosclerosis

### **BACKGROUND OF THE INVENTION**

[0005] Endothelins are a family of 21 amino acid peptides produced by endothelial cells. There are three known isoforms of endothelin, namely endothelin-1 (ET-1), endothelin-2 (ET-2) and endothelin-3 (ET-3). Of the three known isoforms, ET-1 is the major isoform produced by the vascular endothelium and is an extremely potent vasoconstrictor, with veins being 3 to 10 times more sensitive to the effects of ET-1 than arteries.

[0006] The vasoconstricting effect of endothelin is caused by the binding of endothelin to its receptor on the vascular smooth muscle cells. Thus far, two endothelin receptors have been characterized in mammalian species, known as the ETA and ETB receptors. The ETA receptor, restricted to vascular smooth muscle, is relatively selective for ET-1 and mediates vasoconstriction. The ETB receptor, primarily located in the endothelium, mediates vasodilatation through the production of endothelium-dependent vasodilators, such as nitric oxide and prostacyclin.

[0007] A pathophysiological role for the endothelins has been postulated in a large number of human disease states.

[0008] One example of such a disease state is primary pulmonary hypertension (PPH), a rare condition of unknown etiology which affects mainly young people. PPH causes progressive shortening of breath and most of those affected are dead within 4 years of diagnosis. Patients with PPH have increased circulating endothelin levels which may be caused by increased pulmonary endothelin synthesis, and there is evidence to suggest that increased endothelin production may be directly involved in the pathogenesis of PPH (Ferro and Webb, "The Clinical Potential of Endothelin Receptor Antagonists in Cardiovascular Medicine", *Drugs* 1996 January; 51(1): 12-27).

[0009] Another example of such a disease state is glaucoma, which is a group of vascular disorders characterized by degeneration of the optic nerve which carries images from the retina to the brain. The disease is associated with high intraocular pressure and impaired ocular blood flow. There are reports in the literature that ET-1 plasma levels are elevated in some forms of glaucoma (Cellini et al., "Color Doppler imaging and plasma levels of endothelin-1 in low-tension glaucoma": *Acta Ophthalmol Scand Suppl* 1997; (224): 11-3). Furthermore, endothelin appears to be involved in the regulation of intraocular pressure and the modulation of ocular blood flow

(Haefliger et al., "Potential role of nitric oxide and endothelin in the pathogenesis of glaucoma", 1: Surv Ophthalmol 1999 June; 43 Supl 1: S51-8; and Sugiyama et al., "Association of endothelin-1 with normal tension glaucoma: clinical and fundamental studies" 6: Surv Ophthalmol 1995 May; 39 Suppl 1: S49-56), suggesting that endothelin may be involved in the pathogenesis of at least some forms of the disease.

[0010] Endothelin also plays a potential role in the progression of atherosclerosis (Rubanyi and Polokoff, "Endothelins: Molecular Biology, Biochemistry, Pharmacology, Physiology and Pathophysiology", Pharmacological Reviews Vol. 46, No. 3, 1994, pp. 325-415) incorporated herein by reference. This is supported by a number of factors, including the following: plasma ET-1 levels are elevated in patients with atherosclerosis and in animal models of hypercholesterolemia; expression of the ET-1 gene is induced, synthesis and release of ET-1 peptide is increased, and binding of exogenous ET-1 is enhanced in the atheromatous vascular lesion; ET-1 production by the endothelium and macrophages is stimulated by oxidized LDL and several cytokines involved in the vascular injury process; and ET-1-induced vasoconstriction is potentiated in atherosclerosis.

[0011] Endothelin 1 (ET-1) is also a factor in promotion of angiogenesis, the development of blood vessels, a process which, properly balanced, is important in the restoration and maintenance of good health in mammals. Excess angiogenesis, however, can cause serious health problems, e.g. in recovery from cardiac incidents and in restenosis. ET-1 is known to stimulate the secretion of vascular endothelial growth factor VEGF (see for example Spinella, F. et. al., J. Biol. Chem. 2002 Aug. 2; 277 (31): 27850-5), which promotes angiogenesis. Down-regulation of ET-1 is therefore the basis of potential treatments of conditions involving excess angiogenesis.

[0012] Although the symptoms of many endothelin-related disorders can be treated, there is a lack of available treatments which address the underlying role of endothelin in these disorders. Accordingly, the need exists for an effective treatment of endothelin-related disorders.



## BACKGROUND OF THE INVENTION

Chronic lymphocytic leukemia (hereinafter CLL) is one of the four major types of leukemia encountered by humans, the others being acute lymphocytic leukemia, acute myeloid leukemia and chronic myeloid leukemia. CLL is most commonly encountered in patients over the age of sixty. It has a gradual onset, and may not cause the patient discomfort or pain for several years. It is characterized by a large number of cancerous mature lymphocytes and enlarged lymph nodes. Cancerous cells crowd out the normal cells in the bone marrow and lymph nodes. Anemia develops in the patient and the number of normal white cells and platelets in the patient's blood decreases, whereas the total white cell count increases due to the proliferation of abnormal white cells. The level and activity of antibodies also decrease. As a result, the patient's immune system becomes compromised. It is more common for CLL sufferers to die from consequences of the compromised immune system, e.g. infections, than from the CLL itself.

The most common type of CLL is a B cell leukemia, and the malignant cell of origin is a CD5+B cell, i.e. a B cell expressing the marker CD5.

Clinical stage of CLL, characterized in the staging systems of Rai (stages O-IV) and Binet (stages A-C), remains the strongest predictor of survival in CLL patients. Both systems are based on the amount of involved lymphoid tissue and the presence of anemia and/or thrombocytopenia. In general, patients with later stages have a significantly worse prognosis and a shorter survival. Patients with Rai stage IV or Binet stage C have a median survival of only 1.5 to 2 years.

Chemotherapy (initially with alkylating agents such as chlorambucil and subsequently with fludarabine) is the standard treatment for CLL. A patient diagnosed with CLL is normally monitored by tracking the white cell count in the blood. Chemotherapy is not instituted until the patient starts to suffer symptoms such as fatigue, weight loss, fevers or pain as a result of the progression of the CLL. However, CLL is not curable with conventional methods of chemotherapy, even though initial response rates are high. The toxicities associated with the use of chemotherapy are well known and include nausea and myelosuppression with a risk of developing serious infections. Moreover, subsequent responses become inexorably short-lived, likely because drug-resistant tumor cells are selected by the use of cytotoxic agents.

Accordingly, it is an object of the present invention to provide novel procedures and compositions for alleviation of CLL in mammalian patients.

It is a further object of the invention to provide procedures and compositions which, on suitable administration to a CLL suffering patient, will significantly postpone the need for subjecting the patient to chemotherapy.

## SUMMARY OF THE INVENTION

According to the present invention in its broad aspects, CLL in a mammalian patient is alleviated by administering to the patient oxidatively stressed CLL malignant cells. The source of the CLL malignant cells may be the mammalian patient himself or herself (e.g. a withdrawn blood sample from the patient), a compatible mammalian donor (e.g. a withdrawn blood sample from another, compatible CLL-suffering patient), or a cultured cell line of CLL malignant cells. Subjection of the CLL malignant cells to oxidative stress takes place in vitro. The oxidatively stressed CLL cells thus obtained are administered to the patient to result in an alleviation of the patient's CLL.

According to a preferred aspect of the present invention, CLL in a mammalian patient suffering therefrom is significantly alleviated by administering to the patient oxidatively stressed blood cells, including oxidatively stressed CLL malignant cells, obtained from the patient and subjected to oxidative stress in vitro and then reintroduced into the patient. The procedure thus involves extracting an appropriate quantity of blood containing CLL cells from the CLL patient, treating the blood or a selected portion of it extracorporeally with an oxidative stressor, and reintroducing it into the same patient. The result, after one or more of such treatments, is a significant alleviation of the patient's CLL condition, as indicated in a reduced white blood cell proliferation and a reduced swelling of lymph nodes of the patient.

Thus from one aspect, the present invention provides a process for treating a CLL suffering patient for alleviation of CLL, which comprises extracting an aliquot of blood containing CLL cells from the patient, subjecting at least a portion of the extracted blood cells extracorporeally to appropriate oxidative stress, and re-introducing the oxidatively-stressed material into the patient.

Another aspect of the present invention is oxidatively stressed mammalian CLL cells, useful for introduction into a mammalian patient suffering from CLL to alleviate the patient's CLL.

A further aspect of the present invention is the use in preparation of a medicament active against CLL in a mammalian patient, of oxidatively stressed autologous blood or blood fractions, including oxidatively stressed autologous malignant CLL cells.

Another aspect of this invention is a composition comprising stressed CLL cells. The cells may be oxidatively stressed and may further be autologous CLL cells.

While it is not intended that this invention should be limited to any particular mode of action or theory of mechanism or performance, it is postulated that appropriately oxidatively stressed blood cells activate the regulatory immune T cells controlling the CD5+B cells in the patient's blood, including the malignant CD5+B cells. The oxidatively stressed cells, on reintroduction into the CLL patient, are believed to activate certain T cells present in the patient's blood which then down-regulate the malignant CD5+B cells by acting directly on them or by secreting cytokines

which then act on them. In any event, the result is a significant reduction in the rate of proliferation of the malignant CD5+B cells in the CLL patient and a consequent alleviation of the CLL condition and its symptoms.

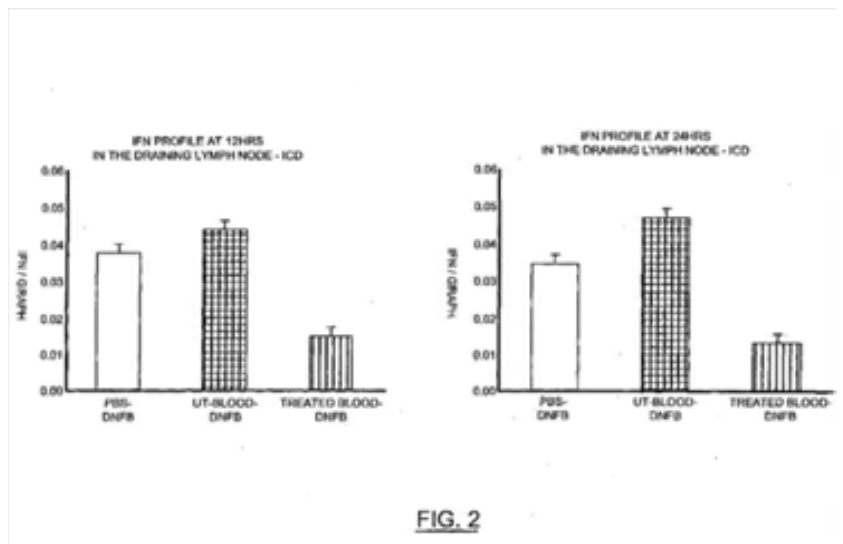
## ACUTE INFLAMMATORY CONDITION TREATMENT

June 12, 2008 US 2008/0138432 A1

### BACKGROUND OF THE INVENTION

“Acute inflammatory conditions” as the term is used herein, and in accordance with normal medical parlance, refers to inflammatory conditions having a rapid onset and severe symptoms. The duration of the onset, from a normal condition of the patient to one in which symptoms of inflammation are seriously manifested, is anything up to about 72 hours. Acute inflammatory conditions are to be contrasted with chronic inflammatory conditions, which are inflammatory conditions of long duration, denoting a disease showing little change or of slow progression. The distinction between acute and chronic conditions is well known to those in the medical professions, even if they are not distinguishable by rigid, numbers-based definitions.

It is known that many inflammatory conditions are associated with an abnormal secretion level of various cytokines in the mammalian body. Professional antigen-presenting cells (APCs), including dendritic cells and macrophages, actively capture and process antigens, clear cell debris, and remove infectious organisms and dying cells, including the residues from dying cells. During this process, APCs can stimulate the production of either inflammatory Th1 pro-inflammatory cytokines (IL-12, IL-1, TNF- $\alpha$ , IFN- $\gamma$ , etc); or regulatory, Th2/Th3 anti-inflammatory cytokines (IL-10, IL-4, TGF- $\beta$  etc) dominated responses, depending on the nature of the antigen or phagocytosed material and the level of APC maturation/activation.



### SUMMARY OF THE INVENTION

The present invention is based upon the discovery that blood treated with various stressors such as ozone, will, upon administration to a mammalian patient, cause a rapid decrease in the level of inflammatory cytokines such as TNF- $\alpha$ , IFN- $\gamma$  and IL-12, the effects being significant within the first twelve hours after the administration of the treated blood. Accordingly, the treated blood may

be used to treat acute inflammatory diseases and/or to delay and/or to ameliorate symptoms associated with such diseases.

# Auto Immune system, Inflammation and cytokines

## INFLAMMATORY CYTOKINE SECRETION INHIBITION

Jul. 11, 2002 US 2002/0090360

### BACKGROUND OF THE INVENTION

[0003] The mammalian immune system comprises lymphocytes (one type of white blood cell), the major components of which are B cells, which mature within the bone marrow, and T cells which migrate from the bone marrow to mature in the thymus gland. B cells react to antigens to proliferate and differentiate into memory B cells and effector B cells to generate and express antibodies specific to the antigen, thereby removing the antigen from the host. T cells have T cell receptors which recognize antigen associated with MHC molecules on a cell, and as a result of this recognition differentiate into memory T cells and various types of effector T cells. The T cell population is made up of T-helper ( $T_H$ ) cells and T-cytotoxic ( $T_C$ ) cells, distinguished from one another by the presence of the surface membrane glycoprotein CD4 on  $T_H$  cells and the surface membrane glycoprotein CD8 on  $T_C$  cells. Activation of a  $T_H$  cell can cause it to secrete various growth factors (cytokines). Different types of  $T_H$  cells secrete different cytokines. These cytokines play key roles in the immune response, including autoimmune responses.

[0004] One type of  $T_H$  cell, known as  $T_{H1}$ , expresses cytokines which, in excessive amounts, can cause inflammation in the mammalian body. Examples of such inflammatory cytokines include interferon- $\gamma$  (IFN- $\gamma$ ), interleukin-6 (IL-6) and interleukin-12 (IL-12). When the body produces inappropriately large amounts of inflammatory cytokines, significantly more than endogenous levels found in the corresponding non-diseased tissue of healthy individuals, either through over-activation of  $T_{H1}$  cells, activation of excessive numbers of  $T_{H1}$  cells, or a switch of other types of T cells to the  $T_{H1}$  type to create excessive numbers of cytokines expressing  $T_{H1}$  cells, an inflammatory disorder can manifest itself in a patient.

### SUMMARY OF THE INVENTION

[0005] The present invention provides a process whereby expression of inflammatory cytokines including IFN- $\gamma$  and IL-6, either individually or in combination, is reduced in a mammalian patient body. This process involves introducing blood cells into the patient which cells have been extracorporeally stressed by subjection to an oxidative stress and/or ultraviolet radiation. On introduction of these stressed blood cells, there is a reduction in the expression of one or more of these inflammatory cytokines, either by down regulating  $T_{H1}$  cells, or perhaps by decreasing the population of  $T_{H1}$  cells, e.g. by causing a switch of T cells from  $T_{H1}$  to  $T_H 2$ . Whatever the precise mechanism of action, the result is a significant and measurable decrease in these inflammatory cytokines in the patient's system. Accordingly, the process of the invention is useful in the medical treatment of patients suffering from, prone to, or at risk of contracting a disorder associated with excessive amounts of one or more of the inflammatory cytokines IFN- $\gamma$  and IL-

6(e.g., chronic fatigue syndrome—see Cannon et.al., *J. Clin. Immunol.* 19(6): 414-21, 1999; and Gupta, S. et.al., *Int. J. Mol.Med.* 3(2): 209-13, 1999).

[0006] Thus according to the present invention, there is provided a process of decreasing the expression of one or more of the inflammatory cytokines IFN- $\gamma$  and IL-6 by cells in a mammalian patient, which comprises administering to the patient an effective amount of stressed mammalian blood cells, said stressed cells having been extracorporeally subjected to at least one stressor selected from oxidative stress and ultraviolet radiation.

[0007] There is further provided a method for treating an inflammatory disease condition in a patient mediated by inflammatory cytokine production, which method comprises administering to the patient an effective amount of stressed mammalian blood cells wherein said stressed mammalian blood cells have been extracorporeally subjected to at least one stressor selected from oxidative conditions and ultraviolet radiation.

# Chronic Fatigue and a process of decreasing the expression of one or more of the inflammatory cytokines IFN- $\gamma$ and IL-6

**INFLAMMATORY CYTOKINE SECRETION INHIBITION** July 11, 2002 US 2002/0090360 A1

## BACKGROUND OF THE INVENTION

[0003] The mammalian immune system comprises lymphocytes (one type of White blood cell), the major components of which are B cells, which mature within the bone marrow, and T cells which migrate from the bone marrow to mature in the thymus gland. B cells react to antigens to proliferate and differentiate into memory B cells and effector B cells to generate and express antibodies specific to the antigen, thereby removing the antigen from the host. T cells have T cell receptors Which recognize antigen associated with MHC molecules on a cell, and as a result of this recognition differentiate into memory T cells and various types of effector T cells.

The T cell population is made up of T-helper (TH) cells and T-cytotoxic (Tc) cells, distinguished from one another by the presence of the surface membrane glycoprotein CD4 on TH cells and the surface membrane glycoprotein CD8 on Tc cells. Activation of a TH cell can cause it to secrete various growth factors (cytokines). Different types of TH cells secrete different cytokines. These cytokines play key roles in the immune response, including autoimmune responses.

[0004] One type of TH cell, known as TH1, expresses cytokines Which, in excessive amounts, can cause inflammation in the mammalian body. Examples of such inflammatory cytokines include interferon- $\gamma$  (IFN- $\gamma$ ), interleukin-6 (IL-6) and interleukin-12 (IL-12). When the body produces inappropriately large amounts of inflammatory cytokines, significantly more than endogenous levels found in the corresponding non-diseased tissue of healthy individuals, either through over-activation of TH1 cells, activation of excessive numbers of TH1 cells, or a switch of other types of T cells to the TH1 type to create excessive numbers of cytokines expressing TH1 cells, an inflammatory disorder can manifest itself in a patient.

## SUMMARY OF THE INVENTION

[0005] The present invention provides a process whereby expression of inflammatory cytokines including IFN- $\gamma$  and IL-6, either individually or in combination, is reduced in a mammalian patient body. This process involves introducing blood cells into the patient Which cells have been extracorporeally stressed by subjection to an oxidative stress and/or ultraviolet radiation. On introduction of these stressed blood cells, there is a reduction in the expression of one or more of these inflammatory cytokines, either by down regulating TH1 cells, or perhaps by decreasing the population of TH cells, eg by causing a switch of T cells from TH1 to TH2.

Whatever the precise mechanism of action, the result is a significant and measurable decrease in these inflammatory cytokines in the patient's system. Accordingly, the process of the invention is useful in the medical treatment of patients suffering from, prone to, or at risk of contracting a disorder associated with excessive amounts of one or more of the inflammatory cytokines IFN- $\gamma$  and IL-6 (e. g., chronic fatigue syndrome—see Cannon et.al., J. Clin. Immunol. 19(6): 414-21, 1999; and Gupta, S. et.al., Int. J. MolMea'. 3(2):

[0006] Thus according to the present invention, there is provided a process of decreasing the expression of one or more of the inflammatory cytokines IFN- $\gamma$  and IL-6 by cells in a mammalian patient, Which comprises administering to the patient an effective amount of stressed mammalian blood cells, said stressed cells having been extracorporeally subjected to at least one stressor selected from oxidative stress and ultraviolet radiation.



# METHODS FOR TREATING THE INFLAMMATORY COMPONENT OF A BRAIN DISORDER

Oct. 24, 2002 US 2002/0155098 A1

This invention is directed to methods for treating the inflammatory component of brain disorders in mammalian patients, and more particularly for treating those neurological brain disorders in which reactive oxygen species play a significant role in the underlying inflammatory pathology.

Understanding Brain and neurological inflammation

US 2002/0155098 A1

The events that lead to neurological disorders with a significant inflammatory component (including myasthenia gravis, GBS, CIDP, and multiple sclerosis) are not clear, but the following sequential steps appear to be critical. (1) The breaking of tolerance, a process in which cytokines, molecular mimicry, or superantigens may play a role in rendering previously anergic T-cells to recognize neural autoantigens. (2) Antigen recognition by the T-cell receptor complex and processing of the antigen via the major histocompatibility complex class I or II. (3) Costimulatory factors, especially B7 and B7-binding proteins (CD28, CTLA4) and intercellular adhesion molecule (ICAM-1) and its leukocyte function-associated (LFA)-1 ligand. (4) Traffic of the activated T cells across the blood-brain or blood-nerve barrier via a series of adhesion molecules that include selections, leukocyte integrins (LFA-1, Mac-1, very late activating antigen (VLA)-4) and their counter-receptors (ICAM 1, vascular cell adhesion molecule (VCAM)) on the endothelial cells. (5) Tissue injury When the activated T cells, macrophages, or specific autoantibodies find their antigenic targets on glial cells, myelin, axon, calcium channels, or muscle. [0006] In designing specific immunotherapy, the main components involved in every step of the immune response need to be considered. Targets for specific therapy in neurological disease include agents and treatments that

- interfere or compete With antigen recognition or stimulation;
- inhibit co-stimulatory signals or cytokines;
- inhibit the traffic of the activated cells to tissues; and
- intervene at the antigen recognition sites in the targeted organ.

[0007] Reactive oxygen species (ROS) are activated forms of oxygen, including superoxide anion (O<sub>2</sub><sup>-</sup>) and hydroxyl radicals together With hydrogen peroxide (H<sub>2</sub>O<sub>2</sub>) and various unstable intermediates of lipid peroxidation. They are generated as a result of aerobic metabolism. Neuronal brain tissue is particularly susceptible to oxidative damage due its to high consumption of oxygen and its limited antioxidant defense system. Reactive oxygen species formation is thought to have an impact on synaptic plasticity, cell signaling and the aging process. An age-related increase in reactive oxygen species production has been demonstrated (Martin et al., 2000) and the accumulation of reactive oxygen species has also been shown to be increased in the hippocampus as a consequence of peripheral LPS administration (Vereker et al., 2000a). This is mimicked by IL-1[3 administration (Vereker et al., 2000b). O'Donnell and colleagues (2000) have reported parallel changes in reactive oxygen species formation and IL-1[3 production; reactive oxygen species formation Was shown to cause an increase in IL-1[3 production While IL-1[3 has the ability to induce reactive oxygen species formation thus suggesting the existence of a positive feedback loop Which is potentially damaging to cells.

[0008] Increased concentrations of IL-1[3 have also been closely linked With neuronal degeneration (Mogi et al., 1996; Tenneti et al., 1998).

[0009] Enhanced activity of the stress-activated kinase c-Jun NHZ-terminal kinase (JNK) is associated With cell degeneration and death (Park et al., 1996; Maroney et al., 1998), and has been shown to be activated in the hippocampus by several agents, including hydrogen peroxide, an inducer of reactive oxygen species production, and pro-inflammatory cytokines.

[0010] Another example of a neuronal brain deficit induced by IL-1[3 and LPS, is the impairment of long term potentiation (LTP) in the hippocampus (Vereker et al 2000a; Murray & Lynch, 1998). LTP is a form of synaptic plasticity that Was originally described in the hippocampus, a brain region that is particularly vulnerable to degeneration which s associated With cognitive dysfunction. On the basis of this and other observations, LTP has been proposed as a biological substrate for learning and memory (Bliss & Collingridge, 1993).

[0011] Certain neurological brain disorders such as Downs syndrome (Layton et al., KedZiora et al., Schuchmann et. al.), epilepsy, brain trauma (e.g. physical damage to the brain such as concussion)(Layton et al., Wildburgur et al., Trembovler et al.) and Huntington's disease (chorea)(Green) are currently understood to involve inflammation of brain cells as a significant component of the underlying pathology of the disorder. This inflammation could be the consequence of one or more of a variety of biological processes, such as the generation of excess-amounts of inflammatory cytokines such as IL-1[3 and TNF- $\alpha$ , in the brain cells or other components of the brain tissue, perhaps associated With the presence of high concentrations of reactive oxygen species in the brain tissue, Which correlates to high levels of tissue damage or exacerbation of the disease. Reactive oxygen species are one of the effectors of inflammation in tissue such as brain tissue.

[0012] Other neurological disorders Which have a significant inflammatory component include Guillain-Barré syndrome (GBS), chronic inflammatory demyelinating polyneuropathy (CIDP), myasthenia gravis (MG), dermatomyositis, polymyositis, inclusion body myositis,

post stroke, neurosarcoidosis, vascular dementia, closed head trauma, vasospasm, subarachnoid hemorrhage, adrenal leukocytic dystrophy (storage disorders), inclusion body dermatomyositis, minimal cognitive impairment and duchenne muscular dystrophy.

[0013] Chronic inflammatory demyelinating polyneuropathy (CIDP) is a neurological disorder characterized by slowly progressive weakness and sensory dysfunction of the legs and arms. The disorder, which is sometimes called chronic relapsing polyneuropathy, is caused by damage to the myelin sheath of the peripheral nerves. CIDP can occur at any age and in both genders, is more common in young adults, and in men more so than women. The primary symptoms include slowly progressive muscle weakness and sensory dysfunction affecting the upper and lower extremities. Other symptoms may include fatigue; abnormal sensations including burning, numbness and/or tingling sensations (beginning in the toes and fingers); paralysis of the arms and/or legs; weakened or absent deep tendon reflexes (areflexia); and, aching pain affecting various muscle groups.

[0014] CIDP is closely related to the more common, acute demyelinating neuropathy known as Guillain-Barré syndrome (GBS). CIDP is considered the chronic counterpart of the acute disease GBS. CIDP is distinguished from GBS, chiefly by clinical course and prognosis. However, both disorders have similar clinical features, and both share the CSF albuminocytological dissociation and the pathological abnormalities of multi-focal inflammatory segmental demyelination with associated nerve conduction features reflecting demyelination.

[0015] Guillain-Barre Syndrome (GBS) is an acute predominantly motor polyneuropathy with spontaneous recovery that may lead to severe quadriplegia and requires artificial ventilation in 20-30% of patients. The diseases that underlie this syndrome have been classified as acute inflammatory demyelinating polyneuropathy (AIDP), the most common form, acute motor and sensory axonal neuropathy (AMSAN), and acute motor axonal neuropathy (AMAN). Fisher syndrome is a cranial nerve variant of GBS which characteristically results in ophthalmoplegia, ataxia and areflexia. GBS is often preceded by infection with either *Campylobacter jejuni*, which is most common, cytomegalovirus (CMV), Epstein-Barr virus or *Mycoplasma pneumoniae*.

[0016] Autoimmune myasthenia gravis (MG) is a disorder of neuromuscular transmission leading to fluctuating weakness and abnormal fatigability. Weakness is attributed to the blockade of acetylcholine receptors (AChRs) at the neuromuscular endplate by circulating autoantibodies, followed by local complement activation and destruction of acetylcholine receptors (Stangel et al, *J. Neural. Sci.* 153(2):203-14 (1998)). AChR is expressed on regenerating myoblasts but in normal adult muscle the AChR is only expressed at the motor endplate. In patients with early onset MG however the thymic medulla is infiltrated by lymph node-like T cells and germinal centres and there are myoblast-like myoid cells in the thymic medulla which express AChR. Therefore the presentation of the AChR antigen by these cells or by myoblasts is likely to be involved in the disease process (Curnow et al, *J. Neuroimmunol.* 115(1-2):127-134 (2001)). In studies of experimental autoimmune myasthenia gravis (EAMG) the Th2 cytokine, INF- $\gamma$ , has been shown to be involved in disease progression and has been reported to be capable of inducing the production by myoblasts of class I and II major histocompatibility antigens, AChR and ICAM-1. IL-1 has also been shown to play a role in EAMG where disruption of the IL-1 beta gene was shown to diminish acetylcholine receptor-induced responses.

[0017] The causes of inflammatory muscle diseases dermatomyositis, polymyositis and inclusion body myositis (IBM) are unknown, but immune mechanisms are strongly implicated. Although clinically and immunopathologically distinct, these diseases share three dominant histological features: inflammation, fibrosis and loss of muscle fibres. In dermatomyositis, the endomysial inflammation and muscle fiber destruction is preceded by activation of the complement system of plasma proteins, and deposition of membranolytic attack complex on the endomysial capillaries (Dalakas, *Curr. Opin. Pharmacol.* 1(3):300-306 (2001)). There is evidence that this attack may also involve the blood vessels in the dermis (Dalakas et al, *Curr Opin. Pharmacol.* 9(3):235-239 (1996)). Transforming growth factor beta, shown to be overexpressed in the perimysial connective tissue in dermatomyositis, is down-regulated after successful immunotherapy and reduction of inflammation and fibrosis (Dalakas, *Arch. Neural.* 55(12):1509-1512 (1998)).

[0018] In polymyositis and IBM the disease begins with the activation of CD8+ T cells. These cytotoxic T cells reach the endomysial parenchyma to recognize muscle antigen(s) associated with the upregulation of the major histocompatibility complex (MHC) I on muscle fibres. The autoinvasive T cells exhibit gene rearrangement of their T-cell receptors (TCR) and are specifically selected and clonally expanded in situ by heretofore previously unknown antigens. Muscle cells do not normally express MHC I and II but in cases of polymyositis and IBM over expression of MHC is an early event that can be detected even in areas remote from the inflammation. INF $\gamma$  and TNF $\alpha$ , cytokines that induce MHC, have been found in patients with active polymyositis (Dalakas, *Curr Opin. Pharmacol.* 1(3):300-306 (2001)).

[0019] No signs of apoptosis have been detected

Want more ? There are a total of 25

# Chronic lymphocytic leukemia

## BACKGROUND OF THE INVENTION

Chronic lymphocytic leukemia (hereinafter CLL) is one of the four major types of leukemia encountered by humans, the others being acute lymphocytic leukemia, acute myeloid leukemia and chronic myeloid leukemia. CLL is most commonly encountered in patients over the age of sixty. It has a gradual onset, and may not cause the patient discomfort or pain for several years. It is characterized by a large number of cancerous mature lymphocytes and enlarged lymph nodes. Cancerous cells crowd out the normal cells in the bone marrow and lymph nodes. Anemia develops in the patient and the number of normal white cells and platelets in the patient's blood decreases, whereas the total white cell count increases due to the proliferation of abnormal white cells. The level and activity of antibodies also decrease. As a result, the patient's immune system becomes compromised. It is more common for CLL sufferers to die from consequences of the compromised immune system, e.g. infections, than from the CLL itself.

The most common type of CLL is a B cell leukemia, and the malignant cell of origin is a CD5+B cell, i.e. a B cell expressing the marker CD5.

Clinical stage of CLL, characterized in the staging systems of Rai (stages O-IV) and Binet (stages A-C), remains the strongest predictor of survival in CLL patients. Both systems are based on the amount of involved lymphoid tissue and the presence of anemia and/or thrombocytopenia. In general, patients with later stages have a significantly worse prognosis and a shorter survival. Patients with Rai stage IV or Binet stage C have a median survival of only 1.5 to 2 years.

Chemotherapy (initially with alkylating agents such as chlorambucil and subsequently with fludarabine) is the standard treatment for CLL. A patient diagnosed with CLL is normally monitored by tracking the white cell count in the blood. Chemotherapy is not instituted until the patient starts to suffer symptoms such as fatigue, weight loss, fevers or pain as a result of the progression of the CLL. However, CLL is not curable with conventional methods of chemotherapy, even though initial response rates are high. The toxicities associated with the use of chemotherapy are well known and include nausea and myelosuppression with a risk of developing serious infections. Moreover, subsequent responses become inexorably short-lived, likely because drug-resistant tumor cells are selected by the use of cytotoxic agents.

Accordingly, it is an object of the present invention to provide novel procedures and compositions for alleviation of CLL in mammalian patients.

It is a further object of the invention to provide procedures and compositions which, on suitable administration to a CLL suffering patient, will significantly postpone the need for subjecting the patient to chemotherapy.

## SUMMARY OF THE INVENTION

According to the present invention in its broad aspects, CLL in a mammalian patient is alleviated by administering to the patient oxidatively stressed CLL malignant cells. The source of the CLL malignant cells may be the mammalian patient himself or herself (e.g. a withdrawn blood sample from the patient), a compatible mammalian donor (e.g. a withdrawn blood sample from another, compatible CLL-suffering patient), or a cultured cell line of CLL malignant cells. Subjecting of the CLL malignant cells to oxidative stress takes place in vitro. The oxidatively stressed CLL cells thus obtained are administered to the patient to result in an alleviation of the patient's CLL.

According to a preferred aspect of the present invention, CLL in a mammalian patient suffering therefrom is significantly alleviated by administering to the patient oxidatively stressed blood cells, including oxidatively stressed CLL malignant cells, obtained from the patient and subjected to oxidative stress in vitro and then reintroduced into the patient. The procedure thus involves extracting an appropriate quantity of blood containing CLL cells from the CLL patient, treating the blood or a selected portion of it extracorporeally with an oxidative stressor, and reintroducing it into the same patient. The result, after one or more of such treatments, is a significant alleviation of the patient's CLL condition, as indicated in a reduced white blood cell proliferation and a reduced swelling of lymph nodes of the patient.

Thus from one aspect, the present invention provides a process for treating a CLL suffering patient for alleviation of CLL, which comprises extracting an aliquot of blood containing CLL cells from the patient, subjecting at least a portion of the extracted blood cells extracorporeally to appropriate oxidative stress, and re-introducing the oxidatively-stressed material into the patient.

Another aspect of the present invention is oxidatively stressed mammalian CLL cells, useful for introduction into a mammalian patient suffering from CLL to alleviate the patient's CLL.

A further aspect of the present invention is the use in preparation of a medicament active against CLL in a mammalian patient, of oxidatively stressed autologous blood or blood fractions, including oxidatively stressed autologous malignant CLL cells.

Another aspect of this invention is a composition comprising stressed CLL cells. The cells may be oxidatively stressed and may further be autologous CLL cells.

While it is not intended that this invention should be limited to any particular mode of action or theory of mechanism or performance, it is postulated that appropriately oxidatively stressed blood cells activate the regulatory immune T cells controlling the CD5+B cells in the patient's blood, including the malignant CD5+B cells. The oxidatively stressed cells, on reintroduction into the CLL patient, are believed to activate certain T cells present in the patient's blood which then down-regulate the malignant CD5+B cells by acting directly on them or by secreting cytokines which then act on them. In any event, the result is a significant reduction in the rate of proliferation of the malignant CD5+B cells in the CLL patient and a consequent alleviation of the CLL condition and its symptoms.



# Inhibiting the aggregation of blood platelets

## BACKGROUND OF THE INVENTION

### 1. Field of the Invention

The present invention relates to a method of inhibiting blood platelet aggregation in humans, as well as to a method of therapeutically treating human disease conditions associated with blood platelet aggregation. The invention also pertains to a method of stimulating the immune system, and to a method of therapeutically treating immune system disorders.

### 2. Description of the Prior Art

Platelets are the smallest of the formed elements of the blood. Every cubic millimeter of blood contains about 250 million platelets, as compared with only a few thousand white cells. There are about a trillion platelets in the blood of an average human adult. Platelets are not cells, but are fragments of the giant bone-marrow cells called megakaryocytes. When a megakaryocyte matures, its cytoplasm breaks up, forming several thousand platelets. Platelets lack DNA and have little ability to synthesize proteins. When released into the blood, they circulate and die in about ten days. However, platelets do possess an active metabolism to supply their energy needs.

Because platelets contain a generous amount of contractile protein (actomyosin), they are prone to contract much as muscles do. This phenomenon explains the shrinkage of a fresh blood clot after it stands for only a few minutes. The shrinkage plays a role in forming a hemostatic plug when a blood vessel is cut. The primary function of platelets is that of forming blood clots. When a wound occurs, platelets are attracted to the site where they activate a substance (thrombin) which starts the clotting process. Thrombin, in addition to converting fibrinogen into fibrin, also makes the platelets sticky. Thus, when exposed to collagen and thrombin, the platelets aggregate to form a plug in the hole of an injured blood vessel.

Platelets not only tend to stick to one another, but to the walls of blood vessels as well. Because they promote clotting, platelets have a key role in the formation of thrombi. The dangerous consequences of thrombi are evident in many cardiovascular and cerebrovascular disorders.

In this regard, the precise function of blood platelets in various human disease states has recently become increasingly understood as advances in biochemistry permit the etiologies of diseases to be better understood.

For example, many attempts have been made to explain the process of atherogenesis, that is, the creation of plaque which narrows arteries and, of particular concern, the coronary arteries. Recently, there has been increasing interest in the possible role of platelets in atherosclerosis.

In addition, a number of disease states in humans are believed to be associated with an aggregation of platelets in the blood. These platelet aggregation associated conditions include: peripheral vascular disease; thrombotic diseases such as coronary thrombosis and pulmonary thrombosis; stroke; eclampsia and pre-eclampsia; and hypertension.

A study completed by the University of Oxford, England, and published in the British Medical Journal, Vol. 296, Jan. 30 1988, pages 320-331, entitled "Secondary Prevention of Vascular Disease by Prolonged Antiplatelet Treatment," suggests that therapies which inhibit platelet aggregation may be useful for treating occlusive vascular disease. The study utilized aspirin, sulphinpyrazone, or aspirin and dipyridamole as the platelet aggregation inhibiting agents.

Unfortunately, long-term aspirin therapy may lead to severe gastrointestinal irritation and bleeding. Also, these and other known agents which inhibit platelet aggregation may have other undesirable side-effects that make them unsuitable for administration to patients who could benefit from such therapy. For pregnant women with pre-eclampsia or other platelet aggregation associated conditions, the administration of drugs may be undesirable in view of the potential effects of the same on the developing fetus.

## **TREATMENT OF AUTOIMMUNE DISEASES**

March 20, 2001 6,204,058 B1, Nov. 9, 1999 5,980,954 & Same as WO 98/07436

### **BACKGROUND OF THE INVENTION**

Autoimmune diseases include rheumatoid arthritis, graft versus host disease, systemic lupus erythematosus (SLE), scleroderma, multiple sclerosis, diabetes, organ rejection, inflammatory bowel disease, psoriasis, and other afflictions. It is becoming increasingly apparent that many vascular disorders, including atherosclerotic forms of such disorders, have an autoimmune component, and a number of patients with vascular disease have circulating auto antibodies.

Autoimmune diseases may be divided into two general types, namely systemic autoimmune diseases (exemplified by arthritis, lupus and scleroderma), and organ specific (exemplified by multiple sclerosis, diabetes and atherosclerosis, in which latter case the vasculature is regarded as a specific organ). In general terms, a normally functioning immune system distinguishes between the antigens of foreign invading organisms (non-self) and tissues native to its own body (self), so as to provide a defense against foreign organisms. Central to the proper functioning of the immune system, therefore, is the ability of the system to discriminate between self and non-self. When a patient's immune system fails to discriminate between self and non-self and starts to react against self antigens, then an autoimmune disorder may arise. The causes responsible for the reaction of an affected person's immune system against self are not fully understood, and several different theories have been put forward. The immune response to an antigen is triggered by the interaction of the antigen with receptors of predetermined specificity on certain lymphocytes. It is believed that, at an early stage in development of the immune system, those lymphocytes with receptors recognizing self antigens are recognized and eliminated from the body's system by a process of deletion.

Alternatively, or in addition, such self reactive lymphocytes may be controlled by the suppression of their activities. Both mechanisms probably occur. The immune system of normal healthy individuals is able to identify and to react against a family of proteins which are highly conserved in nature (ie they have a similar structure throughout all living organisms). This family of proteins is called the stress or heat-shock proteins (HSP), and they are grouped according to their approximate molecular Weights. Members of the HSP family include the HSP60 group, including, among others, proteins in the molecular weight range 50 to 100 kilodaltons.

Increased production of HSP's was first identified as a response to heat stress, but this now appears to be part of a general response to a variety of cell stresses. HSPs are normally located within cells, and function appears to be the stabilization of the structure of various proteins in stressed cells, so as to protect the cell from the protein denaturing effects of various stressors. However, it is likely that HSPs have a number of other functions which are, as yet, not fully understood. Heat shock proteins, HSP's, are



discussed in some detail by William J. Welch, in an article in "Scientific American", May, 1993, page 56.

One group of the family of HSP's, the HSP 60 group, contains proteins which show about 50% identity between bacterial cells and human cells. Infection With bacteria containing HSP 65 results in an immune response in healthy humans against the bacterial HSP65, evidenced by the production of anti-HSP65 antibodies. Thus, a healthy immune system appears to be able to identify and react against self-like antigens. In certain pathologies, for example many autoimmune diseases such as rheumatoid arthritis and scleroderma, patients also show the presence of antibodies to HSP 65. In the past, this has led to conclusions that autoimmune diseases result from bacterial infection. Now it seems likely that autoimmune diseases are associated with an inappropriate control of the autoimmune response. In other words, it is possible that the antibodies to HSP 65 result from an autoimmune reaction initiated by HSPs from the body itself, but one which has been improperly controlled. In such cases, therefore, it should be possible to control an inappropriate autoimmune response, by stimulating the body's natural immune control mechanisms, using a particular and specific method of vaccination.

To stimulate the body's immune response, a vaccine is required which will, upon injection into the host body, enable the host immune system to present the antigens contained in the vaccine to cells of the host immune system. Antigen presentation is performed by antigen presenting cells.

A vaccine to treat autoimmune diseases should contain antigens or fragments thereof (peptides) that will activate the body's immune control mechanisms present. In addition, the antigens (peptides) should be present in a form which can be recognized by the host immune system when the vaccine is introduced into the host. Certain of the antigens may be present on intact cells. The objective of such a vaccination is to activate regulatory immune pathways, particularly those controlling autoimmune responses, thereby down regulating the autoimmune response. The particular antigens which will activate the control mechanisms of a mammalian autoimmune system are not fully understood. It is however recognized that they may include antigens derived from lymphocyte receptors, which may function to stimulate control mechanisms, to inhibit those lymphocytes which cause pathological autoimmune responses in the patient. They may also include HSPs, such as the HSP 60 group of proteins, and leucocyte surface molecules such as those of the Major Histocompatibility Complex (MHC) including MHC Class II molecules. MHC Class II molecules function physiologically to present peptides to CD4+ T-cells as part of the immune response.

It is important that the lymphocyte receptors and other cell-derived molecules for vaccination of an auto-immune suffering patient be derived from cells obtained from the same patient, since this system will contain the autoimmune specificity. Receptors on other leucocytes in the blood may alternatively or additionally be important in a proposed vaccination process. The use of such a system as the basis of a vaccine may be considered analogous to the use of a particular viral antigen as a vaccine to treat and prevent disease caused by that virus. A vaccine for treating an autoimmune disease

should, therefore, be prepared from a sample of the patient's own blood. Such a vaccine may be described as an autovaccine. For antigens to be effective in stimulating (or inhibiting) the immune system, the antigens should be presented to immune cells of the host system by antigen-presenting cells, which are naturally present in the body. Many of the antigen-presenting cells are phagocytes, which attach to the antigens, engulf them by phagocytosis, and break them down or process them. The preparation of such an autovaccine should include a process whereby the lymphocytes and other leucocytes in the vaccine, which may be a source of antigens, are modified into a form whereby they are likely to be phagocytosed by phagocytic antigen-presenting cells upon re-injection into the patient, so that the antigens or effective residues thereof are presented on the surface of an antigen-presenting cell. Then they can effect a controlling mechanism on the immune system, either inhibitory or stimulatory. During the normal growth period of a mammalian body, tissues become reshaped with areas of cells being removed. This is accomplished by the cells' undergoing a process called programmed cell death or apoptosis, the apoptotic cells disintegrating and being phagocytosed while not becoming disrupted.

# Nitric Oxide and Platelet Aggregation

Nov. 10, 1998 US5834030 A

## BACKGROUND OF THE INVENTION

### 1. Field of the Invention

This invention relates to methods of increasing the concentration of nitric oxide in human blood, and to methods of therapeutically treating human disease conditions associated with reduced in vivo blood levels of nitric oxide.

### 2. Description of the Prior Art

Platelets are the smallest of the formed elements of the blood. Every cubic millimeter of blood contains about 250 million platelets, as compared with only a few thousand white cells. There are about a trillion platelets in the blood of an average human adult. Platelets are not cells, but are fragments of the giant bone-marrow cells called megakaryocytes. When a megakaryocyte matures, its cytoplasm breaks up, forming several thousand platelets. Platelets lack DNA and have little ability to synthesize proteins. When released into the blood, they circulate and die in about 10 days. However, platelets do possess an active metabolism to supply their energy needs.

Because platelets contain a generous amount of contractile protein (actomyosin), they are prone to contract much as muscles do. This phenomenon explains the shrinkage of a fresh blood clot after it stands for only a few minutes. The shrinkage plays a role in forming a hemostatic plug when a blood vessel is cut. The primary function of platelets is that of forming blood clots. When a wound occurs, platelets are attracted to the site where they activate a substance (thrombin) which starts the clotting process. Thrombin, in addition to converting fibrinogen into fibrin, also makes the platelets sticky. Thus, when exposed to collagen and thrombin, the platelets aggregate to form a plug in the hole of an injured blood vessel.

Platelets not only tend to stick to one another, but to the walls of blood vessels as well. Because they promote clotting, platelets have a key role in the formation of thrombi. The dangerous consequences of thrombi are evident in many cardiovascular and cerebrovascular disorders.

The precise function of blood platelets in various human disease states has recently become increasingly understood as advances in biochemistry permit the etiologies of diseases to be better understood.

For example, many attempts have been made to explain the process of atherogenesis, that is, the creation of plaque which narrows arteries and, of particular concern, the coronary arteries. Recently, there has been increasing interest in the possible role of platelets in atherosclerosis.

In this regard, there is a growing body of evidence that nitric oxide (NO) in the blood exercises various biochemical functions. As the precise biological role of nitric oxide has been explored, it has become known that nitric oxide serves as an important messenger molecule in the brain and other parts of the body, governing diverse biological functions. In blood vessels, the principal endothelium-derived relaxing factor (EDRF) is believed to be nitric oxide, which stimulates vasodilation. Nitric oxide also inhibits platelet aggregation and is partially responsible for the cytotoxic actions of macrophages.

In the brain, nitric oxide mediates the actions of the excitatory neurotransmitter glutamate in stimulating cyclic GMP concentrations. Immunohistochemical studies have localized nitric oxide synthase (NOS) to particular neuronal populations in the brain and periphery. Inhibitors of nitric oxide synthase block physiological relaxation of the intestine induced by neuronal stimulation, indicating that nitric oxide has the properties of a neurotransmitter. In this regard, nitric oxide appears to be a novel type of neuronal messenger, in that, unlike conventional neurotransmitters, nitric oxide is not stored in synaptic vesicles and does not act on typical receptor proteins of synaptic membranes. One function of nitric oxide may be to protect neurons from ischemic and neurotoxic insults. See, Bredt et al., "Cloned and Expressed Nitric Oxide Synthase Structurally Resembles Cytochrome P-450 Reductase," *Nature*, Vol. 351, June, 1991, pages 714-718.

Thus, in addition to platelet aggregation associated diseases, a number of other disease states in humans are presently believed to be associated with inadequate nitric oxide levels in the blood. These nitric oxide associated conditions include: high blood pressure, neurological conditions such as depression, tumors, bacterial and fungal infections, and impotence.

It would therefore be desirable to provide a method for increasing the nitric oxide concentration in human blood, in order to treat the above-described human disease states which are characterized by nitric oxide deficiency.

# Chronic post-traumatic pain syndromes

Complex regional pain syndrome (CRPS) may apply here

Jul 11, 2000 US6086552 A

## BACKGROUND OF THE INVENTION

Reflex sympathetic dystrophy (RSD) is a pathogenic condition affecting a patient's extremities and characterized by persistent pain and swelling with vasomotor and sudomotor changes, and later atrophy. The precipitating cause of RSD is soft tissue injury. Fractures of the bones of the wrists are commonly associated with RSD. Chronic undiagnosed knee pain, with few clinical signs beyond hyperaesthesia and limited movement may suggest RSD. It may only manifest itself days, weeks, or even years after the soft tissue injury has been incurred.

Adopting clinical criteria, the following operational definition of RSD was adopted at the Sixth World congress of Pain:

"RSD is a descriptive term meaning a complex disorder or group of disorders that may develop as a consequence of trauma affecting the limbs, with or without an obvious nerve lesion. RSD may also develop after visceral diseases, and central nervous system lesions or, rarely, without an obvious antecedent event. It consists of pain and related sensory abnormalities in the motor system and changes in structure of both superficial and deep tissues ("trophic changes"). It is not necessary that all components are present. It is agreed that the name "reflex sympathetic dystrophy" is used in a descriptive sense and does not imply specific underlying mechanisms".

The pathogenesis and pathophysiology of reflex sympathetic dystrophy are most commonly characterized by impaired vasomotor control which usually results in vasodilation and increased skin temperature over the affected area, in the initial stages, and vasoconstriction and reduced skin temperature in the later stages. Also, the blood flow and skin temperature changes in the contralateral limb following cold stress of the affected limb are abnormal, thus suggesting a central nervous system abnormality.

There is currently no specific, accepted treatment for RSD, and cure of it cannot be assured. Vascular and perhaps neurological changes occur during the natural history of the disease. Some treatments are directed to those. For example, calcitonin, a vasoconstrictor, is often used during the early vasodilation stage, but is inappropriate at later stages when vasoconstriction predominates. In this stage, pharmacologic or surgical sympathectomy is effective in some cases. Immobilization of the affected limb is avoided, since this exacerbates the problem. Alternative therapies include corticosteroids, transcutaneous nerve stimulation, acupuncture and autogenic training.

## REFERENCE TO THE PRIOR ART

A review of reflex sympathetic dystrophy by Dr. E. D. Cooke, Thermographic and Blood Flow Unit, St. Bartholomew's Hospital, London, U.K., appears in "Vascular Medicine Review", 1994; 5: 319-330.

in comparison with normal blood of the patient from whom it was extracted, of at least one of the following characterizing features:

increased numbers of lymphocytes and other leucocytes, exhibiting a condensed apoptotic-like morphology;

a release of specific proteins from the cell surface of the blood leucocytes, including the MHC Class II molecule HLA-DR, resulting in a reduction in the number of cells expressing such surface proteins;

an upregulation in the expression of certain cell surface markers for example CD-11b, a component of the ligand for the cell adhesion molecule ICAM-1;

a decrease in the amount of heat shock protein HSP-60 contained in the leucocytes, particularly the lymphocytes, therein, and an increase in HSP-60 in the plasma;

a decrease in HSP-72 within the lymphocytes;

a decrease in proliferation of treated mononuclear cells following mitogenic stimulation.

## DESCRIPTION OF THE PREFERRED EMBODIMENTS

By inducing an apoptotic-like state in the lymphocytes and other leucocytes in the blood comprising the aliquot, as evidenced by the increased numbers of lymphocytes and other leucocytes exhibiting a condensed apoptotic-like morphology therein, these cells may become preferentially phagocytosed upon re-injection into the host body.

There are a number of different phagocytic cell types present in the mammalian body, including various antigen presenting cells and neutrophils. In order to facilitate phagocytosis by antigen presenting cells rather than by other phagocytes, the lymphocytes and other leucocytes present in the aliquot of the invention are treated so that they may interact preferentially with antigen presenting phagocytic cells. Cells adhere to each other by a number of mechanisms including the expression of cell adhesion molecules. Cell adhesion molecules present on one cell type interact with specific ligands for particular adhesion molecules present on the adhering cell type. The present invention may result in a preferential interaction of cells in the treated aliquot to antigen presenting cells in the host body, by upregulation, on the surface of the cells in the treated aliquot of the expression of the ligand for adhesion molecules found on antigen-presenting cells in the host body. Antigen presenting cells express a number of cell adhesion molecules, including ICAM-1, a component of the ligand of which is CD-11b. One way by which the

process of the invention may change the preferential phagocytosis of apoptosing cells is by upregulation of CD-11b.

## TREATMENT OF STRESS AND PRECONDITIONING AGAINST STRESS

Oct 24, 2000 6,136,308

### BACKGROUND AND PRIOR ART

The effects of stress on a mammal normally manifest themselves in an increase in body temperature, along with a change in hemodynamic parameters, including an increase in heart rate and an increase in blood pressure. For patients already suffering from elevated blood pressure (hypertension, the effects of stress can therefore be particularly dangerous, since hypertension is a major risk factor for cardiovascular disease.

Stresses to which a mammal may be subjected, and which can result in these effects, can take a wide variety of physical forms. Psychological stresses induced by restraint, confinement, sudden exposure to danger, shock and the like translate into physical stresses affecting one or more organs of the body. Similarly, physical stress such as exposure to heat or cold, injury including surgical injury, over-exertion and the like, result in abnormal functioning of body organs. Stress is now recognized as a major detrimental factor in many diseases such as cardiovascular disease, cancer, and immunological dysfunction. Common physiological events which appear to underlie all stress responses include the induction and upregulation of synthesis, in all body cells, of a group of specialized intracellular proteins known as heat stress proteins or heat shock proteins (HSP's). These HSP's function to protect the cells from potential damage caused by whatever form of stress is being applied.

One particular species of physical stress is ischemia, which is the deprivation of oxygen resulting from reduced blood flow. Ischemia in a body organ, if severe enough, causes the eventual death of cells in the organ. Re-perfusion of the ischemic organ by resumption of blood flow thereto often results in further injury to the organ due to inflammation, and does not invigorate already injured cells. Repeated application of mild ischemic stress to an organ often leads to an increased ability to withstand stress ischemia, an effect thought to be partially related to upregulated synthesis of HSPs. Ischemia may occur as a pathological condition, e.g. as the result of spasm, thrombosis, or other blood vessel obstruction. Ischemia may be deliberately induced by clamping of blood vessels during surgery.

It is known to precondition the body of a mammalian patient by subjecting it to controlled stresses, so as better to equip the body for subsequent encounters with uncontrolled stresses of the same type. Physical exercise and training, for example, equips a body for better handling of physical exertion stresses. Heating a body or a body organ repeatedly under controlled conditions has been shown to provide the body or body organ with preconditioning for the better handling of subsequent heat stresses. Even in respect of ischemia, a body organ such as the heart which has previously suffered mild ischemia is better able to resist the effects of later ischemia, of the type causing myocardial infarction. As stated by Gersh et al., "Preconditioning is an important phenomenon, probably with clinical implications, because repetitive



anginal episodes in patients may develop into full fledged infarction. Patients with pre-infarction angina may suffer from a less severe infarct than those thought to undergo sudden coronary occlusion without the opportunity for preconditioning. In contrast, patients with multiple short-lived attacks of ischemia might become tolerant through the development of protective preconditioning, according to animal data.”<sup>1</sup> Preconditioning by subsection to heat or ischemia is however clearly impractical in respect of most mammalian bodies and body organs.

**Ischemia**, also spelled as **ischaemia** or **ischæmia** is a restriction in blood supply to [tissues](#), causing a shortage of [oxygen](#) and [glucose](#) needed for [cellular metabolism](#) (to keep tissue alive).

Infarction is tissue death (necrosis) caused by a local lack of oxygen, due to an obstruction of the tissue's blood supply

## **Method for preventing and reversing atherosclerosis in mammals**

Jul 24, 2001 **US 6264646 B1**

### **BACKGROUND OF THE INVENTION**

Hyperlipidemias such as hypercholesterolemia and elevated serum triglyceride levels are among the most potent risk factors in the causation of atherosclerosis, which is the build-up of fatty plaque deposits within the walls of blood vessels. For example, high levels of serum cholesterol bound to low density lipoprotein (LDL), intermediate density lipoprotein (IDL) or very low density lipoprotein (VLDL) are known to correlate strongly with the occurrence of atherosclerosis in humans. In particular, it is believed that the higher the circulating levels of cholesterol in the form of LDL, IDL and VLDL cholesterol, and the higher the circulating levels of other lipids such as triglycerides, the more likely it is that cholesterol and lipids will be deposited within the blood vessel wall and cause or contribute to atherosclerosis.

In hypercholesterolemia, for example, the increase in the blood cholesterol level is associated mainly with a rise in the concentration of LDL, IDL and VLDL cholesterol. However, the specific causes of hypercholesterolemia are complicated and varied. At least one kind of hypercholesterolemia, known as familial hypercholesterolemia, is caused by a mutation in the gene for the LDL receptor that moves cholesterol out of the blood, primarily in the liver. Much more commonly, hypercholesterolemia has been associated with high dietary intake of saturated fatty acids and cholesterol, resulting in elevated blood cholesterol levels. High serum triglyceride levels have also been associated with high dietary intake of fatty acids.

Reduction of hyperlipidemia, including hypercholesterolemia, results in a delayed onset of atherosclerosis and a decrease in the progression of atherosclerosis, thus reducing the risk of coronary heart disease. In addition, there is evidence that relatively complicated plaques induced by hyperlipidemia can regress, and that further progression of atherosclerosis will decrease or cease when hyperlipidemia is removed. Some forms of hyperlipidemia, including hypercholesterolemia, are potentially partially reversible with current techniques of preventive management. Taking cholesterol-lowering drugs can result in a reduction in serum cholesterol, and other drugs may lower serum triglyceride levels. However, drugs are not always warranted for hyperlipidemia, and some lipid-lowering drugs may have serious side effects. Dietary therapy is usually recommended for all patients with hyperlipidemia but the effect is often not sufficient to reduce risk optimally.

Therefore, there is a need for a method which is effective in lowering blood lipid levels, especially cholesterol and triglyceride levels, and which does not have significant side effects.

### **SUMMARY OF THE INVENTION**

The present invention overcomes at least some of the above-noted and other disadvantages of presently known therapies for treatment of hyperlipidemia, such as hypercholesterolemia and elevated serum triglyceride levels, by providing a method for treating hyperlipidemia in which an aliquot of mammalian blood is treated *ex vivo* and subsequently introduced into the body of a mammalian subject.

The aliquot of blood is treated by being subjected to one or more stressors which have been found to modify the blood. According to the present invention, the blood aliquot can be modified by subjecting the blood, or separated cellular or non-cellular fractions of the blood, or mixtures of the separated cells and/or non-cellular fractions of the blood, to stressors selected from heat, ultraviolet light and oxidative environments such as treatment with ozone/oxygen mixtures, or any combination of such stressors, simultaneously or sequentially.

The observed effects of the modified blood of the present invention, when introduced into the mammalian subject's body, are several in number. Firstly, there is an observed reduction in total serum cholesterol levels, primarily due to a reduction in the levels of LDL and VLDL cholesterol. Levels of beneficial HDL cholesterol are not reduced. Reductions in cholesterol levels of as high as about 40 percent, as compared to subjects which received untreated blood as a placebo, have been observed. Secondly, there is an observed reduction in serum triglyceride levels. Such reductions in serum cholesterol and triglycerides would be expected to delay the onset and retard the progression of atherosclerosis due to hyperlipidemia.

Another of the observed effects of the treatment according to the present invention is that mammalian subjects treated according to the present invention show substantially reduced deposition of lipids within blood vessel walls, as compared to untreated subjects. As well as retarding the progression of plaque deposition, the treatment of the invention has been shown to cause existing plaques to regress. It is believed that this observed vessel protection is due at least in part to the reduced serum lipid levels in subjects treated by the method of the present invention. However, the reduced deposition of lipids within blood vessel walls has also been observed in the absence of a reduction in serum lipids.

## GVHD and Bone marrow transplant

Jul 10, 2001 US 6258357 B1

### BACKGROUND OF THE INVENTION

Bone marrow transplantation, BMT, is indicated following a process which destroys bone marrow. For example, following intensive systemic radiation or chemotherapy, bone marrow is the first target to fail. Metastatic cancers are commonly treated with very intensive chemotherapy, which is intended to destroy the cancer, but also effectively destroys the bone marrow. This induces a need for BMT. Leukemia is a bone marrow malignancy, which is often treated with BMT after chemotherapy and/or radiation has been utilized to eradicate malignant cells. BMT is currently used for treatment of leukemias which are life-threatening. Some autoimmune diseases may be severe enough to require obliteration of their native immune systems which includes concomitant bone marrow obliteration and requires subsequent bone marrow transplantation. Alleviation of any but the most acute life-threatening conditions involving bone marrow disorders with BMT is, however, generally regarded as too risky, because of the likelihood of the onset of graft versus host disease.

Graft-versus-host disease, GVHD, is an immunological disorder that is the major factor that limits the success and availability of allogeneic bone marrow or stem cell transplantation (collective referred to herein as allo-BMT) for treating some forms of otherwise incurable hematological malignancies, such as leukemia. GVHD is a systemic inflammatory reaction which causes chronic illness and may lead to death of the host mammal. At present, allogeneic transplants invariably run a severe risk of associated GVHD, even where the donor has a high degree of histocompatibility with the host.

GVHD is caused by donor T-cells reacting against systemically distributed incompatible host antigens, causing powerful inflammation. In GVHD, mature donor T-cells that recognize differences between donor and host become systemically activated. Current methods to prevent and treat GVHD involve administration of drugs such as cyclosporin-A and corticosteroids. These have serious side effects, must be given for prolonged periods of time, and are expensive to administer and to monitor. Attempts have also been made to use T-cell depletion to prevent GVHD, but this requires sophisticated and expensive facilities and expertise. Too great a degree of T-cell depletion leads to serious problems of failure of engraftment of bone marrow stem cells, failure of hematopoietic reconstitution, infections, or relapse. More limited T-cell depletion leaves behind cells that are still competent to initiate GVHD. As a result, current methods of treating GVHD are only successful in limited donor and host combinations, so that many patients cannot be offered potentially life-saving treatment.

## SUMMARY OF THE INVENTION

According to the present invention, a patient being treated by allo-BMT is administered a composition containing T-cells obtained from an allogeneic donor, said T-cells having been subjected in vitro to oxidative stress to induce therein decreased inflammatory cytokine production coupled with reduced proliferative response. It appears that such oxidatively stressed allogeneic T-cells when injected into a mammalian patient, have a down-regulated immune response and a down-regulated destructive allogeneic response against the recipient, so that engraftment of the hematopoietic stem cells, administered along with or separately from the stressed T-cells, can take effect with significantly reduced risk of development of GVHD. The population of stressed T-cells nevertheless appears to be able to exert a sufficient protective effect on the mammalian system to guard against failure of engraftment and against infection, whilst the hematopoietic system is undergoing reconstitution, at least in part, by proliferation and differentiation of the allogeneic stem cells.

One aspect of the present invention provides, accordingly, a process of treating a mammalian patient for alleviation of a bone marrow mediated disease, with alleviation of consequently developed graft versus host disease (GVHD), which comprises administering to the patient allogeneic hematopoietic stem cells and allogeneic T-cells, at least a portion of said T-cells having been subjected to oxidative stress in vitro, prior to administration to the patient, so as to induce an altered cytokine production profile and a reduced proliferative response therein.

Another aspect of the present invention provides a population of mammalian T-cells, essentially free of stem cells, said T-cells having been subjected in vitro to oxidative stress so as to induce in said cells an altered cytokine production profile and a reduced proliferative response.

A further aspect of the present invention provides a process for preparing an allogeneic cell population for administration to a human patient suffering from a bone marrow mediated disease, which comprises subjecting, in vitro, a population of donor cells enriched in T-cells to oxidative stress to induce in said T-cells an altered cytokine production profile and a reduced proliferative response.

# Treatment of cardiovascular diseases with ozone

Dec 16, 2010 US 20100316730 A1

## BACKGROUND OF THE INVENTION

Note: The methods of the present invention employ an ozone-delivery system for delivering and manufacturing a measured amount of an ozone/oxygen admixture, which is able to measure, control and report, and differentiate between, delivered-ozone and the absorbed-dose of ozone.

**Treating:** Diseases targeted as potential candidates for treatment by the methods disclosed in the present invention include atherosclerosis, peripheral arterial occlusive disease, cerebrovascular accident, angina pectoris and vasospastic disorders, such as Raynaud's disease, dyslipidemia, congestive heart failure and hypertension.

**Action:** The methods of the present invention are directed to treating blood with ozone extracorporeally to generate leukocyte apoptosis, without excessive necrosis, sufficient to reduce edema, improve impaired blood flow, reduce atherosclerotic plaques, cause regression in atherosclerotic plaque formation, relax the vascular endothelium, reduce inflammation and reduce lipids and lipid deposits once the treated blood is reinfused.

### 1. Field of the Invention

This invention relates to therapeutic treatments for cardiovascular diseases including atherosclerosis, peripheral arterial occlusive disease, congestive heart failure, hypertension, cerebrovascular disease, dyslipidemia, and vasospastic disorders, including Raynaud's disease, in a mammalian patient, and specifically relates to therapeutic treatment of cardiovascular disorders or conditions using quantifiable absorbed doses of ozone delivered to a biological fluid by an ozone delivery system.

### 2. Statement of the Relevant Art

The references discussed herein are provided solely for the purpose of describing the field relating to the invention. Nothing herein is to be construed as an admission that the inventors are not entitled to antedate a disclosure by virtue of prior invention. Furthermore, citation of any document herein is not an admission that the document is prior art, or considered material to patentability of any claim herein, and any statement regarding the content or date of any document is based on the information available to the applicant at the time of filing and does not constitute an affirmation or admission that the statement is correct.

Cardiovascular diseases are responsible for a significant number of deaths in most industrialized countries. One such disease is atherosclerosis, a disease of large and medium-sized muscular arteries and is characterized by endothelial dysfunction, vascular inflammation, and the buildup of lipids, cholesterol, calcium, and cellular debris within the intima of the vessel wall. This buildup results in plaque formation, vascular remodeling, acute and chronic luminal obstruction and abnormalities of blood flow, and also results in ischemia (diminished oxygen supply to organs and tissues) of target organs such as the heart, brain and other vital organs. Prolonged or sudden ischemia may result in a clinical heart attack or stroke from which the patient may or may not recover.

The true frequency of atherosclerosis is difficult, if not impossible, to accurately determine because it is predominantly an asymptomatic condition. The process of atherosclerosis begins in childhood with the development of fatty streaks and advances with increasingly more complicated lesion formation throughout adult life.

In the United States, approximately 7.8 million myocardial infarctions occur annually, and more than 13.2 million Americans have chronic coronary artery disease. Of persons older than 50 years, 30% have some evidence of carotid artery disease, and cerebrovascular disease is responsible for over 160,000 deaths per year in the United States. More than 50 million people in the United States are candidates for some form of dietary and/or drug treatment to modify their lipid profile.

**Pathophysiology:** A complex and incompletely understood interaction exists between the critical cellular elements of the atherosclerotic lesion. These cellular elements include endothelial cells, smooth muscle cells, platelets, and leucocytes. Vasomotor function, the thrombogenicity of the blood vessel wall, the state of activation of the coagulation cascade, the fibrinolytic system, smooth muscle cell migration and proliferation, and cellular inflammation are complex and interrelated biological processes that contribute to atherogenesis and the clinical manifestations of atherosclerosis.

The mechanisms of atherogenesis remain uncertain. It is presently believed that early events include endothelial injury, which cause vascular inflammation and a fibroproliferative response ensues.

The earliest pathologic lesion of atherosclerosis is the fatty streak and is observed in the aorta and coronary arteries of most individuals by age 20 years. The fatty streak is the result of localized accumulation of serum lipoproteins within the intima of the vessel wall. The fatty streak may progress to form a fibrous plaque, and is the result of progressive lipid accumulation and the migration and proliferation of smooth muscle cells. Activators of cell-division are produced by activated platelets, macrophages and dysfunctional endothelial cells that characterize early atherogenesis, vascular inflammation, and platelet-rich thrombosis at sites of endothelial disruption.

Vascular inflammation, believed to be a significant component in the etiology of atherosclerosis, may be due to an imbalance between pro-inflammatory (e.g. interferon-gamma, TNF-gamma, IL-6, IL-8 and IL-12) and anti-inflammatory cytokine (e.g. interleukin-4 and IL-10) release by immunomodulatory T cells

associated with an atherosclerotic lesion. Similar imbalances have been implicated in other autoimmune diseases such as psoriasis, rheumatoid arthritis, scleroderma, lupus, diabetes mellitus, organ rejection, miscarriage, multiple sclerosis, inflammatory bowel disease as well as graft versus host disease.

There is also an emerging body of literature which indicates that the vascular endothelium plays a major role in the regulation of blood flow through the cardiovascular system and is of importance in connection with cardiovascular disorders. A dysfunctional endothelium has been suggested as a contributory factor in many cardiovascular diseases such as atherosclerosis, peripheral arterial occlusive disease and many other circulatory disorders observed in mammalian patients. Recent evidence indicates that a relative deficiency in endothelium-derived nitric oxide, a vasodilator, further potentiates the proliferative stage of plaque maturation.

Growth of the fibrous plaque results in vascular remodeling, progressive luminal narrowing, blood-flow abnormalities, and compromised oxygen supply to target organs. Human coronary arteries enlarge in response to plaque formation, and luminal stenosis may only occur once the plaque occupies greater than 40% of the area bounded by the internal elastic lamina.

The stripping or removal (i.e. denudation) of the overlying endothelium or rupture of the protective fibrous cap may result in exposure of the thrombogenic contents of the core of the plaque to the circulating blood. A plaque rupture may result in thrombus formation, partial or complete occlusion of the blood vessel, and progression of the atherosclerotic lesion due to organization of the thrombus and incorporation within the plaque.

**Physical Symptoms and Clinical Events of Atherosclerosis:** The physical symptoms of atherosclerosis provide objective evidence of extracellular lipid deposition, stenosis or dilatation of large muscular arteries, or target organ ischemia or infarction, and include the physical symptoms discussed hereinafter.

**Intermittent claudication:** Claudication, which is defined as reproducible ischemic muscle pain, is one of the most common manifestations of peripheral arterial occlusive disease caused by atherosclerosis. Claudication occurs during physical activity and is relieved after a short rest. Calf, thigh or buttock pain develops because of inadequate blood flow. The most feared consequence of claudication is severe limb-threatening ischemia leading to amputation. However, studies of large patient groups with claudication reveal that amputation is uncommon. Intermittent claudication may be accompanied by pallor of the extremity and paresthesias (abnormal sensation, such as tingling or burning of touch without stimulus).

Intermittent claudication typically causes pain that occurs with physical activity. Determining how much physical activity is needed before the onset of pain is crucial. Typically, vascular surgeons relate the onset of pain to a particular walking distance in terms of street blocks (e.g. two-block claudication). This helps to quantify patients with some standard measure of walking distance before and after therapy. Other important aspects of claudication pain are that the pain is reproducible within the same muscle



groups and that it ceases with a resting period of 2-5 minutes. Location of the pain is determined by the anatomical location of the arterial lesions.

Additional muscular symptomology; Reduced blood flow that may be caused by either cholesterol embolism or arterial stenosis is frequently associated with muscular symptomology in an extremity or muscle group distal to the embolism or vascular constriction. Numbness and tingling, muscular spasm, weakness and loss of movement are common reportable events.

Extremity temperature: Reduced flow of blood resulting in oxygen deprivation to an organ or tissue (ischemia) is commonly associated with both atheroembolism (cholesterol embolism) and arterial stenosis. This is frequently associated with a measurable decrease the temperature of an extremity distal to the site of the embolism or vascular narrowing.

Decreased pulse: A decrease or loss of pulse due to reduced blood flow in instances of atheroembolism and arterial stenosis is a quantifiable parameter and frequently associated with loss of pallor in an extremity.

Hypertension secondary to arterial stenosis: The primary factor in hypertension is an increase in peripheral resistance resulting from vasoconstriction of peripheral blood vessels secondary to arterial stenosis.

Weight gain: A major factor underlying weight gain is lipid deposition secondary to the accumulation of excessive triglycerides or the inhibition in the clearance of triglycerides.

Clinical events relating to cardiovascular disease include progressive luminal narrowing of an artery due to expansion of a fibrous plaque, which results in impairment of flow when more than 50-70% of the lumen diameter is obstructed. This impairment in flow results in symptoms of inadequate blood supply to a target organ in the event there is an increase in metabolic activity and therefore oxygen demand. Stable angina pectoris, intermittent claudication, and mesenteric angina are examples of the clinical consequences of this condition.

Rupture of a plaque or denudation of the endothelium overlying a fibrous plaque may result in exposure of the highly thrombogenic subendothelium and lipid core. This exposure may result in thrombus formation, which may partially or completely occlude flow in the involved artery. Unstable angina pectoris, myocardial infarction, transient ischemic attack, and stroke are examples of the clinical manifestations of partial or complete acute occlusion of an artery.

Atheroembolism, also known as cholesterol embolism, refers to the occlusion of small- and medium-caliber arteries (100-200  $\mu\text{m}$  in diameter) by cholesterol crystals. It may present with symptoms of digital necrosis, hypertension, gastrointestinal bleeding, myocardial infarction, retinal ischemia, cerebral infarction, and renal failure. Physical signs include Livedo reticularis (a persistent purplish network-

patterned discoloration of the skin caused by dilation of capillaries and venules due to stasis or changes in underlying blood vessels), gangrene, cyanosis, and ulceration. The presence of pedal pulses in the setting of peripheral ischemia suggests microvascular disease.

Angina pectoris is characterized by retrosternal chest discomfort that typically radiates to the left arm and may be associated with dyspnea. Angina pectoris is exacerbated by exertion and relieved by rest or nitrate therapy. Unstable angina pectoris describes a pattern of increasing frequency or intensity of episodes of angina pectoris and includes pain at rest. A prolonged episode of angina pectoris that may be associated with diaphoresis is suggestive of myocardial infarction.

Cerebrovascular disease designates any abnormality of the brain resulting from a pathologic process of the blood vessels, e.g. occlusion of the lumen by a thrombus or embolus, rupture of a vessel, any lesion or altered permeability of the vessel wall and increased viscosity or other change in quality of blood. Disorders of the cerebral circulation include any disease of the vascular system that causes ischemia or infarction of the brain or spontaneous hemorrhage into the brain or subarachnoid space.

A cerebrovascular accident (CVA) or stroke is the sudden death of brain cells due to impaired blood flow resulting in abnormal brain function. Blood flow to the brain can be disrupted by either a blockage (clogging of arteries within the brain, carotid arterial occlusion or embolism) or rupture of an artery (cerebral hemorrhage or subarachnoid hemorrhage) to the brain.

A transient ischemic attack (TIA) is a short-lived episode (less than 24 hours) of temporary impairment of the brain that is caused by a loss of blood supply. A TIA causes a loss of function in the area of the body that is controlled by the portion of the brain affected.

Causative factors involved in cerebrovascular disease includes cerebral infarction and ischemia which is caused by sudden occlusion of an artery supplying the brain, or, less often, by low flow distal to an already occluded or highly stenosed artery. Occlusion or stenosis can be the result of disease of the arterial wall or embolism from the heart. Infarction originates as a result of an impediment to normal perfusion that usually is caused by atherosclerosis and coexisting thrombosis. Atheroembolism (atheroma) occurs when a particle of a thrombus originating from a proximal source (arterial, cardiac or transcatheter) travels through the vascular system and leads to a distal occlusion.

A corollary and additional factor in cerebrovascular disease is the incidence of intracranial small vessel disease (microatheroma). The small penetrating arteries of the brain are not supported by a good collateral circulation and occlusion of one of these arteries is rather likely to cause infarction, often in a small, restricted area of the brain.

Inflammatory vascular disease of the arterial (or venous) wall may provoke enough cellular proliferation, necrosis and fibrosis to occlude the lumen, precipitate thrombosis and then embolism, or promote aneurysm formation, dissection and even rupture of the vessel. These vasculitic disorders may present

with, or be complicated during their course by, ischemic stroke, intracranial hemorrhage, intracranial venous thrombosis and, most often, a generalized ischemic encephalopathy.

Physical signs of cerebrovascular disease include diminished carotid pulses, carotid artery bruits, and focal neurological deficits.

Peripheral arterial occlusive disease (PAOD) typically manifests as intermittent claudication, impotence, and non-healing ulceration and infection of the extremities. PAOD is most common with the distal superficial femoral artery (located just above the knee joint), which corresponds to claudication in the calf muscle area (the muscle group just distal to the arterial disease). When atherosclerosis is distributed throughout the aortoiliac area, thigh and buttock muscle claudication predominates.

Physical signs include decreased peripheral pulses, peripheral arterial bruits (an unexpected audible swishing sound or murmur heard over an artery or vascular channel which indicates increased turbulence often caused by a partial obstruction), pallor, peripheral cyanosis, gangrene, ulceration. Visceral ischemia may be occult or symptomatic prior to symptoms and signs of target organ failure.

Mesenteric angina is characterized by epigastric or periumbilical postprandial pain and may be associated with hematemesis, melena, diarrhea, nutritional deficiencies, and weight loss. Abdominal aortic aneurysm typically is asymptomatic prior to the dramatic and often fatal symptoms and signs of rupture, although patients may describe a pulsatile abdominal mass. Physical signs include pulsatile abdominal mass, peripheral embolism and circulatory collapse.

Dyslipidemia is a disorder of lipoprotein metabolism, including lipoprotein overproduction or deficiency. Dyslipidemias may be manifested by elevation of the total cholesterol, low-density lipoprotein (LDL) cholesterol and the triglyceride concentrations, and a decrease in the high-density lipoprotein (HDL) cholesterol concentration in the blood.

Congestive Heart Failure (CHF), most frequently resulting from coronary artery disease or hypertension, and occurs when the heart can no longer meet the metabolic demands of the body at normal physiologic venous pressures. As the demands on the heart outstrip the normal range of physiologic compensatory mechanisms, signs of CHF occur. These signs include tachycardia, venous congestion, high catecholamine levels and, ultimately, insufficient cardiac output. Chronic inflammation is recognized as an underlying pathology contributing to the development and progression of chronic heart failure.

Raynaud's disease refers to a disorder in which the fingers or toes (digits) suddenly experience decreased blood circulation. Raynaud's disease can be classified as either primary (or idiopathic) and secondary (also called Raynaud's phenomenon). Primary Raynaud's disease is milder, and causes fewer complications.

Secondary Raynaud's disease is more complicated, severe, and more likely to progress. A number of medical conditions predispose a person to secondary Raynaud's disease, including scleroderma, which is a serious disease of the connective tissue in which tissues of the skin, heart, esophagus, kidney and lung become thickened, hard and constricted. About 30% of patients who develop scleroderma will first develop Raynaud's disease. Other medical conditions predisposing a person to secondary Raynaud's disease include connective tissue diseases, such as systemic lupus erythematosus, rheumatoid arthritis, dermatomyositis and polymyositis, and diseases which result in blockages of arteries (i.e. atherosclerosis).

Both primary and secondary types of Raynaud's symptoms are believed to be due to over-reactive arterioles (small arteries). While cold normally causes the muscle which makes up the walls of arteries to contract, in Raynaud's disease the degree is extreme, and blood flow to the area is severely restricted.

The relationship between dietary lipid, serum cholesterol and atherosclerosis has long been recognized. In many epidemiological studies it has been shown that a single measurement of serum cholesterol has proved to be a significant predictor of the occurrence of coronary heart disease. Thus diet is the basic element of all therapy for hyperlipidemia (excessive amount of fat in plasma). However, the use of diet as a primary mode of therapy requires a major effort on the part of physicians, nutritionists, dietitians and other health professionals. If dietary modification is unsuccessful, drug therapy is an alternative. Several drugs, used singly or in combination, are available. However, there is no direct evidence that any cholesterol-lowering drug can be safely administered over an extended period.

A combination of both drug and diet may be required to reduce the concentration of plasma lipids. Hypolipidemic drugs are therefore used as a supplement to dietary control. Many drugs are effective in reducing blood lipids, but none work in all types of hyperlipidemia and they all have undesirable side effects. There is no conclusive evidence that hypolipidemic drugs can cause regression of atherosclerosis. Thus, despite progress in achieving the lowering of plasma cholesterol to prevent heart disease by diet, drug therapies, surgical revascularization procedures and angioplasty, atherosclerosis remains the major cause of death in Western countries.

In view of the above, new approaches are being sought to reduce the frequency of clinical sequelae secondary to the myriad of diseases and disorders broadly characterized as cardiovascular diseases.

## Apoptosis

Apoptosis specifically refers to an energy-dependent, asynchronous, genetically controlled process by which unnecessary or damaged single cells self-destruct when apoptosis genes are activated (Martin, S J 1993; Earnshaw, W C 1995). There are three distinct phases of apoptosis. Initially, the cell shrinks and detaches from neighboring cells. The nucleus is broken down with changes in DNA including strand breakage (karyorhexis) and condensation of nuclear chromatin (pyknosis). In the second phase, nuclear fragments and organelles condense and are ultimately packaged in membrane-bound vesicles,

exocytosed and ingested by surrounding cells. In the final phase, membrane integrity is finally lost and permeability to dyes (i.e. trypan blue) occurs. The absence of inflammation differentiates apoptosis from necrosis when phagocytized by macrophages and epithelial cells (Kam, PCA 2000).

In contrast, necrotic cell death is a pathological process caused by overwhelming noxious stimuli (Lennon, S V 1991). Synchronously occurring in multiple cells, it is characterized by cell swelling or "oncosis," resulting in cytoplasmic and nuclear swelling and an early loss of membrane integrity. Bleb formation (blister-like, fluid filled structures) of the plasma membrane occurs, in which ultimate rupture may occur causing an influx of neutrophils and macrophages in the surrounding tissue, and leading to generalized inflammation (Majno, G 1995).

Four main groups of stimuli for apoptosis have been reported; ionizing radiation and alkylating anticancer drugs causing DNA damage, receptor mechanism modulation (i.e. glucocorticoids, tumor necrosis factor- $\alpha$ , nerve growth factor or interleukin-3), enhancers of apoptotic pathways (i.e. phosphatases and kinase inhibitors), and agents that cause direct cell membrane damage and include heat, ultraviolet light and oxidizing agents (i.e. superoxide anions, hydroxyl radicals and hydrogen peroxide) (Kam, PCA 2000).

In addition to the oxidizing agents, many chemical and physical treatments capable of inducing apoptosis are also known to evoke oxidative stress (Buttke, M 1994, Chandra, J 2000). Ionizing and ultraviolet radiation both generate reactive oxygen intermediates (ROI) such as hydrogen peroxide and hydroxyl free radicals. Low doses of hydrogen peroxide (10-100  $\mu$ M) induces apoptosis in a number of cell types directly establishing oxidative stress as a mediator of apoptosis. However, high doses of this oxidant induce necrosis, consistent with the concept that the severity of the insult determines the form of cell death (apoptosis vs, necrosis) that occurs. A free radical is not a prerequisite for inducing apoptosis; doxorubicin, cisplatin and ether-linked lipids are anti-neoplastics that induce apoptosis and oxidative damage.

Alternatively, oxidative stress can be induced by decreasing the ability of a cell to scavenge or quench reactive oxygen intermediates (ROI) (Buttke, M 1994). Drugs (i.e. butathionine sulfoxamine) that reduce intracellular glutathione (GSH) render cells more susceptible to oxidative stress-induced apoptosis. Cell studies report a direct relationship between extracellular catalase levels and sensitivity to hydrogen peroxide-induced apoptosis. Apoptosis induced through tumor necrosis factor- $\alpha$  stimulation has been demonstrated to be associated with an increase in intracellular ROI. However, this apoptosis has been inhibited by the addition of a number of antioxidants, such as thioredoxin, a free radical scavenger, and N-acetylcysteine, an antioxidant and GSH precursor.

There is growing evidence that apoptotic neutrophils have an active role to play in the regulation and resolution of inflammation following phagocytosis by macrophages and dendritic cells. A hallmark of phagocytic removal of necrotic neutrophils by macrophages is an inflammatory response including the release of proinflammatory cytokines (Vignola, A M 1998, Beutler, B 1988, Moss, S T 2000, Fadok V A, 2001). In contrast, apoptotic neutrophil clearance is not accompanied by an inflammatory response;

phagocytosis of these apoptotic cells has been shown to inhibit macrophage production of pro-inflammatory cytokines (GM-CSF, IL-1 $\beta$ , IL-8, TNF- $\alpha$ , TxB<sub>2</sub>, and LTC<sub>4</sub>) with a concomitant activation of anti-inflammatory cytokine production (TGF- $\beta$ 1, PGE<sub>2</sub> and PAF) (Fadok, V A 1988, Cvetanovic, M 2004). This phenomenon of suppression of proinflammatory cytokine production by macrophages has been extended to include phagocytosis of apoptotic lymphocytes (Fadok, V A 2001).

In addition to macrophages, down regulation of pro-inflammatory cytokine release in response to apoptotic cells has also been demonstrated by non-phagocytizing cells including human fibroblasts, smooth muscle, vascular endothelial, neuronal and mammary epithelial cells (Fadok, V A 1988, 2000; McDonald, P P 1999, Cvetanovic M, 2006). Apoptotic neutrophils in contact with activated monocytes elicit an immunosuppressive cytokine response, with enhanced IL-10 and TGF- $\beta$  production and only minimal TNF- $\alpha$  and IL-1 $\beta$  cytokine production (Byrne, A 2002). Byrne et al. concluded that the interaction between activated monocytes and apoptotic neutrophils may create a unique response, which changes an activated monocyte from being a promoter of the inflammatory cascade into a cell primed to deactivate itself and other cellular targets.

Techniques to identify and quantify apoptosis, and distinguish this event from necrosis, may include staining with nuclear stains allowing visualization of nuclear chromatin clumping (i.e. Hoeschst 33258 and acridine orange) (Earnshaw, W C 1995). Accurate identification of apoptosis is achieved with methods that specifically target the characteristic DNA cleavages. Agarose gel electrophoresis of extracted DNA fragments yields a characteristic 'ladder' pattern which can be used as a marker for apoptosis (Bortner, C D 1995). A lesser extent of DNA degradation produces hexameric structures called 'rosettes' where necrotic cells leave a nondescript smear (Pritchard, D M 1996). Terminal transferase deoxyuridine nick-end labeling of DNA break points (TUNEL analysis), which labels uridine residues of the nuclear DNA fragments, can also be used to quantify apoptosis (Gavrieli, Y 1992).

Several signature events in the process of apoptosis may also be quantified by flow cytometry. These include dissipation of the mitochondrial membrane potential which is an early apoptotic event, externalization of phosphatidylserine through capture with annexin V, loss of plasma membrane integrity and nuclear chromatin condensation (distinguishing live, apoptotic and necrotic cells), and activation of caspase enzymes (early stage feature of apoptosis) (Technical Bulletin—InVitrogen 2004).

Vascular endothelial cells, including human umbilical vein endothelial cells (HUVECs), are known to release potent vasodilators, including nitric oxide (NO) and prostacyclins. Treatment of HUVECs with ozonated serum, an oxidative stressor, results in a significant and steady increase in NO production. Moreover, during twenty-four (24) hour HUVEC incubation with ozonated serum, inhibition of E-selectin release (a proinflammatory mediator) and no effect on endothelin-1 production (a potent vasoconstrictor) has been reported (Valacchi, G 2000). Valacchi et al. has suggested that reinfusion of ozonated blood into patients, by enhancing release of NO, may induce vasodilation in ischemic areas and reduce hypoxia.

CRP is a product of inflammation the synthesis of which by the liver is stimulated by cytokines in response to an inflammatory stimulus. CRP activates the classic complement pathway and participates in the opsonization of ligands for phagocytosis. Initially suggested as solely a biomarker and powerful predictor of cardiovascular risk, CRP now appears to be a mediator of atherogenesis. CRP has a direct effect on promoting atherosclerotic processes and endothelial cell activation. CRP potentially down regulates endothelial nitric oxide synthase (eNOS) transcription and destabilizes eNOS mRNA, which decreases both basal and stimulated nitric oxide (NO) release.

In a synchronous fashion, CRP has been shown to stimulate endothelin-1 (potent vasoconstrictor) and interleukin-6 release (proinflammatory cytokine), upregulate adhesion molecules, and stimulate monocyte chemotactic protein-1 while facilitating macrophage LDL uptake. More recently, CRP has been shown to facilitate endothelial cell apoptosis and inhibit angiogenesis, as well as potentially upregulate nuclear factor kappa-B, a key nuclear factor that facilitates the transcription of numerous pro-atherosclerotic genes. The direct pro-atherogenic effects of CRP extend beyond the endothelium to the vascular smooth muscle, where it directly upregulates angiotensin type 1 receptors and stimulates vascular smooth muscle migration, proliferation, neointimal formation and reactive oxygen species production. CRP has several deleterious effects (e.g., reduced survival, differentiation, function, apoptosis, and endothelial progenitor cell-eNOS mRNA expression) on endothelial progenitor cells which are important in neovascularization including induction of blood flow recovery in ischemic limbs and increase in myocardial viability after infarction.

Historically, ozone has been used as a disinfectant or sterilizing agent in a wide variety of applications. These include fluid-based technologies such as purification of potable water, sterilization of fluids in the semi-conductor industry, disinfection of wastewater and sewage and inactivation of pathogens in biological fluids. Ozone has also been used in the past as a topical medicinal treatment, as a systemic therapeutic and as a treatment of various fluids that were subsequently used to treat a variety of diseases. Specifically, there have been numerous attempts utilizing a variety of ozone-based technologies to treat an array of cardiovascular diseases in patients.

Previous technologies were incapable of measuring and differentiating between the amount of ozone that was delivered and the amount of ozone actually absorbed and utilized. This meant previous medicinal technologies for use in patients were incapable of measuring, reporting or differentiating the amount of ozone delivered from the amount that was actually absorbed and utilized. This problem made regulatory approval as a therapeutic unlikely. In the treatment of cardiovascular diseases, previous technologies were also incapable of measuring, reporting or differentiating the amount of ozone delivered from the amount that was actually absorbed by the fluid and utilized by the patient.

The inability to measure the amount of ozone absorbed may result in excessive absorption resulting in unacceptable levels of cellular necrosis in the leukocyte fraction of the treated blood, which when reinfused may result in promotion of an inflammatory response. Furthermore, any technology considered

to treat cardiovascular disease utilizing blood ex vivo with ozone may have to be able to maintain the biological integrity of the fluid for its subsequent intended therapeutic use.

In addition, early approaches of mixing ozone with fluids employed gas-fluid contacting devices that were engineered with poor mass transfer efficiency of gas to fluids. Later, more efficient gas-fluid contacting devices were developed, but these devices used construction materials that were not ozone inert and therefore, reacted and absorbed ozone. This resulted in absorption of ozone by the construction materials making it impossible to determine the amount of ozone delivered to and absorbed by the fluid. Furthermore, ozone absorption by construction materials likely caused oxidation and the subsequent release of contaminants or deleterious byproducts of oxidation into the fluid.

Experimental research confirms the problem of ozone absorption by construction materials. An ozone/oxygen admixture at 1200 ppmv was passaged through a commercially available membrane oxygenator. For a period in excess of two hours, a majority of the ozone delivered to the device was absorbed by the construction materials. This data strongly suggests commercially available membrane gas-fluid contacting devices, made from ozone reactive materials, cannot be used with ozone, and supports the necessity to develop novel ozone-inert gas-fluid contacting devices.

In addition, prior methods do not quantify the amount of ozone that does not react with the biological fluid. The inability to measure residual-ozone has led to inaccurate and imprecise determinations of the amount of ozone actually absorbed and utilized by the fluid.

Prior technologies also include inefficient methods to mix ozone with fluids yielding irregular exposure. For example, relatively large amounts of ozone may be exposed to some of the fluid and less to other portions. The result of this inefficient mixing causes a wide variation in the amount of ozone exposed to the fluid. This wide variation in ozone exposure may cause diverse biochemical events including unacceptable levels of cellular necrosis in various portions of the fluid leading to untoward and irreproducible results.

Prior techniques also failed to recognize that fluids of varying composition display different absorption phenomena. The range of values for extracellular antioxidants in blood, including ascorbic acid (0.4-1.5 mg/dL), uric acid (2.1-8.5 mg/dL), bilirubin (0-1.0 mg/dL) and Vitamin A (30-65 µg/dL) and other oxidizable substrates, including cholesterol (140-240 mg/dL), LDL-cholesterol (100-159 mg/dL), HDL-cholesterol (33-83 mg/dL) and triglycerides (45-200 mg/dL), may alter the amount of ozone necessary to be delivered to the fluid, and subsequently absorbed and utilized to achieve a desired clinical effect.



[54] METHOD FOR THE PHYSIOLOGICALLY & THERAPEUTICALLY EFFECTIVE IRRADIATION OF CORPOREAL VENOUS BLOOD

[75] Inventors: Joachim Fisch, Ilmenau; Hans-Richard Kost, Hildburghausen; Manfred Riemann, Ilmenau; Jör Sonnemann, Ilmenau; Gerda Fisch, Ilmenau, all of German Democratic Rep.

[73] Assignee: VEB Elektro-und Metallgeräte Ilmenau, Ilmenau, German Democratic Rep.

[21] Appl. No.: 271,343

[22] Filed: Nov. 10, 1988

Related U.S. Application Data

[63] Continuation of Ser. No. 169,071, Mar. 15, 1988, abandoned, which is a continuation of Ser. No. 841,972, Mar. 20, 1986, abandoned.

Foreign Application Priority Data

Mar. 20, 1985 [DD] German Democratic Rep. ... 274282

[51] Int. Cl.<sup>4</sup> ..... G01N 23/12; A61L 2/00; H01J 37/00

[52] U.S. Cl. .... 250/432 R; 250/504 R; 250/435; 422/21

[58] Field of Search ..... 250/492.1, 432 R, 504 R, 250/435, 431, 503.1, 453.1; 422/24, 44; 128/395, 397, 398; 604/4

[56] References Cited

U.S. PATENT DOCUMENTS

Table with 4 columns: Patent Number, Date, Inventor, and Patent Number. Rows include Roesler et al. (250/504 R), Clark (604/4), Taylor et al. (250/435), Fuse et al. (250/492.1), and Lamboo (362/219).

FOREIGN PATENT DOCUMENTS

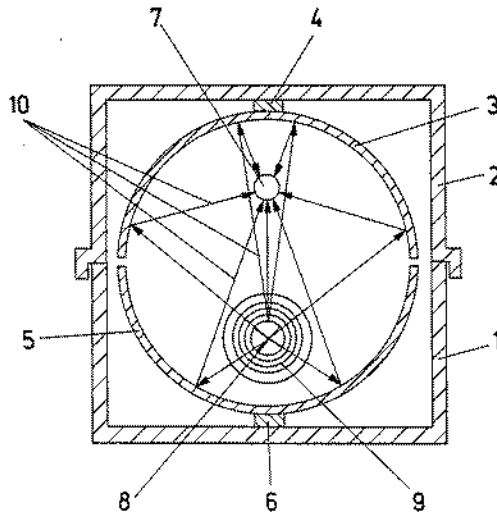
Table with 4 columns: Patent Number, Date, Country, and Patent Number. Rows include Fed. Rep. of Germany (422/44), France (250/432 R), France (250/493.1), France (250/432 R), and Japan (250/504 R).

Primary Examiner—Bruce C. Anderson
Attorney, Agent, or Firm—Schweitzer & Cornman

[57] ABSTRACT

A method for the radiation of corporeal blood is described with which it is possible to prevent arteriosclerosis related heart and vascular diseases due to disturbances in the fat exchange, or to successfully fight such diseases, without exposing the blood to photosensibilizers or without the necessity of additional corporeal activity, or a special diet. The apparatus is easily transportable, independent from electrical supply lines and may, for example, be operated from the energy obtained from a car battery. A radiation spectrum is used, which employs optical radiation types, which are available on the surface of the earth in nature, so that damages to the organism in principle are prevented.

5 Claims, 2 Drawing Sheets



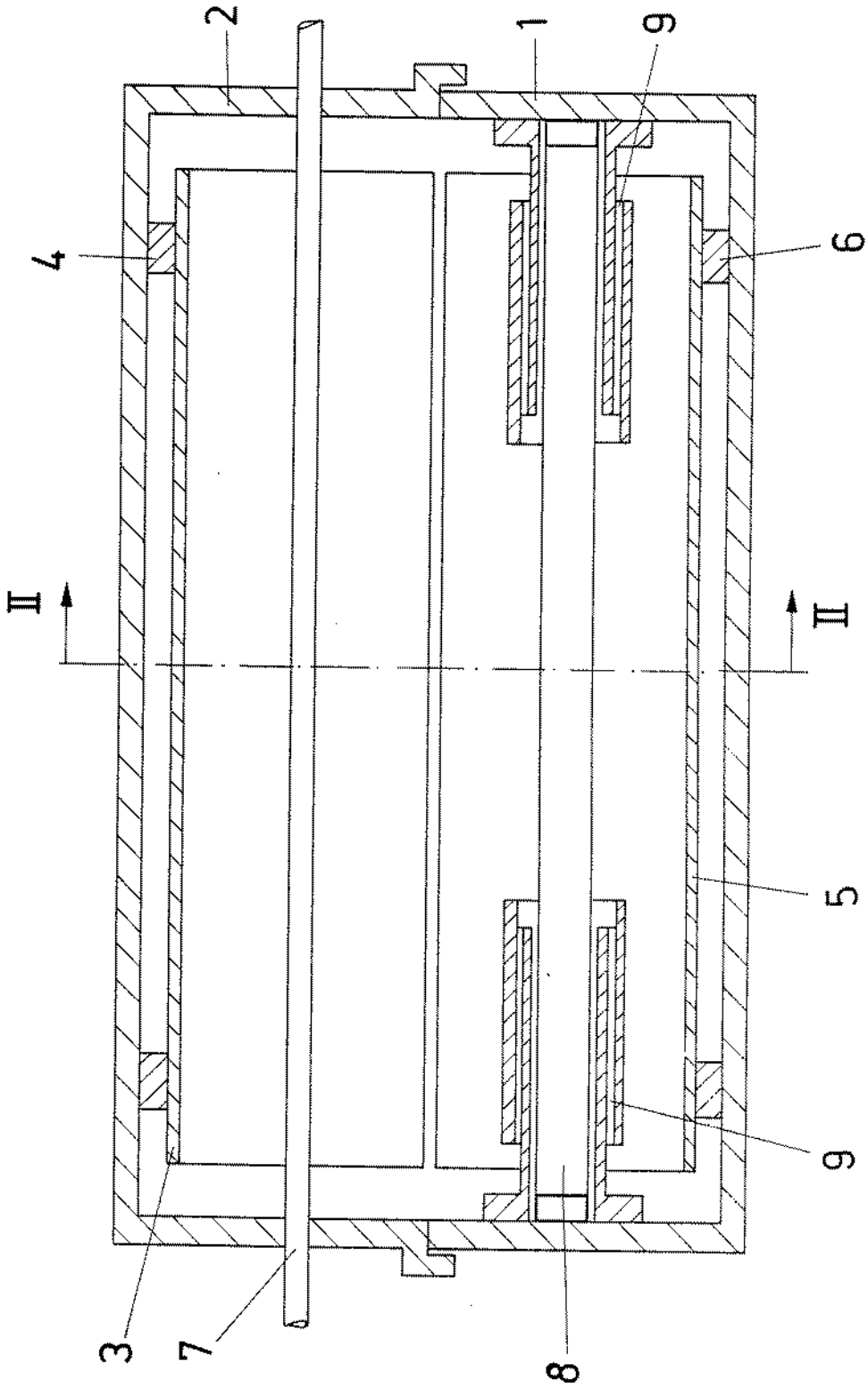


Fig. 1

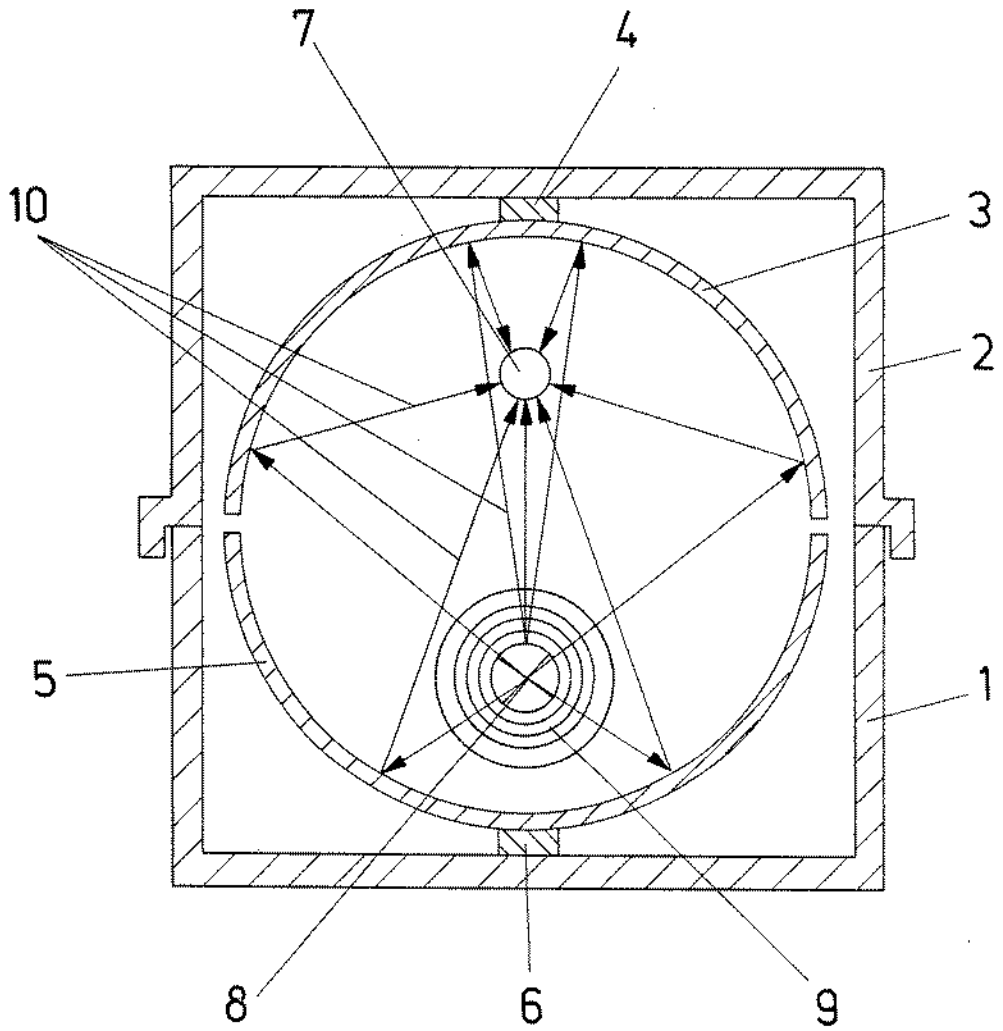


Fig. 2

## METHOD FOR THE PHYSIOLOGICALLY & THERAPEUTICALLY EFFECTIVE IRRADIATION OF CORPOREAL VENOUS BLOOD

This is a continuing application of U.S. Ser. No. 169,071, filed on Mar. 15, 1988, now abandoned, which is a continuation of application for United States Letters Patent Ser. No. 841,972, filed on Mar. 20, 1986, now abandoned.

### FIELD OF THE INVENTION

The present invention relates to an apparatus with the help of which the irradiation of corporeal venous blood, especially the UVA region and in the blue light region becomes possible. Such apparatuses and devices especially for blood processing have been introduced since some time and used in the medical profession. The users firmly believe in the physiologically and therapeutically effective blood processing.

The object of the subsequently described technical solution resides in that the blood should be influenced in such a manner that by an increased oxygen acceptance the regenerating processes which go on in the body, such as the fat exchange, should be accelerated. During this certain disturbed biological parameters, such as the low Density Lipoproteins should be changed to High Density Lipoprotein-cholesterol in a positive sense and in favor of the vascular protective balance (HDL-C).

### DESCRIPTION OF THE PRIOR ART

There have been apparatuses and devices known with which the oxygen/ozone gas mixture is applied subcutaneous, intramuscularly, intravenously or by insufflation. For example, in East German Pat. No. 14,127 a device for the oxygen enrichment of a continuously flowing blood stream is described, in which by foaming-up the blood by oxygen the upper surface thereof is increased.

Furthermore, devices and apparatuses are known in which the blood in a quartz glass vessel (cell or bulb) is flowed by a UV radiator for purposes of radiation, such as described in West German Pat. Nos. 1,065,140 and 1,071,291, as well as in West German Laid-Open Application No. 2,926,523. Such apparatuses require a very large technical layout for the apparatus, and wherein the apparatus becomes reused as a matter of rule. The disadvantage resides in that the blood may become overheated and the disinfecting requirements are very complex and there is a danger of transferring and spreading of germs (virus, hepatitis, aids, etc.), since no disposable material is used by them.

There are also devices known for some time, in which the blood becomes foamed-up by means of oxygen and it is also subjected to an ultraviolet radiation. For example, in West German Pat. No. 957,877 and in West German Laid-Open Application No. 1,215,867 devices are described for the processing of blood, blood plasma or similar materials, with oxygen and also with ultraviolet radiation.

Also with them complex devices are required, and all have the already known and above-mentioned disadvantages. In addition, due to the increased upper surface by the foaming, the intensity of the radiation becomes uncontrollable which may lead to cell or gene damages.

In U.S. Pat. Nos. 4,321,919 and 4,464,166 a method is described in which corporeal blood of the person under

test is passed by a pump through a radiation chamber and through a centrifuge and again back into the body. The sterilization requirements must be observed during this to an extremely high degree and the technical layout of the apparatus is considerable. In addition, all the above-mentioned disadvantages are present also here.

A third solution is described in West German Laid-Open Application No. 2,943,310A1 according to which by means of a light conducting cable introduced by puncturing a UV-radiation is introduced into the blood vessel system and thereby a biophysical effect is attained. The main disadvantage of such procedure resides in the above-mentioned possible transfer of germs, due to the fact that the sterilization of the reusable light cable is complicated.

All the so far mentioned apparatuses and devices require a considerable technical and medical effort. Economical, personnel and sterilization problems considerably limit their use. Contaminations or transfer of germs in the blood in many of the procedures cannot be avoided. A false dosing or metering of the gas used in the foaming-up of the blood, for example, oxygen and also of the UV radiation, due to human error, may lead to life endangering complications, such as embolism, gene or cell destruction. The cleaning and the sterilization of the known apparatus and devices is very complicated. In the above-described known procedures for blood irradiation usually UVC radiators are used, which have a main emission line of 253.7 nm. Such wavelength so far has been reserved for essential therapeutical treatments. Latest research shows that the relatively hard, energy rich UVC radiation in the event of excessive doses, may lead to damages of the biological cells and tissues. Such damages may lead to deterioration of the blood producing system (leukemia) and other inheritable damages.

### SUMMARY OF THE INVENTION

It is, therefore, an object of the present invention to provide an apparatus, which:

Does not present a danger for the person under testing and employs mainly optical radiation, predominantly in the UVA and blue light regions;

From the hygienic viewpoint it enables substantial improvements and assures the observation of the legal requirements;

Its technical reliability is substantially improved and can be operated from a conventional energy supply as well as from a low voltage source;

It is small, light, independent from the conventional energy supply and thereby it is mobile;

It is inexpensive to make and possesses a very high serviceability.

A further object of the present invention resides in the provision of an apparatus, in which a radiation is used which is in the radiation range of the sun radiation available on the surface of the earth and in which an exact metering of the radiated quantity is assured.

According to a further object of the present invention the oxygen reception is improved without foaming-up or additional corporeal activity and thereby the peripheral microcirculation is improved, thereby any fat exchange disturbances of the body are positively influenced.

Furthermore, the radiation strength in each radiation period must be uniform and the blood should be brought in contact only with disposable materials.

The apparatus for the physiological and therapeutical optical irradiation of corporeal venous blood according to the present invention comprises a radiator, which emits radiation mainly in the wavelength region of 320 nm to 600 nm.

A hose which is arranged substantially parallel to such in radiator is made from a disposable material will be flown through by venous blood treated with sodium citrate or another type of anticoagulant, and exposed to radiation. By the reflections it will assured that the hose becomes uniformly radiated from all sides with the blood flowing therethrough. It is therefore preferred that the radiator as far as the hose be disposed in the focus of a reflector formed by conical sections. The irradiator, the hose and the reflectors are arranged in a housing having a cover and supported therein by known securing means. The hose is tightly secured or tensed in the housing in clamping devices which may take the form of conical slots, to avoid any slack in it. The flow-rate of the blood can be regulated by means of a hose clamp provided on the housing. Around the radiator there is provided is sleeve-like telescope arrangement, with which by displacing a telescoping sleeve, the length of the radiation emitting portion of the irradiator can be adjusted.

In addition the intensity of the radiation of the radiator can be adjusted by adjusting the applied voltage. For this reason, outside of the housing in the supply cable a switch, for example, of the type EVG UVAP1 manufactured by the Technical High School in Ilmenau, is arranged.

For radiation preferably a xenon lamp, argon lamp or a mercury-low pressure discharge lamp of the type L S4 of Narva II., can be used.

In addition it is possible to vary the frequency spectrum by providing suitable luminous materials such as the three-band luminous materials and with the help of varying the blue component a irradiator which emits an unsuitable or too wide frequency spectrum can be adjusted to the desired frequency range of 320 nm to 600 n.

The quantity of the irradiation on the blood can be varied by various means. The length of the irradiated hose section can be varied with the help of the telescopic arrangement placed on the radiator, as well as the intensity of the irradiation can be controlled by changing the high frequency input to the irradiation and furthermore the quantity of the blood flowing through the hose can be adjusted by a conventional hose clamp or other similar means by narrowing the cross section of the hose. It can be understood that by changing all three means, the irradiation dose to which the blood is exposed, can be exactly set, whereby the mentioned three means are preferably varied in the following quantities:

Radiation intensity: between  $1 \text{ mWcm}^{-2}$  and  $10 \text{ mWcm}^{-2}$ ;

Length of the irradiated hose section: 1 cm to 30 cm;

Flow-rate of the blood: 20 to 80 drops per minute.

With the help of the apparatus according to the present invention it becomes possible to prevent arteriosclerotic heart or blood vessel deteriorations caused by disturbances in the fat exchange, especially they could be effectively counted, without adding to the blood photosensibilators, such as Psoralens, described by Edelson. During this additional corporeal activity and dietetic measures are desirable, however, they are not absolutely required. Also by using disposable materials,

the spreading of infectious diseases, such as aids and hepatitis B is completely eliminated.

The employed radiation type completely avoids any DNA damage or the inducement of cancer, since only optical radiation is used, which is available on the surface of the earth in nature. At the same time the radiation is performed in a frequency region in which the erythrocytes will absorb the offered radiation to a maximal extent.

The apparatus is easily transportable, hygienic and can be set up in any situation without relying on the current supply, that is, it can have its energy supply from a car battery. It is inexpensive to manufacture and requires small material layout and it is also easy to service.

#### DESCRIPTION OF THE DRAWINGS

The invention will be explained with reference to the attached drawings, in which:

FIG. 1 is a schematic sideview of the apparatus according to the present invention, in section, and

FIG. 2 is a schematic sectional illustration along the line II--II in FIG. 1.

#### DESCRIPTION OF SPECIFIC EMBODIMENTS

The following embodiment serves only for illustration and for a better understanding of the invention, and the invention itself should not be limited thereby since it represents only one possible form of illustration.

A possible embodiment of the present invention illustrated in FIG. 1 and FIG. 2 shows a housing 1, which can be closed by a cover 2. In cover 2 there is a reflector 3 secured by any well known not illustrated in detail means 4, such as screws or rivets provided with rubber backing. A further similar reflector 5 is secured within the housing 1 with similar means 6. In the focus of the reflectors 3 provided in the cover 2 a PVC hose 7 is arranged, which is supported by means of suitable securing elements and is spanned or tensioned by spring means so that it will lie exactly in focus substantially along the entire length of the reflector. The securing elements and the springs have been omitted for improving the understanding of the schematic illustration. In the focus of the reflector 2 provided in the housing 1 a irradiator 8 is arranged, the radiation emitting length of which can be adjusted with the help of a telescopic arrangement 9, which is arranged in a pipe-like fashion about the irradiator 8. The radiator 8 is operated with the help of an electronic switching device (not illustrate), for example the EVG UVAB1 manufactured by the Technical High School Ilmenau, having a variable HF output, and which can be placed in the housing 1, 2 or outside of the housing 1, 2 or also as an intermediate element inserted in the supply cable.

The venous blood becomes guided through the PVC hose 7 through the cover 2 of the housing 1, 2 along the irradiator 8. The length of the hose section which is to be radiated and thereby the amount of the radiation as well as the exposure of the blood to radiation can be set with the help of the telescopic arrangement 9 by reducing the possible length of emission of the irradiator 8. By arranging the PVC hose 7 and the irradiator 8 in the focal point of the reflectors 3, 5, it is attained that a maximum value of the radiation emitted by the irradiator 8 will be directed onto the PVC hose 7. By an appropriate dimensioning of the housing 1 and of the cover 2, one will attain that there will be a desired distance or spacing present between the irradiator 8 and the PVC

hose 7 in an exact amount, whenever the cover 2 is seated on the housing 1. The reflectors 3, 5 are shaped and a curvature is formed in such a manner, that at such spacing the PVC hose 7 will receive the largest amount of radiation. The reflectors are also shaped in such a manner that the most possible rays of radiation 10 will be directed from irradiator 8 onto the PVC hose 7. The possible paths of the radiated rays 10 are schematically illustrated in FIG. 2.

For a switching device preferably a known serial-type device is used (for example, the type known as EVG UVABI manufactured by the Technical High School in Ilmenau), which can be operated with low voltage of 42V or from the regular current supply, for example, 110/220V. The device in such form is transportable, it is easy to be handled and used. For hygienic reasons the PVC hose 7 is manufactured as a disposable material, such as the blood transfusion device MLW Lichtenberg and becomes destroyed after use.

It can be seen that it is also possible to arrange the telescopic arrangement 9 only on one side of the housing, or to replace it by a different type of cover, such as a rotatable pipe-like hood with a spiral-shaped edge, which is arranged surrounding irradiator 8 and by being rotated it can change the free radiating length of the irradiator 8.

The above-noted embodiment describes only a possible form of realization of the invention only for better information and should not limit the scope of the invention to such embodiment alone. The scope of protection should be defined by the claims. Variations which would be obvious for an expert in the field and limita-

tions, such as, the reflectors on the radiator or on the ends of the hose between the housing elements, should lie within the scope of the claims defining the invention.

What is claimed is:

1. A process for physiological and therapeutic treatment of venous blood from a body, which comprises (a) introducing the blood into an apparatus having a blood conducting tube of medically acceptable disposable material, at least on elongated radiator for emitting electromagnetic radiation, a reflector for distributing the radiation of said radiator substantially about said tube, and means for controlling the radiation that reaches said tube from said radiator, (b) conducting the blood through said blood conducting tube at a flow rate of from about 20 drops/minute to about 80 drops/minute, and (c) irradiating the blood in the blood conducting tube with radiation from said radiator at an intensity of from about 1 mWcm<sup>-2</sup> to about 10 mWcm<sup>-2</sup> in the wavelength range of from about 320 nm to about 600 nm.

2. The process of claim 1, wherein the length of the blood conducting tube that is exposed to the electromagnetic radiation is from about 1 cm to about 30 cm.

3. The process of claim 1, wherein said means for controlling the radiation comprises telescoping adjustable tubular shrouds.

4. The process of claim 1, wherein the spectral emission of said radiator is adjusted by a coating of luminous material on said radiator.

5. The process of claim 1, wherein said radiator is a xenon lamp.

\* \* \* \* \*

35

40

45

50

55

60

65

[54] APPARATUS FOR THE PRODUCTION OF OXYGENATED BLOOD

[75] Inventors: Alexander Müller, Essen; Hans-Dieter Jentiens, Radevormwald-Bergerhof, both of Fed. Rep. of Germany

[73] Assignee: Quarzlampenfabrik Dr.-Ing. Felix W. Müller GmbH & Co. KG, Essen, Fed. Rep. of Germany

[21] Appl. No.: 117,519

[22] Filed: Nov. 4, 1987

[30] Foreign Application Priority Data

Jan. 15, 1987 [DE] Fed. Rep. of Germany ... 8700628[U]

Mar. 26, 1987 [DE] Fed. Rep. of Germany ... 8704467[U]

[51] Int. Cl.<sup>5</sup> ..... A61M 1/14

[52] U.S. Cl. .... 422/45; 422/24; 250/495.1; 250/504 R

[58] Field of Search ..... 422/45, 24; 250/495.1, 250/496.1, 504 R

[56] References Cited

U.S. PATENT DOCUMENTS

2,827,901 3/1958 Jones ..... 422/45

FOREIGN PATENT DOCUMENTS

2456932 6/1976 Fed. Rep. of Germany ..... 422/45

Primary Examiner—Robert J. Warden

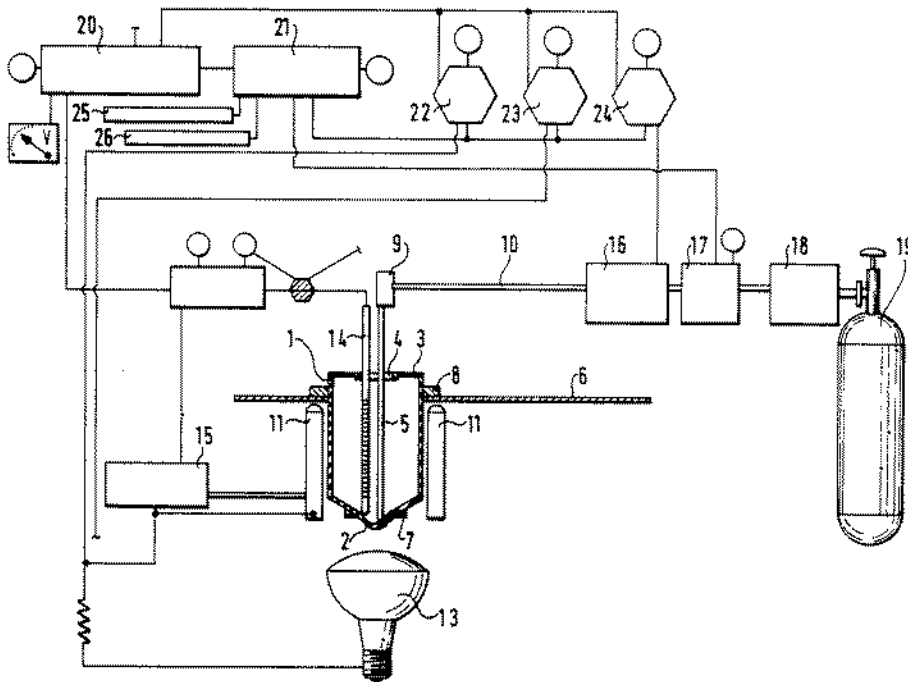
Assistant Examiner—Lynn Kummert

Attorney, Agent, or Firm—Herbert Dubno

[57] ABSTRACT

An apparatus is disclosed for the production of oxygenated blood. The apparatus incorporates a vessel for containing the blood that is to be processed, an ultraviolet lamp and an infrared lamp being associated with the vessel. A feed pipe extends into the vessel to a position near the bottom of the vessel, such feed pipe being connected to a source of ozone. The vessel is essentially in the form of an inverted bottle, the neck opening of which is closed and the base of which incorporates a central opening for the feed pipe, the vessel and the feed pipe being designed as disposable items. The vessel is installed in the area of a working surface of the apparatus so as to be releasable therefrom, while the feed pipe is connectable to a coupling on a line that leads to the ozone source.

31 Claims, 2 Drawing Sheets



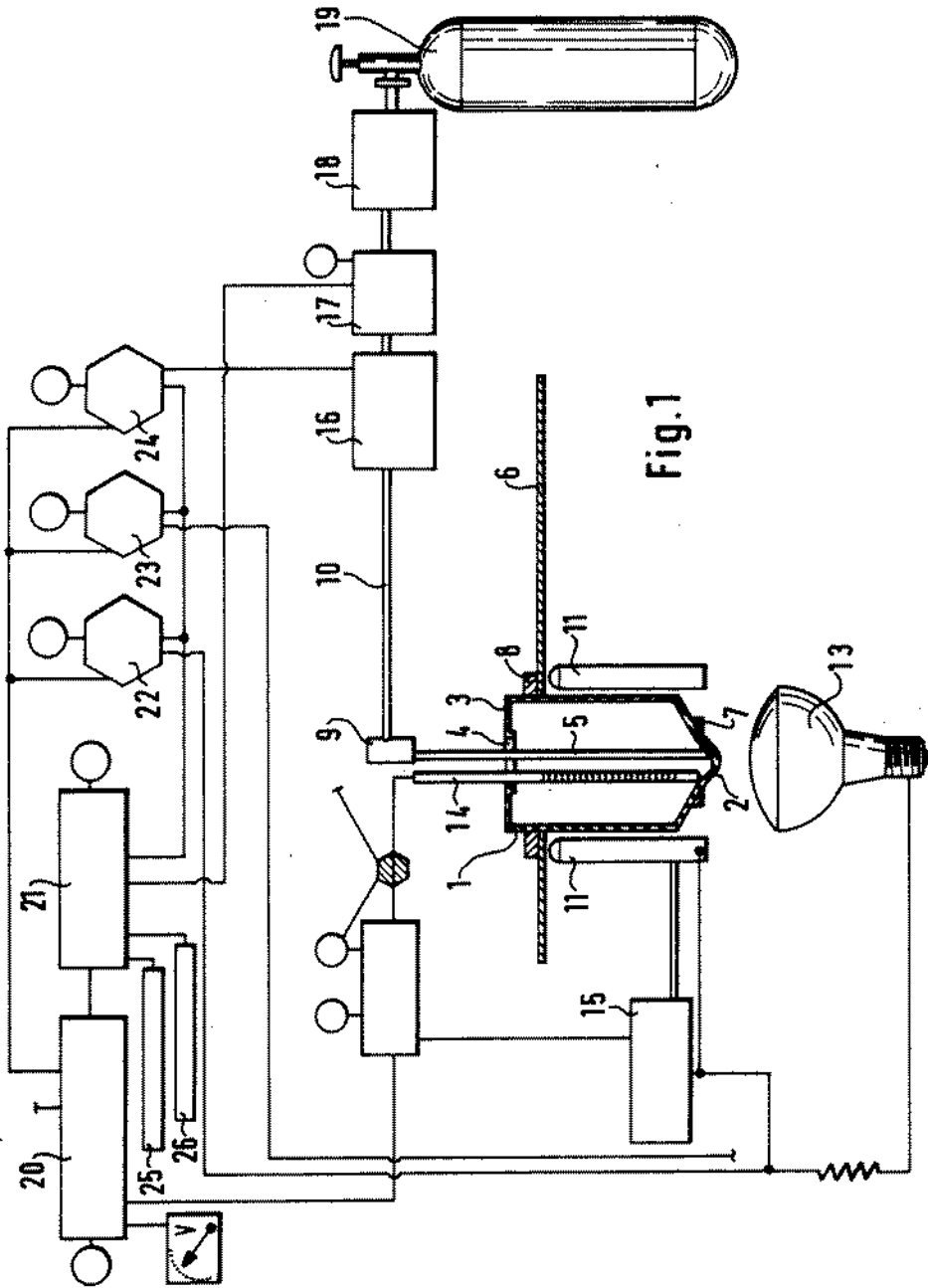


Fig. 1



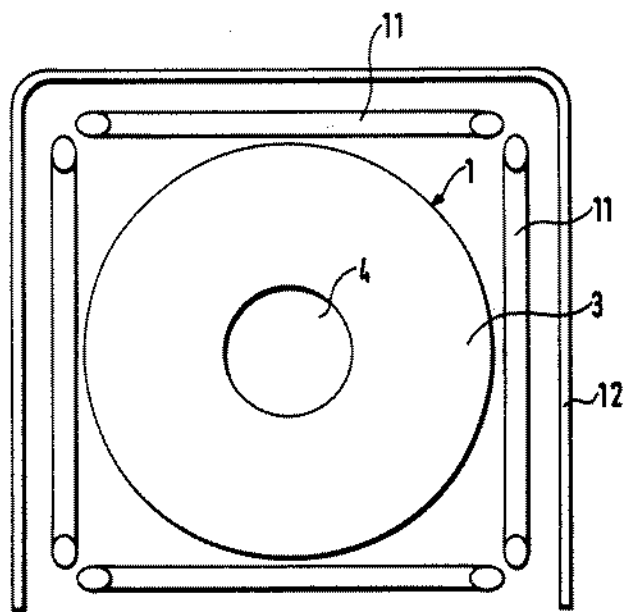


Fig. 2

## APPARATUS FOR THE PRODUCTION OF OXYGENATED BLOOD

### FIELD OF THE INVENTION

The present invention relates to an apparatus for the production of oxygenated blood, said apparatus incorporating a vessel to contain the blood that is to be treated, an ultraviolet lamp and an infrared lamp being associated with the container, a feed pipe that is connected to a source for ozone and that reaches to its bottom area extending into the container.

### THE RELATED ART

It is known that for purposes of haematological oxidation therapy, after a stabilizing agent against coagulation has been added to it, human or animal blood can be processed with air while being irradiated with ultraviolet radiation; when this is done, the flow of air that is introduced into it converts the blood into foam that moves within the ultraviolet radiation. The foam that is so formed is destroyed by the blood returning to its liquid state. Oxygenated blood that is processed in this way can be injected intramuscularly or intravenously.

However, under certain conditions that have not been researched further, blood that has been oxygenated in this manner can give rise to shock reactions, a fact that renders haematological oxidation therapy difficult. The difficulties may be connected with the decomposition of erythrocytes when oxygen acts on the foamed blood, which can be recognized by the unpleasant smell of the reaction media.

In order to avoid these disadvantages, DE-PS 1 068 428 has proposed that ozone be passed through a continuous column of liquid, stabilized, venous blood in an area of ultraviolet radiation such that no significant foaming takes place, with the temperature being increased gradually to approximately 45° C. during this process. An approximately funnel-shaped vessel of material that is transparent to ultraviolet radiation is used, and this vessel is surrounded by a coiled ultraviolet quartz lamp as well as by an infrared radiator. A feed pipe enters the top of the processing vessel and extends within the vessel to a point close to its bottom; outside the processing vessel, this feed pipe is connected to an ozonizing chamber within which there is a low-pressure quartz lamp that ozonizes the oxygen that is supplied to the ozonizing chamber. This known apparatus has been found satisfactory, although it is comparatively costly to produce and extremely inconvenient to use.

Proceeding from this prior art, it is the object of the present invention to create an apparatus of the type described in the introduction hereto, which avoids the disadvantages set out above and which is not only simple to produce and install, but which, in addition, permits rapid and safe operation.

### SUMMARY OF THE INVENTION

According to the present invention, this has been achieved in that the vessel is essentially in the form of an inverted bottle, the neck opening of which is closed, and the bottom of which incorporates a central opening for the feed pipe; both the vessel and the feed pipe are designed as disposable items. The vessel is installed in the area of a working surface of the apparatus so as to be releasable. The feed pipe can be connected to a coupling for a line that leads to the ozone source. This configuration results in rapid and safe operation, for the

sterile vessel is filled with blood that is removed from the patient and is installed in a holder provided for this purpose as part of the apparatus, whereupon the sterile feed pipe in the form of a tube is inserted into one end until it is close to the bottom of the apparatus; the other end is connected to the coupling on the line that leads to the ozonizer. When the apparatus is switched on, the blood within the container is exposed to ultraviolet irradiation and to infrared heating to a maximum of 45° C., whereupon the apparatus is switched off and the oxygenated blood removed by means of a syringe and injected either intravenously or intramuscularly into the patient. The holders are released and the vessel and the feed pipe are removed from the apparatus and discarded so that further processing can take place with new sterile vessels and feed pipes.

The neck opening of the bottle is closed tightly by means of a cover that is curved outwards, so that a gap is left between the face end of the feed pipe that rests on the cover, the ozone that is introduced into the vessel being able to emerge unhindered through this gap.

The neck of the vessel, which is fitted with the cap, is of the approximate form of a lobe, so that the blood is retained in a comparatively small space to undergo intensive exposure to the ozone. The volume of the vessel is such that its contents are sufficient for a maximum quantity of foamed blood, with a specific reserve so that the foamed blood can never emerge from the opening of the vessel. The vessel is of low-density polyethylene that is of high quality, transparent to ultraviolet wavelengths, pyrogen-free, and can be sterilized by irradiation. These vessels are packed individually and sealed in pouches, whereby irradiation sterilization also renders them aseptic.

The vessel is surrounded by a plurality of low-pressure ultraviolet lamps that generate the ultraviolet radiation required for processing the blood in connection with haematological oxidation therapy. These low-pressure ultraviolet lamps generate a line spectrum in which it is preferred that the line 253.7 nm accounts for the greatest part of the radiation, namely, approximately 90 per cent. This results in highly-effective sterilization and a high degree of asepsis. The low-pressure ultraviolet lamps are U-shaped, it being preferred that four be provided, these being displaced at 90° relative to each other around the vessel. The low-pressure ultraviolet lamps can be produced and installed very simply because of their U-shape, so that only a comparatively small expenditure is needed to achieve this. It is preferred that the low-pressure ultraviolet lamps be produced from ozone-free quartz.

According to another feature of the present invention, the vessel and the greater part of the low-pressure ultraviolet lamps that surround it are enclosed by a U-shaped reflector so that the radiation emitted from the back and sides of the lamps is captured and reflected back onto the vessel, the walls of which are transparent to ultraviolet radiation, this ensuring a high degree of effectiveness of the ultraviolet radiation on the blood to be processed.

It is advantageous that the infrared lamp be arranged beneath the vessel, so that warming takes place from below. Such an arrangement permits an extremely compact structure which, at the same time, ensures intensive warming of the blood that is to be processed within the vessel.

The vessel is fitted with a thermometer so that the increase in temperature can be monitored and controlled very accurately. Like the feed pipe for the ozone, the thermometer can extend into the vessel. However, it is also possible to arrange the thermometer outside the vessel, for example, as a non-contact type thermometer. This latter arrangement entails the advantage that the thermometer need not be configured as a disposable item that has to be discarded, with the vessel and the feed pipe, once processing has been completed, but can be installed permanently as a result of the fact that it is installed outside the vessel.

It is advantageous that a thermocouple be used as the thermometer. On reaching a temperature of 42.5° C. this thermocouple transmits a pulse that switches the apparatus off. The thermocouple consists of a thick-wall glass tube within which two unlike metal wires, preferably of iron and of constantan, are arranged. The ends of these wires are connected to each other within the tip of the tube. The connection point of these two wires of the thermometer is imbedded in casting resin so as to ensure the optimum thermal transfer from the surrounding medium.

An ozonizer that is connected through a solenoid valve to an oxygen cylinder or the like serves as the source of ozone. The ozonizer is fitted with one or a plurality of low-pressure ultraviolet lamps and the radiation from these converts the oxygen from the oxygen cylinder into ozone. The low-pressure ultraviolet lamp(s) emit(s) a line spectrum in which line 183 nm accounts for the major part of the overall radiation, and this results in highly efficient generation of ozone. The ozonizer is connected to a normal power supply and is not powered by high-tension voltage, which ensures a longer service life. It is advantageous that the oxygen cylinder be fitted with a pressure monitoring system that indicates the charge pressure of the oxygen cylinder and which switches the apparatus off in the event that the pressure drops below a prescribed value.

It is also possible to use an oxygen-generating system in place of the oxygen cylinder, so that there is then no need to replace the oxygen cylinders.

According to a further feature of the present invention, the electrical circuit incorporates a master switch, a processing switch, and switches that control the low-pressure ultraviolet lamps, the infrared heater, and the ozonizer; all of the foregoing switches can be operated separately. The individual systems within the apparatus are advantageously interconnected so that when the processing switch is turned on, all the systems are activated; this ensures that when blood is being processed, this blood is not only supplied with ozone, but is also exposed to infrared and ultraviolet radiation. It is possible to switch the apparatus off by a timer switch or as a function of the blood temperature that is reached.

In addition to the foregoing, a timer and/or a counter can also be connected to the processing switch, in order to count the number of processing cycles completed, or the duration of the processing cycles.

It is advantageous that the feed tube consist of a thick-walled glass tube that can be connected to the source of the ozone by means of a short section of tubing, this resulting in a version that is durable and easy to use.

#### BRIEF DESCRIPTION OF THE DRAWING

An embodiment of the present invention is described in greater detail below, on the basis of the drawings appended hereto. These drawings show the following:

FIG. 1: A schematic representation of the circuit for the systems in the apparatus.

FIG. 2: A plan view of the vessel used to process the blood.

#### DETAILED DESCRIPTION

A vessel 1, essentially in the form of an inverted bottle, has its neck opening closed tightly by means of a cover 2. The vessel 1 is produced from low-density plastic, such as polyethylene, in the same manner as a milk jug. The base 3 of the vessel is provided with a central opening 4 for the feed pipe 5. The feed pipe 5, which is produced from plastic tubing, and the vessel 1 are produced as disposable items, so that these are discarded once they have been used.

The vessel 1 is installed so as to be removable in a working surface 6 in a holder, the holder not being shown in greater detail herein in the interests of clarity. To this end, the vessel is installed in a lower retaining ring 7 and in an upper retaining ring 8. Such an arrangement makes it possible to install the vessel in the apparatus quickly and easily, and then remove it from this once the blood has been processed.

The feed pipe 5 that extends into the vessel 1 can be connected at the coupling 9 on a line 10 that leads to an ozone supply system. This coupling 9 is a conventional pipe or tube coupling so that the feed pipe 5 can also be replaced quickly and easily.

The face surface of the lower end of the feed pipe 5 rests on the cover 2 of the vessel 1, this cover being curved outwards so that the ozone that is introduced can disperse through the gap formed in this way within the vessel 1 and then flow through the blood contained therein.

The vessel 1 is surrounded by a plurality of low-pressure ultraviolet lamps, these being of a U-shaped configuration in the embodiment shown. Four such lamps 11 are installed, and these are arranged at 90° to each other. The ultraviolet lamps 11 radiate a line spectrum in which line 253.7 nm accounts for the greater part of the radiation, for example, some 90 per cent, so that highly effective irradiation of the blood contained within the vessel 1 can be achieved, and together with this, the desired disinfection and sterilisation of the blood.

As can be seen from FIG. 2, the vessel 1 and the greater part of the low-pressure ultraviolet lamps 11 that surround the vessel, namely three of the burners, are surrounded by a U-shaped reflector 12, so that the radiation emanating from the low-pressure ultraviolet lamps 11 to the side and to the rear can also be utilized. Only one of the lamps 11 is not so enclosed, so that it is possible to monitor the vessel visually as the blood contained therein is being processed.

An infrared lamp 13 is arranged within the apparatus beneath the vessel 1; the output of this infrared lamp can be adjusted. The infrared radiation from this lamp warms the blood contained in the vessel 1, and the ozone passing through the blood simultaneously ensures that it is warmed uniformly.

In order that the extent to which the blood within the vessel can be monitored and adjusted, a thermometer extends into the vessel 1 through the opening 7 together

with the feed pipe 5. In the embodiment shown, the thermometer 14 is also a disposable item so that this, together with the vessel 1 and the feed pipe 5, is replaced once the blood has been processed. However, it is also possible to provide a non-contact type thermometer, as a fixed component, in addition to or in place of the thermometer 14.

In the embodiment shown, an ozonizer 16 is used as a source of ozone; this ozonizer is connected to the line 10, and is connected through this and the solenoid valve 17 to an oxygen cylinder 19 that is fitted with a pressure gauge 18. The ozonizer 16 is fitted with at least one low-pressure ultraviolet lamp that also emits a line spectrum, line 183 nm accounting for the greatest part of the total radiation emitted by this lamp.

The electrical circuit for the apparatus incorporates a master switch 20, a processing switch 21, and switches 22, 23, and 24 for the infrared lamp 13, the ultraviolet lamps 11, and the ozonizer 16 respectively. The individual systems, discussed above, that make up the apparatus are so interconnected that all of them are activated when the processing switch 21 is set to the "On" position, thereby ensuring that the blood contained within the vessel 1 does in fact undergo processing by all the necessary components.

A timer 25 and/or a counter 26 can be connected to the processing switch 21.

All the components in the electrical circuit are safeguarded by warning lights so that it is always possible to monitor the proper operation of said components.

What is claimed is:

1. An apparatus for production of oxygenated blood, said apparatus comprising a vessel for containing blood that is to be processed, an ultraviolet lamp and an infrared lamp positioned to radiate output toward the vessel, a feed pipe extending into the vessel to a position near a bottom of the vessel, the feed pipe being connected to a source of ozone, wherein the vessel with a narrow neck and broad base at opposite ends is essentially in a form of an inverted bottle, a neck opening of which is closed and forms the bottom of the vessel, the base forming a top of the vessel and including means defining a central opening for the feed pipe, the vessel and the feed pipe being designed as disposable items, the vessel being installed in an area of a working surface of the apparatus so as to be releasable therefrom, while the feed pipe is connectable to a coupling on a line that leads to the ozone source.

2. An apparatus as defined in claim 1, wherein the neck opening of the bottle is firmly closed by a cover that is curved outwards.

3. An apparatus as defined in claim 2, wherein the neck of the vessel that is provided with a cover is in the approximate form of a lobe.

4. An apparatus as defined in claim 1, wherein the vessel is made of a material comprising a low-density polyethylene.

5. An apparatus as defined in claim 4, wherein the material for the vessel is of a high-quality, is transparent to ultraviolet wavelengths, is free of pyrogens, and can be sterilized by irradiation.

6. An apparatus as defined in claim 1, wherein the vessel is surrounded by a plurality of low-pressure ultraviolet lamps.

7. An apparatus as defined in claim 6, wherein the low-pressure ultraviolet lamps are produced from ozone-free quartz.

8. An apparatus as defined in claim 6, wherein the low-pressure ultraviolet lamps radiate a line spectrum in which line 253.7 nm accounts for the greatest part of the overall radiation.

9. An apparatus as defined in claim 8, wherein the low-pressure ultraviolet lamps radiate a line spectrum in which line 253.7 nm accounts for at least approximately 90 per cent of the overall radiation.

10. An apparatus as defined in claim 6, wherein the low-pressure ultraviolet lamps are U-shaped.

11. An apparatus as defined in claim 6, wherein four low-pressure ultraviolet lamps are positioned around the vessel.

12. An apparatus as defined in claim 6, wherein the vessel and a major part of the low-pressure ultraviolet lamps are surrounded by a U-shaped reflector.

13. An apparatus as defined in claim 1, wherein the infrared lamp is arranged beneath the vessel.

14. An apparatus as defined in claim 1, wherein a thermometer is in contact with the vessel.

15. An apparatus as defined in claim 14, wherein the thermometer extends into the vessel through the base of the vessel.

16. An apparatus as defined in claim 15, wherein the thermometer comprises a thermocouple.

17. An apparatus as defined in claim 16, wherein a means is provided permitting the thermocouple to transmit a pulse to switch off the apparatus when a temperature of 42.5° C. is reached.

18. An apparatus as defined in claim 16, wherein the thermocouple consists of a thick-walled glass tube, within which two wires of dissimilar metal are arranged, the ends of which are connected to each other in a tip of the glass tube.

19. An apparatus as defined in claim 18, wherein the point of connection of the two wires forming the thermocouple is imbedded in casting plastic.

20. An apparatus as defined in claim 18, wherein the thermocouple wires of dissimilar metal are iron and constantan.

21. An apparatus as defined in claim 14, wherein the thermometer is arranged outside the vessel.

22. An apparatus as defined in claim 21, wherein a non-contact type of thermometer is used as the thermometer.

23. An apparatus as defined in claim 1, wherein the feed pipe consists of a thick-walled glass tube connected to the source of ozone by means of a short section of tubing.

24. An apparatus as defined in claim 1, wherein an ozonizer is used as a source of ozone, connected to an oxygen cylinder through a solenoid valve.

25. An apparatus as defined in claim 24, wherein the ozonizer has at least one low-pressure ultraviolet lamp that radiates a line spectrum in which line 183 nm accounts for the greatest part of the total radiation.

26. An apparatus as defined in claim 24, wherein the ozonizer is connected to means providing a normal voltage.

27. An apparatus as defined in claim 24, wherein the oxygen cylinder is fitted with a pressure-monitoring system.

28. An apparatus as defined in claim 24, wherein an oxygen generator is used in place of an oxygen cylinder.

29. An apparatus as defined in claim 24, further including an electrical circuit which comprises a master switch, a processing switch, and switches for the infrared lamp, the ultraviolet lamps and the ozonizer, and

7

8

wherein each of the switches can be operated independently.

30. An apparatus as defined in claim 29, wherein all the switches are so connected to each other that all the

switches are activated when the processing switch is turned on.

31. An apparatus as defined in claim 29, wherein a timer and/or a counter is/are connected to the processing switch.

\* \* \* \* \*

10

15

20

25

30

35

40

45

50

55

60

65



US005591457A

# United States Patent [19]

[11] Patent Number: **5,591,457**

Bolton

[45] Date of Patent: **Jan. 7, 1997**

[54] **METHOD OF INHIBITING THE AGGREGATION OF BLOOD PLATELETS AND STIMULATING THE IMMUNE SYSTEMS OF A HUMAN**

[75] Inventor: **Anthony E. Bolton**, Sheffield, England

[73] Assignee: **Vasogen Inc**, Etobicoke, Canada

[21] Appl. No.: **352,802**

[22] Filed: **Dec. 1, 1994**

### Related U.S. Application Data

[63] Continuation of Ser. No. 941,327, Sep. 4, 1992, abandoned, which is a continuation-in-part of Ser. No. 832,798, Feb. 7, 1992, abandoned.

[51] Int. Cl.<sup>6</sup> ..... **A01N 1/00; A61K 33/00; A61L 2/10**

[52] U.S. Cl. .... **424/613; 424/810; 514/929; 422/24; 422/44; 422/45; 422/46; 604/4; 435/2**

[58] Field of Search ..... **424/613, 810; 422/45, 24, 44, 46; 250/493.1; 604/4; 514/929; 435/2**

### [56] References Cited

#### U.S. PATENT DOCUMENTS

695,657	3/1902	Smith	604/25
3,715,430	2/1973	Ryan	424/127
3,925,344	12/1975	Mazur	530/385
4,061,736	12/1977	Morris et al.	514/6
4,473,496	9/1984	Scannon	530/385
4,500,534	2/1985	Frehel et al.	514/301
4,529,719	7/1985	Tye	514/6
4,584,130	4/1986	Bucci et al.	530/385
4,600,531	7/1986	Walder	123/456
4,632,980	6/1990	Zee et al.	530/380
4,659,726	4/1987	Yoshino et al.	514/365
4,826,811	5/1989	Sehgal et al.	514/6
4,831,268	5/1989	Fisch et al.	250/432
4,857,636	8/1989	Hsia	530/385
4,968,483	11/1990	Mueller et al.	422/45
4,983,637	1/1991	Herman	514/724
5,028,588	7/1991	Hoffman et al.	514/6
5,052,382	10/1991	Wainwright	128/202
5,194,590	3/1993	Sehgal et al.	530/385
5,250,665	10/1993	Kluger et al.	530/385

#### OTHER PUBLICATIONS

Medline Abstract 91104111, abstracting: Petukhov, E. B. et al. "Correction of Blood Hyperviscosity . . ." *Grud Serochnosudistaia Khir*, (1990) (10), pp. 34-37.

Medline Abstract 90020932, abstracting: Petukhov, E. B. et al. "Decreased Activity of Lipid . . ." *Vestn Khir* (May 1989), vol. 142(5), pp. 36-39.

Medline Abstract 80130497, abstracting: Vella Briffa D. et al. "Inhibition of human blood platelet aggregation . . ." *Br. J. Dermatol.* (1979 Dec.), vol. 101(6), pp. 679-683.

Drug Facts and Comparisons, 1994 edition, published by Facts and Comparisons, St. Louis, see pp. 263-269.

Cecil Textbook of Medicine, 19th ed., published by W. B. Saunders Co., PA, 1992, pp. 253-269, 823, 1085, 1530-1534 and 2161.

Physicians' Desk Reference, 47th ed., published by Medical Economics Data, NJ, 1993, pp. 710 and 2408-2411.

Rook, Alain H. et al., "Treatment of Autoimmune Disease with Extracorporeal Photochemotherapy: progressive systemic sclerosis," *The Yale J. of Biology and Medicine*, vol. 62, No. 6, Nov./Dec. 1989, pp. 639-645.

Tattoni, G. et al., "Osservazioni sull'efficacia di un trattamento balneoterapico ozonizzato in pazienti affetti da vasculopatie periferiche," *Minerva Cardioangiologica*, vol. 25/9, 1977, pp. 745-748.

"Cloned and Expressed Nitric Oxide Synthase Structurally Resembles Cytochrome P-450 Reductase," *Nature*, Jun. 27, 1992, vol. 351, pp. 714-718.

*British Medical Journal*, vol. 296, Jan. 30, 1988, pp. 320-331, entitled "Secondary Prevention of Vascular Disease by Prolonged Antiplatelet Treatment".

"Ozone: Historical Review," published in *Biomedical Technology*, Dec. 16, 1991, p. 5.

"Biological Roles of Nitric Oxide," *Scientific American*, May 1992, pp. 68-77.

D. Baran et al (associates) "Technical Report and Clinical Update" Mueller Medical International Inc., Oakville, Ontario, Canada, Sep. 1990.

Primary Examiner—John Pak

Attorney, Agent, or Firm—Ridout & Maybee

### [57] ABSTRACT

A method of inhibiting the aggregation of blood platelets in a human, which comprises: (a) contacting from about 0.01 ml to about 400 ml of blood with a blood platelet aggregation-inhibiting effective amount of ozone gas and ultraviolet radiation; and (b) administering the blood treated in step (a) to a human. A method of stimulating the immune system, and of treating immune system disorders, by treating blood with ultraviolet radiation and ozone gas, followed by administering the treated blood to a human.

Also disclosed is a method of treating Raynaud's Disease by contacting about 0.01 ml to about 400 ml of human blood with a blood platelet aggregation-inhibiting effective amount of ozone gas in admixture with oxygen gas, and ultraviolet radiation, while maintained at a temperature in the range of from about 37° C. to about 43° C. for a period for about 0.5 minutes to about 10 minutes, and administering the blood so treated to a human patient with Raynaud's Disease.

**9 Claims, No Drawings**

**METHOD OF INHIBITING THE  
AGGREGATION OF BLOOD PLATELETS  
AND STIMULATING THE IMMUNE  
SYSTEMS OF A HUMAN**

**CROSS-REFERENCE TO RELATED  
APPLICATIONS**

This application is a continuation of U.S. patent application Ser. No. 07/941,327, filed Sep. 4, 1992, now abandoned; which is a continuation-in-part of U.S. patent application Ser. No. 07/832,798, filed Feb. 7, 1992, now abandoned, the entire disclosure of which is incorporated herein by reference.

**BACKGROUND OF THE INVENTION**

**1. Field of the Invention**

The present invention relates to a method of inhibiting blood platelet aggregation in humans, as well as to a method of therapeutically treating human disease conditions associated with blood platelet aggregation. The invention also pertains to a method of stimulating the immune system, and to a method of therapeutically treating immune system disorders.

**2. Description of the Prior Art**

Platelets are the smallest of the formed elements of the blood. Every cubic millimeter of blood contains about 250 million platelets, as compared with only a few thousand white cells. There are about a trillion platelets in the blood of an average human adult. Platelets are not cells, but are fragments of the giant bone-marrow cells called megakaryocytes. When a megakaryocyte matures, its cytoplasm breaks up, forming several thousand platelets. Platelets lack DNA and have little ability to synthesize proteins. When released into the blood, they circulate and die in about ten days. However, platelets do possess an active metabolism to supply their energy needs.

Because platelets contain a generous amount of contractile protein (actomyosin), they are prone to contract much as muscles do. This phenomenon explains the shrinkage of a fresh blood clot after it stands for only a few minutes. The shrinkage plays a role in forming a hemostatic plug when a blood vessel is cut. The primary function of platelets is that of forming blood clots. When a wound occurs, platelets are attracted to the site where they activate a substance (thrombin) which starts the clotting process. Thrombin, in addition to converting fibrinogen into fibrin, also makes the platelets sticky. Thus, when exposed to collagen and thrombin, the platelets aggregate to form a plug in the hole of an injured blood vessel.

Platelets not only tend to stick to one another, but to the walls of blood vessels as well. Because they promote clotting, platelets have a key role in the formation of thrombi. The dangerous consequences of thrombi are evident in many cardiovascular and cerebrovascular disorders.

In this regard, the precise function of blood platelets in various human disease states has recently become increasingly understood as advances in biochemistry permit the etiologies of diseases to be better understood.

For example, many attempts have been made to explain the process of atherogenesis, that is, the creation of plaque which narrows arteries and, of particular concern, the coronary arteries. Recently, there has been increasing interest in the possible role of platelets in atherosclerosis.

In addition, a number of disease states in humans are believed to be associated with an aggregation of platelets in the blood. These platelet aggregation associated conditions include: peripheral vascular disease; thrombotic diseases such as coronary thrombosis and pulmonary thrombosis; stroke; eclampsia and pre-eclampsia; and hypertension.

A study completed by the University of Oxford, England, and published in the British Medical Journal, Vol. 296, Jan. 30 1988, pages 320-331, entitled "Secondary Prevention of Vascular Disease by Prolonged Antiplatelet Treatment," suggests that therapies which inhibit platelet aggregation may be useful for treating occlusive vascular disease. The study utilized aspirin, sulphapyrazone, or aspirin and dipyridamole as the platelet aggregation inhibiting agents.

Unfortunately, long-term aspirin therapy may lead to severe gastrointestinal irritation and bleeding. Also, these and other known agents which inhibit platelet aggregation may have other undesirable side-effects that make them unsuitable for administration to patients who could benefit from such therapy. For pregnant women with pre-eclampsia or other platelet aggregation associated conditions, the administration of drugs may be undesirable in view of the potential effects of the same on the developing fetus.

It would therefore be desirable to provide a method of inhibiting blood platelet aggregation which overcomes the deficiencies of the prior art.

A separate body of prior art discloses various methods of using ozone gas to treat certain human diseases, wounds and infections:

U.S. Pat. No. 695,657 to Smith discloses a portable ozonizer for the treatment of wounds. The device includes an ozonizer housed in a glass jacket, one end of which receives an air-supply tube and other end of which functions as an outlet tube for the ozonized air. The device enables topical application of ozone gas, which is said to be used to treat suppurating or gangrenous surfaces.

U.S. Pat. No. 3,715,430 to Ryan relates to a method and apparatus for producing substantially pure oxygen having a controlled content of ozone and higher oxygen polymers. The purified oxygen gas is exposed to ultraviolet light in a wavelength of 2485 to 2537 angstrom units in order to produce 5 to 500 parts per million of ozone and higher oxygen polymers in the gas mixture. Ryan indicates that the gas produced in this manner is non-irritating to the human body and may be intravenously injected into the blood stream for therapeutic use.

U.S. Pat. No. 4,632,980 to Zee et al. discloses a method of freeing blood and blood components of enveloped viruses by contacting the blood or blood product in an aqueous medium with an enveloped virus inactivating amount of ozone. The treatment is carried out at a temperature of 4° to 37° C., and an ozone concentration of 1-100 ppm. The disclosed process is said to be useful for inactivating the hepatitis virus, HTLV-I, -II, and -III, and influenza virus.

U.S. Pat. No. 4,831,268 to Fisch et al. provides a method for the radiation of corporeal blood to prevent arteriosclerosis related heart and vascular diseases caused by disturbances in the fat exchange. The disclosed process involves irradiating the blood in a blood conducting tube with radiation having an intensity of from about 1 mWcm<sup>-2</sup> to 10 mWcm<sup>-2</sup> in a wavelength range of from about 320 nm to 600 nm.

U.S. Pat. No. 4,968,483 to Müller et al. discloses an apparatus for the production of oxygenated blood. The apparatus includes a vessel for containing the blood to be processed, an ultraviolet lamp and infrared lamp associated

with the vessel, and a feed pipe extending into the vessel to a position near the bottom of the vessel, in which the feed pipe is connected to a source of ozone.

U.S. Pat. No. 4,983,637 to Herman relates to a method of treating systemic viral infections by the parenteral administration of pharmacologically effective amounts of oxonides of terpenes in pharmaceutically acceptable carriers. The disclosed method is particularly directed to the treatment of HIV infections.

U.S. Pat. No. 5,052,382 to Wainwright discloses an apparatus for the controlled generation and administration of ozone. The apparatus includes a generator for generating ozone, a monitor for monitoring the ozone production, a dosage device for providing a predetermined amount of ozone administration, and a computer control device for controlling the operation of the apparatus. The patent further discloses that administration of ozone to patients is known for the treatment of viral and bacterial infections, as well as for the treatment of external sores and wounds.

### SUMMARY OF THE INVENTION

Applicant has discovered that the aggregation of blood platelets in a human may be inhibited by contacting from about 0.01 ml to about 400 ml of blood from a human with a blood platelet aggregation-inhibiting effective amount of ozone gas and ultraviolet radiation, followed by administering the treated blood to a human.

The method of the invention is contemplated to be useful in treating a variety of conditions in humans which are associated with blood platelet aggregation such as arterial occlusive diseases, including peripheral vascular disease; thrombotic diseases, such as coronary thrombosis, pulmonary thrombosis, arterial thrombosis, and venous thrombosis; circulatory disorders, such as Raynaud's disease; stroke; pre-eclampsia; and hypertension.

The method of the invention increases blood levels of nitric oxide, which may partly explain the effect of inhibiting platelet aggregation achieved by the invention. Additionally, treatment of blood with ultraviolet radiation and ozone gas according to the invention has been found to increase blood levels of prostacyclin, a substance which is known to inhibit platelet aggregation and relax peripheral blood vessels.

The inventive method of treating blood has also been unexpectedly found to activate the human immune system by stimulating T-lymphocytes and monocytes, and by increasing the potential of peripheral blood mononuclear cells to proliferate. Thus, the invention also contemplates a method of treating immune system disorders by contacting from about 0.01 ml to about 400 ml of blood from a human with an immune system-stimulating effective amount of ozone gas and ultraviolet radiation, followed by administering the treated blood to a human.

### DETAILED DESCRIPTION OF THE INVENTION

The present invention provides a method of inhibiting the aggregation of blood platelets in a human, which comprises:

(a) contacting from about 0.01 ml to about 400 ml of blood with a blood platelet aggregation-inhibiting effective amount of ozone gas and ultraviolet radiation; and

(b) administering the blood treated in step (a) to a human.

As evidenced by the data set forth in Examples 1 and 2 below, Applicant has found that satisfactory inhibition of

platelet aggregation can only be achieved when the blood is treated with a combination of ozone gas and ultraviolet radiation. Treatment of blood solely with ozone gas produces minimal inhibition of blood platelet aggregation. Moreover, treatment of blood solely with ultraviolet light produces no inhibition of platelet aggregation whatsoever.

The combined treatment with ozone gas and ultraviolet light, however, has unexpectedly been found to produce significant inhibition of blood platelet aggregation, which may be useful in treating a variety of disorders associated with blood platelet aggregation.

The term "aggregation of blood platelets" as used herein refers to the sticking together of platelets to other platelets and/or to the walls of a blood vessel.

The ozone gas may be provided by any conventional source known in the art, such as an ozonizer. The ozone gas used in connection with the inventive method has a concentration of ozone of from about 0.5 µg/ml to about 100 µg/ml. Preferably, the ozone gas has a concentration of from about 5 µg/ml to about 50 µg/ml. The ozone gas is preferably delivered to the blood by means of a medical oxygen carrier; the ozone gas is preferably contacted with the blood by any means known in the art, preferably by bubbling the ozone/oxygen mixture through the blood sample.

The ultraviolet radiation may be provided by any conventional source known in the art, for example by a plurality of low-pressure ultraviolet lamps. The invention preferably utilizes a standard UV-C source of ultraviolet radiation. Preferably employed are low-pressure ultraviolet lamps that generate a line spectrum wherein at least about 90% of the radiation has a wavelength of about 253.7 nm. It is believed that ultraviolet radiation having emission wavelengths corresponding to standard UV-A and UV-B sources would also provide acceptable results.

The blood to be treated with UV/ozone is preferably heated to a temperature of from about 0° C. to about 56° C. while being contacted with the ozone gas and ultraviolet radiation. Any suitable source of heat known in the art may be employed to heat the blood, preferably one or more infrared lamps. The blood may be heated to about 37°-43° C., most preferably about 42.5° C. prior to being contacted with the ozone gas and ultraviolet radiation. Preferably, the temperature of the blood is then maintained at about 42.5° C. during the treatment with UV/ozone.

Alternatively, the blood sample is heated while being subjected to UV radiation, until the blood reaches a predetermined temperature (preferably about 42.5° C.), at which point bubbling of ozone gas through the blood is commenced. The concurrent UV/ozone treatment is then maintained for a predetermined period of time, preferably about 3 minutes.

Another alternative method involves subjecting the blood to UV/ozone while heating to a predetermined temperature (preferably about 42.5° C.), then either ending the treatment once the predetermined temperature is reached, or continuing UV/ozone treatment for a further period of time, most preferably about 3 minutes.

Heating the blood to about 42.5° C. with the infrared lamps preferably employed according to the invention has been found to take from about one minute and fifty seconds to about two minutes and ten seconds.

It will be understood that the source of blood treated according to the invention may be blood from an outside source, such as a blood donor of compatible blood type, which is treated with UV/ozone and then administered to a patient. Alternately, and preferably, the blood to be treated may be withdrawn from the human patient as an aliquot,



treated with UV/ozone, then readministered to the patient from whom the aliquot of blood was taken. All or a portion of the blood removed from the patient may be treated and then readministered to the patient.

In general, from about 0.01 ml to about 400 ml of blood may be treated according to the invention. Preferred amounts are in the range of about 0.1 ml to 200 ml, and more preferably from about 1 ml to 50 ml of blood. The method most preferably involves treating about 10 ml of blood with ozone gas and ultraviolet radiation, then administering (or readministering) the treated blood to the patient by intramuscular injection.

Other conventional techniques known in the art for administering blood may be employed, such as inter-arterial injection, intravenous injection, subcutaneous injection, and intraperitoneal injection. The administration of small volumes of host blood in this fashion is termed micro-auto-hemotherapy.

The invention also contemplates an embodiment wherein blood is continuously removed from a patient's body and circulated through an apparatus which treats the blood with ozone gas and ultraviolet light as described above, before returning the blood to the patient. This procedure would have particular utility, for example, during the performance of operative procedures, such as coronary bypass surgery.

The blood is contacted with the ozone gas and ultraviolet radiation for a period of time sufficient to effectively inhibit the aggregation of blood platelets. A treatment period of from a few seconds to about 60 minutes, preferably from about 0.5 minutes to about 10 minutes, and most preferably about 3 minutes, has been found to provide satisfactory inhibition of platelet aggregation. The blood is preferably maintained at a temperature of about 42.5° C. during the three minute treatment period.

The method should be carried out under sterile conditions known to those of ordinary skill in the art.

The method of the invention may be carried out using conventional apparatus for ozonating blood and irradiating blood with ultraviolet light known to those skilled in the medical art. Preferably, an apparatus similar to that disclosed in U.S. Pat. No. 4,968,483 is employed to carry out the method of the invention. The disclosure of U.S. Pat. No. 4,968,483 is incorporated herein in its entirety by reference.

In a preferred aspect of the invention, a method of inhibiting the aggregation of blood platelets in a human is provided, which comprises:

- (a) contacting from about 0.01 ml to about 400 ml of blood from a human with a blood platelet aggregation-inhibiting effective amount of from about 5 µg/ml to about 50 µg/ml of ozone gas and ultraviolet radiation having a wavelength of about 253.7 nm, while maintaining the blood at a temperature of from about 37° C. to about 43° C.; and

- (b) administering the blood treated in step (a) to a human.

The invention also contemplates a method of treating a condition in a human associated with blood platelet aggregation, by contacting about 0.01 ml to about 400 ml of blood from a human with a blood platelet aggregation-inhibiting effective amount of ozone gas and ultraviolet radiation, followed by administering the treated blood to a human.

The useful and preferred ranges of ozone concentration, ultraviolet wavelength, temperature, and other parameters of the method of treatment are the same as described above with regard to the method of inhibiting blood platelet aggregation.

Those skilled in the art will appreciate that the method of inhibiting blood platelet aggregation provided by the inven-

tion will have therapeutic utility for treating a wide range of disease states associated with the aggregation of blood platelets in humans.

The term "treating" as used herein refers to the alleviation or prevention of a particular disorder. In the case of traumatic conditions such as stroke, preventative treatment is obviously preferred. Also, although the term "human" is used to describe the preferred host, those skilled in the art will appreciate that the methods of the invention would have similar utility with other mammals.

The following diseases are illustrative of known conditions which may be associated with the aggregation of blood platelets, and which are treatable according to the inventive method: arterial occlusive diseases including peripheral vascular disease; arterial and venous disorders including thrombotic diseases such as coronary thrombosis, pulmonary thrombosis, arterial thrombosis, and venous thrombosis; circulatory disorders, such as Raynaud's disease; stroke; pre-eclampsia; and hypertension. This list is merely illustrative of conditions which are associated with platelet aggregation; those of ordinary skill in the art will appreciate that other disease states associated with an aggregation of blood platelets may be treated with the inventive technique.

With regard to peripheral vascular disease, the disease could theoretically be explained by a reduction of endothelial-derived relaxing factor (EDRF), low levels of which lead to a contraction of the smooth muscle of blood vessels, and hence a reduction in the diameter of the lumen of the vessel and a reduction in blood flow. The major naturally occurring EDRF is nitric oxide. In addition, nitric oxide stabilizes blood platelets, reducing their aggregation. An increase in EDRF (nitric oxide) levels, therefore, has a double beneficial effect on the circulatory system: it inhibits aggregation of platelets, making the blood more fluid, and it enlarges the diameter of the vessels, improving the flow.

As illustrated in Example 2 below, the method of the invention is believed to increase nitric oxide levels in the blood, which may explain one mode of action in the inventive treatment of peripheral vascular disease and other conditions associated with blood platelet aggregation.

Pre-eclampsia may lead to eclampsia, an acute hypertensive crisis that may occur in the second or third trimester of pregnancy. Although the precise etiology is unknown, overactive platelet activity leading to the formation of thrombi in the placenta is believed to be a cause of the condition. The inventive method, which results in a stabilization of the patient's blood platelets and an inhibition of platelet aggregation, is therefore a potential treatment modality. In particular, the method of the invention may be preferred over conventional antiplatelet therapeutics, where the administration of drugs to the mother is contraindicated.

Example 3 below shows that the method of the invention increases the blood concentration of 6-keto prostaglandin-F1-alpha, the stable metabolite of prostacyclin which is used to measure prostacyclin levels. Prostacyclin is a substance produced by platelets which inhibits platelet aggregation and relaxes peripheral blood vessels. The increase in prostacyclin levels provided by the invention thus appears to be another mechanism whereby the method is effective for treating peripheral vascular disease, and the other disclosed conditions associated with platelet aggregation.

Prostacyclin has in the past been used as an experimental treatment for Raynaud's disease, which is a severe form of circulatory disorder affecting the extremities. Prostacyclin, however, is too unstable and expensive to be a commercially practicable therapeutic agent. The method of the invention therefore provides a more satisfactory means for treating

circulatory diseases, such as Raynaud's disease, which are benefitted by an increase in blood levels of prostacyclin.

Examples 4 and 5 below support the finding that the method of treating blood according to the invention has an immune-stimulatory effect. In particular, treatment of blood with UV/ozone has been found to increase the proliferation of peripheral blood mononuclear cells after stimulation with Interleukin-2 (IL-2) (see Example 4), and also to stimulate T-lymphocytes and monocytes (see Example 5).

Thus, the invention also provides a method of stimulating or activating the immune system in a human by contacting about 0.01 ml to about 400 ml of blood from a human with an immune system-stimulating effective amount of ozone gas and ultraviolet radiation, followed by administering the treated blood to a human. Similarly, the invention contemplates a method of treating an immune system disorder in a human, by contacting about 0.01 ml to about 400 ml of blood from a human with an immune system-stimulating effective amount of ozone gas and ultraviolet radiation, followed by administering the treated blood to a human.

The useful and preferred ranges of ozone concentration, ultraviolet wavelength, temperature, and other parameters of these methods of treatment are the same as described above with regard to the method of inhibiting blood platelet aggregation.

The immune system disorders which may be treated by this method include allergic conditions, autoimmune conditions, and inflammatory conditions. Specific immune system disorders which may be treated according to the invention include arthritis, rheumatoid arthritis, asthma, graft-versus-host disease, diabetes mellitus, organ rejection, miscarriage, osteoarthritis, systemic lupus erythematosus, atopic allergy, multiple sclerosis, allergic dermatitis, inflammatory bowel disease, psoriasis, sarcoidosis, and other inflammatory disorders.

Further, the immune system disorder to be treated according to the present invention may be a lymphoproliferative disorder, such as malignant non-Hodgkin's lymphoma, Hodgkin's disease, or malignant histiocytosis. Also, the immune system disorder may be a neoplastic disorder, such as a leukemia.

The discoveries of the present invention may also be applied to treat inflammatory and autoimmune diseases, and may be applied to treat autoimmune diseases manifested by infertility. The immune system disorder to be treated may be a disorder resulting from the presence in a human of the virus which causes acquired immunodeficiency syndrome (AIDS).

More generally, the treatment of an "immune system disorder" is contemplated to mean the treatment of any disease that is associated with a reduced activity of the immune system, or which may be benefitted by increasing the activity of the immune system. Thus, the process of the invention may find applicability in the treatment of a variety of infectious diseases, particularly viral infections such as the HIV virus, tumors, bacterial, yeast or protozoal infections, and the like.

The following examples are given to illustrate the invention but are not deemed to be limiting thereof.

## EXAMPLE 1

### Inhibition of Blood Platelet Aggregation

The following experiment was conducted to study the effects of ozone/ultraviolet light treatment on blood platelet activity.

#### Experimental Procedure

Samples (20 ml) of peripheral blood were taken from 10 individuals for 13 separate experiments. Each sample was divided into two aliquots. The first aliquot was treated according to the inventive technique, as follows:

The 10 ml aliquot was treated in vitro for three minutes with ozone gas (variable ozone concentration of 5-50  $\mu\text{g/ml}$ ) and ultraviolet light (253.7 nm), at a temperature of 42.5° C. An apparatus similar to that disclosed in U.S. Pat. No. 4,968,483 was utilized to carry out the treatment of the blood sample.

The second 10 ml aliquot from each sample served as an untreated control.

Platelets were isolated from the control or treated samples by centrifugation, and their ability to aggregate in response to different concentrations of ADP (a natural platelet stimulator) was measured in an aggregometer. A sample of both ozone-treated and untreated blood was used for quantitation of platelet numbers, using a Coulter counter. In some of the experiments described below, aliquots of the blood were treated with different concentrations of ozone. In other experiments performed, the blood was treated in the presence and absence of UV-light irradiation.

Platelet aggregation in the ozone-treated blood was expressed as a percentage of aggregation in the same-person untreated control blood.

#### Results

As shown in Table 1, the results of the experiments indicate that treatment of blood with ozone and ultraviolet light according to the invention inhibits the aggregation of blood platelets. Furthermore, there is an indication that this inhibition is dose related to the ozone concentration (see Table 2).

#### The effect of high levels of ozone on ADP-stimulated blood platelets

High levels of ozone (between 35 and 50  $\mu\text{g/ml}$ ) caused a measurable inhibition of ADP-induced platelet aggregation (arbitrarily taken as 33.3% inhibition) in 11 of the 13 experiments (8 of the 10 individuals). Taking all the data on all 10 individuals, the mean inhibition of platelet aggregation was  $49.2 \pm 27.8\%$  (mean  $\pm$ sd). There was no significant difference between the inhibitory effects on blood taken from males and females (mean inhibition 48.1% and 50.7%, respectively).

This inhibition appears to relate to the concentration of ADP (aggregation stimulator) over the concentration range of 0.01-0.1 mM ADP, with lower inhibition at higher concentration of platelet agonist. However, this relationship did not hold at higher ADP concentrations (Table 1) and could be spurious, although the level of inhibition at 0.01 mM ADP is significantly greater than at 0.1 mM ADP (71% vs. 95%,  $p < 0.02$ ).

TABLE 1

The effect of high levels of ozone on the aggregation of human blood platelets in the presence of varying concentrations of ADP

Date (Individual)	Concentration of ozone ( $\mu\text{g/ml}$ )	Concentration of ADP (mM)	Percent Inhibition of Aggregation	Platelet Count	
				Before Ozone/UV	After Ozone/UV
21.11.91 (F1)	50	10	100		
27.11.91 (M1)	50	5	83.3		
		10	71.4		
		30	75.0		
2.12.91 (F2)	50	10	0		
		30	10.0		
		100	27.3		
		0.5	67.1		
3.12.91 (M2)	50	1	57.1		
		5	50.0		
		30	88.1		
		0.1	0	34	49
6.12.91 (M3)	50	0.1	6.2		
		0.5	4.0		
		0.5	0		
		0.05	67.0	46	93
11.12.91 (M4)	50	0.1	62.4		
		1.0	74.3		
		10.0	50.0		
		0.01	67.0	51	121
12.12.91 (M5)	50	0.1	7.1		
		1.0	35.7		
13.12.91 (F1)	50	0.01	63.4	33	87
		0.05	22.7		
		0.1	30.4		
		0.5	15.4		
		1.0	20.8		
		5.0	20.0		
		10.0	27.6		
		0.01	34.2	34	40
9.01.92 (M6)	50	0.05	31.0		
		0.1	9.8		
		0.5	15.4		
		1.0	26.2		
		5.0	31.3		
		0.001	71.4	49	64
10.01.92 (F3)	50	0.005	37.5		
		0.01	69.8		
		0.05	33.8		
		0.1	31.2		
		0.5	10.1		
		1.0	21.8		
13.01.92 (F4)	50	0.005	100	49	52
		0.01	100		
		0.05	95.2		
		0.1	92.8		
		0.5	95.9		
		1.0	91.6		
		5.0	95.8		
15.01.92 (F1)	40	0.01	80.0	81	66
		0.05	90.0		
		0.1	71.4		
		0.5	40.7		
		0.5	87.0		
		1.0	81.8		
		5.0	95.5		
		10.0	85.2		
		50.0	84.0		
21.01.92 (M2)	35	0.01	79.1	68	79

The following is a summary of the data set forth in Table 1:

TABLE 1

ADP mM	0.01	0.05	0.10	0.50	1.00	5.00	10.0
% inhibition of aggregation	70.8 +/-	53.5 +/-	34.7 +/-	37.6 +/-	50.3 +/-	60.7 +/-	60.7 +/-
N=	6	6	8	7	7	4	4

The effect of high levels of ozone on total whole blood platelet counts

As any apparent reduction in platelet aggregation following ozone treatment of whole blood could be caused by a loss of platelets from the blood during treatment, total whole platelet counts were performed on the treated and untreated whole blood samples in 9 experiments on blood from 8 individuals. Overall, the platelet count was 115.5±59.8% of the untreated level following ozonization (range 82-264%).

Thus, the total platelet counts before and after ozone/UV treatment do not indicate a major loss of platelets from the blood as a result of ozonization.

The effect of different concentrations of ozone on the inhibition of aggregation of human blood platelets stimulated with ADP

Three different concentrations of ozone (5, 25, and 50 µg/ml) were used at a range of ADP concentrations in 4 experiments on 4 different individuals. Bulking the data for

10 different ozone concentrations from each individual and calculating the mean for the data from the 4 experiments indicated that there was some dose response relationship between the concentration of ozone used and the inhibition of platelet aggregation (see Table 2). Although overall these differences were not significant, in two of the four individuals there was a significantly greater inhibitory effect of ozone at 50 µg/ml then at 5 µg/ml (see Table 3).

TABLE 2

The effect of different concentrations of ozone on inhibition of platelet aggregation in the presence of ADP

Date (Individual)	Concentration of ozone (µg/ml)	Concentration of ADP (mM)	Percent Inhibition of Aggregation	Platelet Count	
				Before Ozone/UV	After Ozone/UV
3.12.91 (M2)	5	0.1	27.3		
	25	0.1	100		
	5	0.5	0		
	25	0.5			
	50	0.5	67.1		
	5	1.0	0		
	25	1.0	28.6		
	50	1.0	57.1		
	5	5.0	0		
	25	5.0	25.0		
	50	5.0	50.0		
	5	30.0	50.0		
	25	30.0	62.0		
	50	30.0	88.1		
	9.01.92 (M6)	5	0.01	20.1	34
25		0.01	28.9		45
50		0.01	34.2		40
5		0.05	0		
25		0.05	5.2		
50		0.05	31.0		
5		0.1	9.8		
25		0.1	1.4		
50		0.1	9.8		
5		0.5	0		
25		0.5	0		
50		0.5	15.4		
5		1.0	22.5		
25		1.0	13.7		
50		1.0	26.2		
5	5.0	0			
25	5.0	17.8			
50	5.0	31.5			
10.01.92 (F3)	5	0.001	57.1	49	73
	25	0.001	85.7		90

TABLE 2-continued

The effect of different concentrations of ozone on inhibition of platelet aggregation in the presence of ADP

Date (Individual)	Concentration of ozone (µg/ml)	Concentration of ADP (mM)	Percent Inhibition of Aggregation	Platelet Count Before Ozone/UV-After Ozone/UV	
	50	0.001	71.4		64
	5	0.005	37.5		
	25	0.005	80.0		
	50	0.005	37.5		
	5	0.01	66.4		
	25	0.01	83.2		
	50	0.01	69.8		
	5	0.05	44.9		
	25	0.05	66.9		
	50	0.05	33.8		
	5	0.1	29.3		
	25	0.1	61.0		
	50	0.1	31.2		
	5	0.5	39.4		
	25	0.5	54.5		
	50	0.5	10.1		
	5	1.0	21.8		
	25	1.0	52.9		
	50	1.0	21.8		
13.01.92 (F4)	5	0.005	100	49	60
	25	0.005	100		85
	50	0.005	100		52
	5	0.01	100		
	25	0.01	87.5		
	50	0.01	100		
	5	0.05	84.8		
	25	0.05	97.1		
	50	0.05	95.2		
	5	0.1	82.9		
	25	0.1	91.4		
	50	0.1	92.9		
	5	0.5	83.3		
	25	0.5	95.8		
	50	0.5	95.8		
	5	1.0	83.2		
	25	1.0	89.5		
	50	1.0	91.6		
	5	5.0	79.2		
	25	5.0	91.7		
	50	5.0	95.8		
	5	10.0	85.3		
	25	10.0	80.0		
	50	10.0	80.0		

45

The following is a summary of the data set forth in Table 2:

Concentration of ozone (µg/ml)	5	25	50
Platelet aggregation (%) (mean ± sd, n = 4)	38.5 ± 1.2	56.5 ± 1.2	55.9 ± 1.2
	30.9	29.4	26.4

TABLE 3

The effect of different concentrations of ozone on inhibition of platelet aggregation in two individuals

Concentration of ozone (µg/ml)	5	25	50
Platelet aggregation M2 (%)	15.5 ± 1.2	53.9 ± 1.2	65.6 ± 1.2
Difference from 5 µg/ml	20.2	30.0	14.4
Platelet aggregation M6	8.7 ± 1.2	11.2 ± 1.2	24.7 ± 1.2
		ns	p < 0.01

50

TABLE 3-continued

The effect of different concentrations of ozone on inhibition of platelet aggregation in two individuals

Concentration of ozone (µg/ml)	5	25	50
(%)	9.6	10.2	9.0
Difference from 5 µg/ml		ns	p < 0.02

55

ns = not significant

The effect of UV light on the response of platelets to ozone

60

The effect of ozone on the aggregation of human blood platelets was investigated at different concentrations of ADP, in the presence or absence of UV light. The results, shown in Table 4, indicate that, although there may be some platelet aggregation-inhibitory response to ozone alone, this is nearly always greater in the presence of UV light and the

65

## 15

effect of UV light was highly significant ( $p < 0.001$ ) in this single experiment. This result was also repeated in a second experiment, using a single concentration of ADP (0.01 mM). The results of this second experiment are set forth in Table 5.

TABLE 4

The effect of UV light on the inhibition of ADP-induced platelet aggregation by ozone at a concentration of 40 µg/ml. (Experiment date 15.01.92, individual F1)		
Concentration ADP (mM)	Inhibition of platelet aggregation (%)	
	+UV	-UV
0.01	90.0	60.0
0.05	71.4	0
0.1	40.7	40.7
0.5	87.0	0
1.0	81.8	0
5.0	95.5	19.4
10.0	85.2	18.5
50.0	84.0	16.0
100.0	79.1	4.2
Mean $\pm$ sd	79.4 $\pm$ 15.1	17.6 $\pm$ 19.6 $p < 0.001$

TABLE 5

The effect of UV light on platelet aggregation induced by ADP (0.01 mM) in the presence or absence of ozone. (Experiment date 21.01.92, individual M2) Percent inhibition of platelet aggregation		
Ozone 35 µg/ml + UV	Ozone 35 µg/ml - UV	No ozone, UV alone
83.4%	11.2%	0%

In summary, the results of Example 1 indicate that the in vitro treatment of an aliquot of blood with ozone gas and ultraviolet light inhibits the aggregation of blood platelets. This platelet inhibition has been found to be dose related to the ozone concentration. Further, platelet inhibition was found to critically depend on the combined treatment of ultraviolet light and ozone gas, as evidenced in Tables 4 and 5. Treatment with ozone gas alone resulted in minimal inhibition of platelet aggregation, while treatment with ultraviolet light alone produced no inhibition of platelet aggregation.

## EXAMPLE 2

## Measurement of Nitric Oxide

In order to elucidate the mechanism whereby ozonization/UV light affects the aggregation of platelets in treated blood, the concentration of certain oxidized forms of nitrogen were measured.

The direct measurement of nitric oxide is difficult to achieve. However, nitric oxide is an intermediate in a metabolic pathway in which arginine is converted to citrulline. Other stable end-products are nitrates and nitrites.

Accordingly, the nitric oxide content for several samples of blood treated with ultraviolet light and ozone gas according to Example 1 were indirectly determined by measuring the combined nitrate plus nitrite concentrations in the samples before and after treatment with ozone/UV light, after converting nitrate to nitrite.

## 16

The results show that there is a small increase in nitrate plus nitric concentrations after treatment according to the invention. This increase was consistently found in samples treated with ozone gas/UV light. Thus, nitric oxide levels may be enhanced by the treatment with ozone gas/UV light, and this may be part of the mode of action by which an inhibition of blood platelet aggregation is achieved by the invention. This therapeutic effect would be consistent with the etiology of peripheral vascular disease described above.

## Conclusions

The data of Examples 1 and 2 suggest that the treatment of blood with ozone gas and ultraviolet light according to the invention is actually inducing an inhibition of platelet aggregation for the following reasons:

1. The inhibitory effect is at least partially dependent on the concentration of ADP, ozone being more inhibitory at lower ADP concentrations. This may be interpreted as the higher agonist concentrations partially overcoming the inhibitory effect of ozone by "hyperstimulating" the platelets. This suggests that the inhibition is at least partially reversible, and is probably not acting by destroying the platelet's ability to aggregate.
2. The inhibitory effect appears to be dose related to ozone concentration, with higher concentrations of ozone resulting in a greater inhibition of platelet aggregation.
3. The inhibitory effect is UV-dependent, suggesting that this is not a non-specific toxic effect caused by the oxidative capacity of the ozone gas.

## EXAMPLE 3

## Measurement of Prostacyclin

In order to assess the effect of treatment of blood with UV/ozone according to the invention on blood levels of prostacyclin, the concentration of its stable metabolic, 6-keto prostaglandin-F1-alpha, was measured.

Samples of blood from eight individuals were divided into two aliquots, one of which was treated with UV/ozone as described in Example 1, the other aliquot serving as an untreated control. The level of 6-keto prostaglandin-F1-alpha was then measured for each blood sample using standard techniques. The results are as follows:

Individual	Plasma 6-keto PGF1-alpha conc.		
	Control	Ozone/UV Treated	Percent Increase
1	2.0	4.6	230
2	1.7	8.8	518
3	1.2	5.7	475
4	0.6	2.7	450
5	2.7	6.7	248
6	2.3	2.0	87
7	2.6	4.0	154
8	3.1	8.0	258
		Mean	303%

Thus, in seven out of the eight individuals, treatment of their blood with UV/ozone resulted in an increase in the concentration of the prostacyclin metabolic, suggesting that this may be an additional mechanism whereby the treatment of the invention works to treat peripheral vascular disease and other diseases associated with blood platelet aggregation.

### Proliferation of Peripheral Blood Mononuclear Cells

This example illustrates the immune-stimulatory effect on blood which results from treatment of the blood with UV/ozone according to the invention.

Whole blood from four individuals was exposed to UV/ozone treatment as described in Example 1, using ozone concentrations ranging from about 35  $\mu\text{g/ml}$  to 50  $\mu\text{g/ml}$ . A parallel control of blood from the same person was treated with oxygen alone (no ozone/UV).

Peripheral blood mononuclear cells (PBMCs; a mixture of T-lymphocytes and monocytic cells) were isolated from each sample of blood by gradient density centrifugation. The isolated PBMCs were then cultured in the presence of Interleukin-2 as a stimulator. After three days of culture, the proliferation of the cells was assessed by measuring the incorporation of tritiated thymidine into the DNA of the dividing cells. The results are as follows:

Individual	Uptake of tritiated thymidine (cpm, mean $\pm$ sd)		Percent Stimulated by Ozone/UV
	Control	Ozone/UV Treated	
1	1433 $\pm$ 368	4195 $\pm$ 606	293
2	427 $\pm$ 111	1238 $\pm$ 166	290
	484 $\pm$ 88	1340 $\pm$ 165	277
3	299 $\pm$ 64	837 (mean of 2)	280
	437 (n = 2)	1351 (n = 2)	309
4	9102 $\pm$ 889	5311 $\pm$ 1601	58
	9485 $\pm$ 1483	5050 $\pm$ 1332	53

In conclusion, in three of the four individuals, treatment of their blood with UV/ozone according to the invention increased the proliferation of peripheral blood mononuclear cells after stimulation by Interleukin-2. Thus, the treatment of the invention has an immune-stimulatory effect on blood.

### EXAMPLE 5

#### Staining of Activation Markers

This example illustrates a second experimental approach which indicates that treatment of blood with UV/ozone according to the invention has an immune-stimulatory effect on human blood.

Samples of blood were separated into aliquots, in which one group of aliquots were treated with UV/ozone as described in Example 1, and the other group of samples were maintained as an untreated control. Each blood sample was then stained for certain activation markers of T-lymphocytes and monocytes, using conventional monoclonal antibody techniques. The proportion of the total cells which stained positive for the individual markers was quantitated by microscopy. The results are as follows:

Marker	Control	Ozone/UV Treated
CD25 (IL-2 receptor)	1%	26%
CD2 (E-rosette receptor)	3%	33%
HLA-DR (monocyte activation)	0%	2%

The above data for this example are all means of duplicates, and indicate that treatment with UV/ozone according to the invention results in the stimulation of T-lymphocytes and monocytes, further supporting the data in Example 4 above.

The invention being thus described, it will be obvious that the same may be varied in many ways. Such variations are not to be regarded as a departure from the spirit and scope of the invention, and all such modifications are intended to be included within the scope of the following claims.

What is claimed is:

1. A method of treating Raynaud's Disease in a human patient with Raynaud's Disease, which comprises: selecting an aliquot of from about 0.01 ml to about 400 ml of human blood of a type compatible with the blood of a human patient with Raynaud's Disease; contacting the selected blood aliquot simultaneously with a blood platelet aggregation-inhibiting effective amount of ozone gas in admixture with oxygen gas, and ultraviolet radiation, while maintained at a temperature in the range from about 37° C. to about 43° C. for a period for about 0.5 minutes to about 10 minutes; and administering the blood aliquot so treated to the human patient with Raynaud's Disease.
2. The method of claim 1 wherein the ozone gas is at a concentration of 0.5 micrograms per ml to about 100 micrograms per ml.
3. The method of claim 1 wherein the ozone gas is at a concentration from about 5 micrograms per ml to about 50 micrograms per ml.
4. The method of claim 1 wherein the ultraviolet radiation has a wavelength of about 253.7 nm.
5. The method of claim 1 wherein the blood aliquot is maintained at a temperature of about 42.5° C. while being contacted with the ozone gas in admixture with the oxygen gas, and ultraviolet radiation.
6. The method of claim 1 wherein the blood aliquot has a volume of about 10 ml.
7. The method of claim 1 wherein time blood aliquot is contacted with the ozone gas in admixture with oxygen gas and ultraviolet radiation for a period of about 3 minutes.
8. The method of claim 1 wherein the blood aliquot is administered to the human patient with Raynaud's Disease by a method selected from the group consisting of interarterial injection, intramuscular injection, intravenous injection, sub-cutaneous injection, and intraperitoneal injection.
9. The method of claim 1 wherein the blood aliquot is obtained by removing the blood aliquot from the same human to whom the blood is administered after treatment of the blood aliquot.

\* \* \* \* \*



## INTERNATIONAL APPLICATION PUBLISHED UNDER THE PATENT COOPERATION TREATY (PCT)

<p>(51) International Patent Classification <sup>6</sup> : <b>A61K 35/14</b></p>	<p><b>A1</b></p>	<p>(11) International Publication Number: <b>WO 98/07436</b> (43) International Publication Date: 26 February 1998 (26.02.98)</p>
<p>(21) International Application Number: PCT/CA97/00564 (22) International Filing Date: 11 August 1997 (11.08.97) (30) Priority Data: 9617611.0 22 August 1996 (22.08.96) GB 08/754,348 22 November 1996 (22.11.96) US (71) Applicant: VASOGEN INC. [CA/CA]; Unit 2, 108 Woodbine Downs Boulevard, Etobicoke, Ontario M9W 5S6 (CA). (72) Inventor: BOLTON, Anthony, E.; Ivy Cottage, Sherwood Road, Tideswell, Derbyshire SK17 8HS (GB). (74) Agents: HIRONS, Robert, G. et al.; Ridout &amp; Maybee, Suite 2400, One Queen Street East, Toronto, Ontario M5C 3B1 (CA).</p>	<p>(81) Designated States: AL, AM, AT, AU, AZ, BA, BB, BG, BR, BY, CA, CH, CN, CU, CZ, DE, DK, EE, ES, FI, GB, GE, GH, HU, IL, IS, JP, KE, KG, KP, KR, KZ, LK, LR, LS, LT, LU, LV, MD, MG, MK, MN, MW, MX, NO, NZ, PL, PT, RO, RU, SD, SE, SG, SI, SK, TJ, TM, TR, TT, UA, UG, UZ, VN, YU, ZW, ARIPO patent (GH, KE, LS, MW, SD, SZ, UG, ZW), Eurasian patent (AM, AZ, BY, KG, KZ, MD, RU, TJ, TM), European patent (AT, BE, CH, DE, DK, ES, FI, FR, GB, GR, IE, IT, LU, MC, NL, PT, SE), OAPI patent (BF, BJ, CF, CG, CI, CM, GA, GN, ML, MR, NE, SN, TD, TG).</p> <p><b>Published</b> <i>With international search report.</i></p>	
<p>(54) Title: TREATMENT OF AUTOIMMUNE DISEASES</p>		
<p>(57) Abstract</p> <p>An autoimmune vaccine is provided for administration to human patients to alleviate the symptoms of autoimmune diseases such as rheumatoid arthritis. The vaccine comprises an aliquot of the patient's blood, containing, <u>inter alia</u>, leukocytes having upregulated expression of various cell surface markers and lymphocytes containing decreased amounts of certain stress proteins. It is produced by subjecting the blood aliquot extracorporeally to certain stressors, namely oxidizing agents, UV radiation and elevated temperature.</p>		



**FOR THE PURPOSES OF INFORMATION ONLY**

Codes used to identify States party to the PCT on the front pages of pamphlets publishing international applications under the PCT.

AL	Albania	ES	Spain	LS	Lesotho	SI	Slovenia
AM	Armenia	FI	Finland	LT	Lithuania	SK	Slovakia
AT	Austria	FR	France	LU	Luxembourg	SN	Senegal
AU	Australia	GA	Gabon	LV	Latvia	SZ	Swaziland
AZ	Azerbaijan	GB	United Kingdom	MC	Monaco	TD	Chad
BA	Bosnia and Herzegovina	GE	Georgia	MD	Republic of Moldova	TG	Togo
BB	Barbados	GH	Ghana	MG	Madagascar	TJ	Tajikistan
BE	Belgium	GN	Guinea	MK	The former Yugoslav Republic of Macedonia	TM	Turkmenistan
BF	Burkina Faso	GR	Greece	ML	Mali	TR	Turkey
BG	Bulgaria	HU	Hungary	MN	Mongolia	TT	Trinidad and Tobago
BJ	Benin	IE	Ireland	MR	Mauritania	UA	Ukraine
BR	Brazil	IL	Israel	MW	Malawi	UG	Uganda
BY	Belarus	IS	Iceland	MX	Mexico	US	United States of America
CA	Canada	IT	Italy	NE	Niger	UZ	Uzbekistan
CF	Central African Republic	JP	Japan	NL	Netherlands	VN	Viet Nam
CG	Congo	KE	Kenya	NO	Norway	YU	Yugoslavia
CH	Switzerland	KG	Kyrgyzstan	NZ	New Zealand	ZW	Zimbabwe
CI	Côte d'Ivoire	KP	Democratic People's Republic of Korea	PL	Poland		
CM	Cameroon	KR	Republic of Korea	PT	Portugal		
CN	China	KZ	Kazakstan	RO	Romania		
CU	Cuba	LC	Saint Lucia	RU	Russian Federation		
CZ	Czech Republic	LJ	Liechtenstein	SD	Sudan		
DE	Germany	LK	Sri Lanka	SE	Sweden		
DK	Denmark	LR	Liberia	SG	Singapore		
EE	Estonia						

## TREATMENT OF AUTOIMMUNE DISEASES

### FIELD OF THE INVENTION

This invention relates to vaccines, their preparation and use in medical treatments. More particularly, it relates to treatments for alleviating autoimmune diseases and their symptoms, to a vaccine useful therein, and to processes for preparing and using such a vaccine.

### BACKGROUND OF THE INVENTION

Autoimmune diseases include rheumatoid arthritis, graft versus host disease, systemic lupus erythromatosis (SLE), scleroderma, multiple sclerosis, diabetes, inflammatory bowel disease, psoriasis, and other afflictions. Also, the rejection of transplanted organ is a process which has pathological similarities to autoimmune disease. Autoimmune diseases may be divided into two general types, namely connective tissue autoimmune diseases (exemplified by arthritis, lupus and scleroderma), and failures of specific organs (exemplified by multiple sclerosis, and diabetes).

In general terms, a normally functioning immune system distinguishes between the antigens of foreign invading organisms (non-self) and tissues native to its own body (self), so as to provide a defence against foreign organisms. Central to the proper functioning of the immune system, therefore, is the ability of the system to discriminate between self and non-self. When a patient's immune system fails to discriminate between self and non-self and starts to react against self antigens, then an autoimmune disorder arises.

- 2 -

The causes responsible for the reaction of an affected person's immune system against self are not fully understood, and several different theories have been put forward. The immune response to an antigen is triggered by the interaction of the antigen with receptors of predetermined specificity on certain lymphocytes. It is believed that, at an early stage in development of the immune system, those lymphocytes with receptors recognizing self antigens are recognized and eliminated from the body's system by a process of deletion. Alternatively, or in addition, such self-reactive lymphocytes may be controlled by the suppression of their activities. Both mechanisms probably occur.

The immune system of normal healthy individuals is able to identify and to react against a family of proteins which are highly conserved in nature (i.e. they have a similar structure throughout all living organisms). This family of proteins is called the stress or heat-shock proteins (HSP), and they are grouped according to their approximate molecular weights. Members of the HSP family include the HSP60 group, and, among others, proteins in the molecular weight range 50 to 100 kilodaltons. Increased production of HSP's was first identified as a response to heat stress, but this now appears to be part of a general response to a variety of cell stresses. HSPs are normally located within cells, and their function appears to be the stabilization of the structure of various proteins in stressed cells, so as to protect the cell from the protein denaturing effects of various stressors. However, it is likely that HSPs have a number of other functions which are, as yet, not fully understood. Heat shock proteins, HSP's, are discussed in some detail by William J. Welch, in an article in "Scientific American", May, 1993, page 56.

One group of the family of HSP's, the HSP 60 group, contains proteins which show about 50% identity

- 3 -

between bacterial cells and human cells. Infection with bacteria containing HSP 65 results in an immune response in healthy humans against the bacterial HSP65, evidenced by the production of anti-HSP65 antibodies. Thus, a healthy immune system appears to be able to identify and react against self-like antigens.

In certain pathologies, for example many autoimmune diseases such as rheumatoid arthritis and scleroderma, patients also show the presence of antibodies to HSP 65. In the past, this has led to conclusions that autoimmune diseases result from bacterial infection. Now it seems likely that autoimmune diseases can, at least in some cases, be associated with an inappropriate control of the autoimmune response. In other words, it is possible that the antibodies to HSP 65 result from an autoimmune reaction initiated against HSPs from the body itself, but one which has been improperly controlled. In such cases, therefore, it should be possible to control an inappropriate autoimmune response, by stimulating the body's natural immune control mechanisms, using a particular and specific method of vaccination.

To stimulate the body's immune response, a vaccine is required which will, upon injection into the host body, enable the host immune system to present the antigens contained in the vaccine to cells of the host immune system. Antigen presentation is performed by antigen presenting cells.

A vaccine to treat autoimmune diseases should contain antigens or fragments thereof (peptides) that will activate the body's immune control mechanisms. In addition, the antigens (peptides) should be present in a form which can be recognized by the host immune system when the vaccine is introduced into the host. Certain of the antigens may be present on intact cells. The objective of

- 4 -

such a vaccination is to activate regulatory immune pathways, particularly those controlling autoimmune responses, thereby downregulating the autoimmune response.

The particular antigens which will activate the control mechanisms of a mammalian autoimmune system are not fully understood. It is however recognized that they may include antigens derived from lymphocyte receptors, which may function to stimulate control mechanisms, to inhibit those lymphocytes which cause pathological autoimmune responses in the patient. They may also include HSPs, such as the HSP 60 group of proteins, and leucocyte surface molecules such as those of the Major Histocompatibility Complex (MHC) including MHC class 1 and class 2 molecules. MHC class 2 molecules function physiologically to present peptides to antigen-presenting cells as part of the immune response.

It is important that the lymphocyte receptors and other cell-derived molecules for vaccination of an autoimmune suffering patient be derived from cells obtained from the same patient, since this system will contain the autoimmune specificity required to stimulate an appropriate regulatory immune response. Receptors on other leucocytes in the blood may alternatively or additionally be important in the proposed vaccination process. The use of such a system as the basis of a vaccine may be considered analogous to the use of a particular viral antigen as a vaccine to treat and prevent disease caused by that virus. A vaccine for treating an autoimmune disease should, therefore, be prepared from a sample of the patient's own blood. Such a vaccine may be described as an autovaccine.

For antigens to be effective in stimulating (or inhibiting) the immune system, the antigens should be presented to immune cells of the host system by antigen-presenting cells, which are naturally present in the body.

- 5 -

Many of the antigen-presenting cells are phagocytes, which attach to the antigens, engulf them by phagocytosis, and break them down or process them. The preparation of such an autovaccine should include a process whereby the lymphocytes and other leucocytes in the vaccine, which may be a source of antigens, are in a form whereby they are likely to be phagocytosed by phagocytic antigen-presenting cells upon re-injection into the patient, so that the antigens or effective residues thereof are presented on the surface of an antigen-presenting cell. Then they can effect a controlling mechanism on the immune system, either inhibitory or stimulatory.

During the normal growth period of a mammalian body, tissues become reshaped with areas of cells being removed. This is accomplished by the cells' undergoing a process called programmed cell death or apoptosis, the apoptotic cells disintegrating and being phagocytosed while not releasing their contents.

U.S. Patent 4,968,483 Mueller et al. describes an apparatus for oxygenating blood, by treating an aliquot of a patient's blood, extracorporeally, with an oxygen/ozone mixture and ultraviolet light, at a controlled temperature. The apparatus is proposed for use in haematological oxidation therapy.

U.S. Patent 5,052,382 Wainwright discloses an apparatus for the controlled generation and administration of ozone. The apparatus includes a generator for generating ozone, a monitor for monitoring the ozone production, a dosage device for providing a predetermined amount of ozone administration, and a computer control device for controlling the operation of the apparatus. The patent further discloses that administration of ozone to patients is known for the treatment of viral and bacterial

- 6 -

infections, as well as for the treatment of external sores and wounds.

#### SUMMARY OF THE INVENTION

It is an object of the present invention to provide a novel autovaccine useful in the alleviation of symptoms of at least one autoimmune disease.

It is a further object of the present invention to provide a novel process for the preparation of such an autovaccine.

It is a further and more specific object of the present invention to provide a novel treatment for the alleviation of the symptoms of at least one autoimmune disease in a human patient suffering therefrom.

Accordingly, the present invention provides, from a first aspect, an autovaccine for treatment of an autoimmune disease in a mammalian patient, and derived from an aliquot of the autoimmune patient's own blood. The autovaccine is characterized by the presence therein, in comparison with the untreated, circulating blood of the autoimmune patient, of at least one of the following characterizing features:

- increased numbers of lymphocytes exhibiting a condensed apopincreased intra-cellular vacuolation as seen under electron microscopy and abnormally smooth surface topography as seen by scanning electron microscopy;
- a release of specific proteins from the cell surface of the blood leucocytes, including the MHC Class II molecule HLA-DR, resulting in a reduction in the number of cells expressing such surface proteins;

- 7 -

- an upregulation in the expression of certain cell surface markers for example CD-11b, a component of the ligand for the cell adhesion molecule ICAM-1;

- a decrease in the amount of heat shock protein HSP-60 contained in the leucocytes, particularly the lymphocytes, therein, and an increase in HSP-60 in the plasma;

- a decrease in HSP-70 within the lymphocytes;

- a decreased ability of the lymphocytes to proliferate in response to exogenous stimuli;

- a decreased ability of neutrophils to phagocytose and undergo the oxidative burst response.

There is an increase in the number of morphologically altered lymphocytes and other leucocytes in the autovaccine according to the invention. These cells may become preferentially phagocytosed upon re-injection into the host body.

There are a number of different phagocytic cell types present in the mammalian body, including various antigen presenting cells and neutrophils. In order to facilitate phagocytosis by antigen presenting cells rather than by other phagocytes, the lymphocytes and other leucocytes present in the autovaccine of the invention are treated so that they may interact preferentially with antigen presenting phagocytic cells. Cells adhere to each other by a number of mechanisms including the expression of cell adhesion molecules. Cell adhesion molecules present on one cell type interact with specific ligands for particular adhesion molecules present on the adhering cell type. The present invention may result in a preferential interaction of cells in the autovaccine to antigen presenting cells in the host body, by upregulation, on the surface of the cells in the autovaccine, of the expression of the ligand for adhesion molecules found on antigen-presenting cells in the host body. Antigen presenting



- 8 -

cells express a number of cell adhesion molecules, including ICAM-1, one of the ligands for which is CD-11b. One way by which the process of the invention may change the preferential phagocytosis of the morphologically altered cells is by upregulation of adhesion molecules including CD-11b.

The preparation of the autovaccine according to the present invention comprises extracting from the patient suffering from an autoimmune disease an aliquot of blood of volume about 0.01 ml to about 400 ml, and contacting the aliquot of blood, extracorporeally, with an immune system-stimulating effective amount of ozone gas and ultraviolet radiation. The aliquot of blood extracted from the patient has one or more features which characterize it as blood of a patient who has an autoimmune condition, and distinguish it from blood of normal, healthy individuals and from blood of patients suffering from other abnormalities and pathological conditions. These features include an increased erythrocyte sedimentation rate, an increased level of rheumatoid factor, an increased level of C-reactive protein, the presence of antibodies to HSP 65, and combinations of two or more of these factors. Other such factors characteristic of a specific autoimmune condition and therefore present in the blood of sufferers of that condition are known, and form the basis of standard diagnostic blood tests for the specific condition.

The treatment for the alleviation of the symptoms of at least one autoimmune disease in a human patient suffering therefrom, in accordance with the present invention, comprises extracting from the patient an aliquot of blood of volume about 0.001 ml to about 400 ml, contacting the aliquot of blood, extracorporeally, with an immune system-stimulating amount of ozone gas and ultraviolet radiation, followed by administering the treated blood aliquot to the human patient.

**BRIEF REFERENCE TO THE DRAWINGS**

The accompanying drawing Figure 1 is a graphical presentation of the results of Example 2 below.

**DESCRIPTION OF THE PREFERRED EMBODIMENTS**

When the autovaccine according to the present invention is injected into the autoimmune patient, significant alleviation of the patient's autoimmune condition is experienced, as set out in the specific embodiments of the invention described below. Exactly how the vaccine operates following this re-injection is not currently fully understood. The following tentative explanations are offered for a better and more complete description of the invention, but are not to be considered as binding or limiting.

T-cells, which are one kind of lymphocyte and which play a significant role in the control of the immune system, include CD-8 cells, further subdividable into suppressor cells and cytotoxic cells; and CD-4 cells otherwise known as T-helper cells, further subdividable into TH1 and TH2 cells. The TH1 cells secrete pro-inflammatory cytokines such as interferon gamma. The TH2 cells are considered to be regulatory cells and secrete regulatory cytokines, such as interleukin-4. In a normal, healthy individual, the ratio of TH1 cells to TH2 cells is around 3:1. In autoimmune conditions, there is usually an imbalance in the TH cell types, often with an increase in the TH1 cells compared to the TH2 cells, i.e. there is a change in the ratio between them, with a consequent development of an inflammatory condition often noted in autoimmune disease. A number of components of the autovaccine of the present invention, including HSP60 lost from within the lymphocytes to the plasma, HLA-DR and/or other MHC antigens released from the leucocyte cell

- 10 -

surfaces and perhaps also the increased expression of cell surface marker B7.2, may lead to an increase in, or upregulation of, the TH2 cells or a decrease in TH1 cells in the patient's blood. This shifts the balance towards increasing the secretion of regulatory cytokines, and/or upregulating the suppressor cells to stimulate an inhibitory pathway for the autoimmune disease and alleviate or even switch off the autoimmune response pathway.

It is also commonly accepted that while many people may have significant populations of autoreactive T-cells, in patients with auto-immune disease this is a feature in the control of these autoreactive cells and this is partly responsible for the autoimmune disease. The autoimmune disease suffering patient's ability to regulate these autoreactive T-cells is compromised. The autovaccine of the invention restores the system towards a normal immune state.

The autovaccine is prepared by exposing the blood aliquot to at least one stressor, in controlled amounts, the stressor being selected from among oxidizing agents such as ozone, ultraviolet radiation and elevated temperature, and combinations of two or more of such stressors. The resulting blood aliquot, after such treatment, serves as an autovaccine, and can be reinjected into the autoimmune patient. Following a course of such treatments, a patient's signs and symptoms of autoimmune disease such as those of rheumatoid arthritis, scleroderma and the like are markedly reduced. The subjective reports of alleviation of symptoms of rheumatoid arthritis are consistent with objective measurements of relative erythrocyte sedimentation rates, an objective test accepted as meaningful in measuring the progression of an autoimmune disease such as rheumatoid arthritis by the American College of Rheumatology.

- 11 -

In preparing the autovaccine according to the invention, by modification of a blood aliquot extracted from the patient, and having characteristics derived from the patient's autoimmune condition, the blood cells are stressed. This affects the heat shock proteins, HSP, contained in the cell. HSP-60 levels in the mononuclear cells are reduced, and are increased in the plasma. Further, the level of HSP-72 present in the mononuclear cells is reduced. Also as a result of the process of the invention, certain surface (membrane) proteins on the lymphocytes, for example HLA-DR, are reduced whereas others, such as CD-3, do not change and yet others such as CD-11b in neutrophils are upregulated. Accordingly it is apparently not a non-specific membrane change which is occurring, nor is it cell destruction. It is a complex active process.

Microscopic visualization of the autovaccine according to the present invention demonstrates cells with altered surface features and an increased degree of intracellular vacuolation. This suggests the presence in the autovaccine of increased numbers of morphologically altered cells which may be preferentially phagocytosed upon reinjection, for appropriate presentation of the antigens of the auto-immune disease.

In the preferred autovaccine in accordance with the present invention, the number of mononuclear cells or leucocytes exhibiting the presence of HSP-60 therein is decreased, as is the amount of HSP-60 in each cell, as compared with the normal, untreated peripheral blood of the source patient. Whereas the patient normally has, typically, about 30% of mononuclear cells exhibiting the presence of HSP-60 therein (as measured by whole blood intracellular flow cytometry), the autovaccine has only 12-20%. In experimental studies, it has been found that the figure reduces from 29.3% to 15.5%, mean of six tests.

- 12 -

Preferably also, the number of leucocytes exhibiting the presence of HSP-72, which is about 50% in the untreated blood of the source patient, is reduced to 25-35% in the autovaccine of the present invention. In experimental studies, this figure for HSP-72 reduced from 49.4% in untreated blood to 30.2% in the autovaccine, mean of six tests, similarly measured.

The number of cells which express the cell surface specific protein HLA-DR, in the preferred autovaccine of the present invention, is reduced as compared with the patient's untreated blood, possibly as a result of its release from the cell surface. Typically, the number of cells expressing HLA-DR reduces from about 23% to about 8-12%, as measured by whole blood flow cytometry. In experimental studies, this figure reduced from 23.3% to 10.3%, mean of five experiments.

The upregulation of the surface marker CD-11b in the preferred autovaccine of the present invention can be expressed as an increase in the percentage of neutrophils in the autovaccine which test positive for CD-11b, compared with the patient's source blood. Typically, the increase is from about 10% up to the approximate range 70-95%. In experimental studies, an increase from 10.3% to 84% was obtained, mean of six tests.

A significant feature of the present invention is that the source of the blood from which the autovaccine is prepared for a specific patient suffering from an autoimmune disease is the patient himself or herself. The patient's blood has characteristics derived from the autoimmune disease. The antigens forming the basis of the autovaccine find their origin in the patient's own blood. No extraneous antigens are added; the effective antigens are present in the patient's blood, and/or are released or modified by the process of preparing the autovaccine using

- 13 -

the patient's own blood as the source material. Moreover, in many cases, the precise autoimmune disease from which the patient suffers appears to be immaterial. The antigens for the autovaccine for the disease are present in, or are developed by treatment of, the patient's own blood.

Preferably, the stressors to which the leucocytes in the extracted blood aliquot are subjected are a temperature stress (blood temperature above body temperature), an oxidative environment, such as a mixture of ozone and oxygen bubbled through the blood aliquot, and ultraviolet radiation, simultaneously or successively, but preferably simultaneously.

The present invention provides a method of alleviating the symptoms of an autoimmune disease in a human, which comprises:

- (a) contacting of about 0.01 ml to about 400 ml of blood with an immune system modifying effective amount of ozone gas and ultraviolet radiation; and
- (b) administering the blood treated in step (a) to a human.

In general, from about 0.01 ml to about 400 ml of blood may be treated according to the invention. Preferred amounts are in the range of about 0.1 ml to 200 ml. More suitably, the aliquot for treatment has a volume of from about 0.1-100 mls, preferably 1-50 ml and most preferably 5-15 mls. The method most preferably involves treating an aliquot of about 10 mls of blood with ozone gas and ultraviolet radiation, then re-administering the treated blood to the patient by intramuscular injection.

As noted, it is preferred, according to the invention, to apply all three of the aforementioned

- 14 -

stressors simultaneously to the aliquot under treatment. Care must be taken not to utilize an excessive level of the stressors, to the extent that the cell membranes of the white cells are caused to be disrupted.

The temperature stressor must keep the aliquot in the liquid phase, i.e. from about 0°C to about 56°C and should not heat it above about 55°C. Any suitable source of heat known in the art may be employed to heat the blood, preferably one or more infrared lamps. Preferably the temperature stressor warms the aliquot being treated, to a temperature above normal body temperature, i.e. to about 37-55°C, and most preferably from about 37-43°C, e.g. about 42.5°C. Preferably the temperature of the blood aliquot is maintained at this elevated temperature during the treatment with UV/ozone.

Alternatively, the blood sample is heated while being subjected to UV radiation, until the blood reaches a predetermined temperature (preferably about 42.5°C), at which point bubbling of ozone gas through the blood is commenced. The concurrent UV/ozone treatment is then maintained for a predetermined period of time, preferably about 3 minutes.

Another alternative method involves subjecting the blood to UV/ozone while heating to a predetermined temperature (preferably about 42.5°C), then either ending the treatment once the predetermined temperature is reached, or continuing UV/ozone treatment for a further period of time, most preferably about 3 minutes.

The application of the oxidative stressor preferably involves exposing the aliquot to a mixture of medical grade oxygen and ozone gas, most preferably by bubbling through the aliquot, at the aforementioned temperature range, a stream of medical grade oxygen gas

- 15 -

having ozone as a minor component therein. The ozone gas may be provided by any conventional source known in the art. Suitably the gas stream has an ozone content of from about 1.0 - 100  $\mu\text{g/ml}$ , preferably 3 - 70  $\mu\text{g/ml}$ , and most preferably from about 5 - 50  $\mu\text{g/ml}$ . The gas stream is supplied to the aliquot at a rate of from about 0.01 - 2.0 litres per minute, preferably 0.1 - 1.0 litres per minute and most preferably at about 0.18 litres per minute (STP).

The ultraviolet radiation stressor is suitably applied by irradiating the aliquot under treatment from an appropriate source of UV radiation, while the aliquot is maintained at the aforementioned temperature and while the oxygen/ozone gaseous mixture is being bubbled through the aliquot. The ultraviolet radiation may be provided by any conventional source known in the art, for example by a plurality of low-pressure ultraviolet lamps. The method of the invention preferably utilizes a standard UV-C source of ultraviolet radiation, namely UV lamps emitting in the C-band wavelengths, i.e. at wavelengths shorter than about 280 nm. Ultraviolet radiation corresponding to standard UV-A and UV-B sources can also be used. Preferably employed are low-pressure ultraviolet lamps that generate a line spectrum wherein at least 90% of the radiation has a wavelength of about 253.7 nm. An appropriate dosage of such UV radiation, applied simultaneously with the aforementioned temperature and oxidative environment stressors, is obtained from lamps with a power output of from about 15 to about 25 watts, at the chosen UV wavelength, arranged to surround the sample container holding the aliquot, each lamp providing an intensity, at a distance of 1 meter, of from about 45 - 65 mW/sq.cm. Several such lamps surrounding the sample bottle, with a combined output at 253.7 nm of 15 - 25 watts, operated at maximum intensity, may advantageously be used. At the incident surface of the blood, the UV energy supplied is 0.2-0.25 Joules per  $\text{cm}^2$ . Such a treatment provides a blood



- 16 -

aliquot which is appropriately modified according to the invention to create the auto-vaccine outlined above ready for re-injection into the patient.

The time for which the aliquot is subjected to the stressors can be from a few seconds to about 60 minutes. It is normally within the time range of from about 0.5 - 60 minutes. This depends to some extent upon the chosen intensity of the UV irradiation, the temperature and the concentration of and rate at which the oxidizing agent is supplied to the aliquot. The more severe the stressors applied to the aliquot, generally the shorter time for which they need to be applied. Some experimentation to establish optimum times may be necessary on the part of the operator, once the other stressor levels have been set. Under most stressor conditions, preferred times will be in the approximate range of about 0.5 - 10 minutes, most preferably 2 - 5 minutes, and normally around 3 minutes. The starting blood temperature, and the rate at which it can be warmed or cooled to a predetermined temperature, tends to vary from patient to patient.

In the practice of the preferred process of the present invention, the blood aliquot (or the separated cellular fractions of the blood, or mixtures of the separated cells, including platelets, these various leucocyte-containing combinations, along with whole blood, being referred to collectively throughout as the "aliquot") may be treated with the stressors using an apparatus of the type described in U.S. patent 4,968,483 Mueller. The aliquot is placed in a suitable, sterile, UV-radiation-transmissive container, which is then fitted into the machine. The temperature of the aliquot is adjusted to the predetermined value, e.g. 42.5°C, by the use of a suitable heat source such as an IR lamp, and the UV lamps are switched on for a fixed period before the gas flow is applied to the aliquot providing the oxidative stress, to

- 17 -

allow the output of the UV lamps to stabilize. Then the oxygen/ozone gas mixture, of known composition and controlled flow rate, is applied to the aliquot, for the predetermined duration of 0.5 - 60 minutes, preferably 2-5 minutes and most preferably about 3 minutes as discussed above, so that the aliquot experiences all three stressors simultaneously. In this way, the blood aliquot is appropriately modified to produce an auto-vaccine according to the present invention sufficient to achieve the desired effects.

Example 4 below supports the finding that the method of treating blood according to the invention has an immune modifying effect. In particular, treatment of blood with UV/ozone has been found to increase the expression of activation markers on the surface of the lymphocytes and monocytes (see Example 4).

Thus, the invention also provides a method of modifying the immune system in a human by contacting about 0.01 ml to about 400 ml of blood from a human with an immune system-modifying effective amount of ozone gas and ultraviolet radiation, followed by administering the treated blood to a human. Similarly, the invention contemplates a method of treating an immune system disorder in a human, by contacting about 0.01 ml to about 400 ml of blood from a human with an immune system-modifying effective amount of ozone gas and ultraviolet radiation, followed by administering the treated blood to a human.

The immune system disorders which may be treated by this method include allergic conditions, autoimmune conditions, and inflammatory conditions. Specific immune system disorders which may be treated according to the invention include rheumatoid arthritis, scleroderma, graft-versus-host disease, diabetes mellitus, organ rejection, miscarriage, systemic lupus erythromatosis, multiple

- 18 -

sclerosis, inflammatory bowel disease, psoriasis, and other inflammatory disorders. The discoveries of the present invention may also be applied to treat autoimmune diseases manifested by infertility, including endometriosis.

The invention is further described for illustrative purposes with reference to specific examples of clinical use of it and objective and subjective results from such clinical uses.

#### EXAMPLE 1

Thirty patients with active rheumatoid arthritis, 21 females and 9 males, were treated by the preferred process according to the present invention. The age range of the patients was 26 - 72 years, with the mean age 52.2 years, at the start of the study. Each patient received between 30 and 60 individual treatments (mean 48.3 treatments) over a time span of 62 weeks (mean 20.6 weeks). Each individual treatment consisted of the removal of a 10 mL aliquot of blood, the treatment of the blood aliquot simultaneously with gaseous oxygen/ozone mixture and ultraviolet light at elevated temperature using an apparatus as generally described in the aforementioned U.S. Patent 4,968,483 Mueller et.al.

The constitution of the gas mixture was 14-15 mcg/mL ozone/medical grade oxygen. The gas mixture was fed through the aliquot at a rate of about 200 mLs/minute, for a period of 3 minutes. The temperature of the aliquot was held steady at 42.5°C. The UV radiation had a wavelength of 253.7 nm.

Post treatment measurements were conducted 1 day to nine months after the final treatment of each patient (mean 12.4 weeks). Blood samples were taken and analyzed for leucocytes, erythrocyte sedimentation rate, rheumatoid

factor and C-reactive protein, using standard test procedures. The erythrocyte sedimentation rate and C-reactive protein are elevated in most inflammatory conditions including rheumatoid arthritis, and Rheumatoid Factor is elevated in most cases of rheumatoid arthritis as well as in some cases of certain other auto-immune diseases. White blood cell count, erythrocyte sedimentation rate, rheumatoid factor and C-reactive protein all showed significant reduction after the course of treatment. Particularly noteworthy is the significant reduction in erythrocyte sedimentation rate, an indicator of rheumatoid arthritis improvement, accepted by the American College of Rheumatology.

In addition, patients were rated by medical personnel subjectively, for the apparent severity of their rheumatoid arthritis symptoms, before and after the courses of treatment, on a scale of 5 (very bad) to 1 (excellent). Again, a marked improvement in each case was reported.

The mean results and from paired t-tests comparing individuals' pre- and post-treatment levels, are given in the following Table.

**TABLE**

Clinical Measurements	Normal Ranges	(Pre-Treatment Mean $\pm$ SD)	Post-Treatment (Mean $\pm$ SD)	Paired T-test
Symptom Rating		3.9 $\pm$ 0.9	2.6 $\pm$ 0.6	p<0.0001
Leucocytes 10 <sup>9</sup> /L	4.0-10.0	11.68 $\pm$ 2.84	8.70 $\pm$ 1.02	p<0.0001
Erythrocyte Sed. Rate 1hr (mm)	0-20	50.1 $\pm$ 22.9	28.1 $\pm$ 13.7	p<0.0001
Rheumatoid Factor iu	<100	117.0 $\pm$ 76.1	91.7 $\pm$ 67.4	p<0.02
C-Reactive Protein mg/L	<1.0	5.28 $\pm$ 3.62	3.73 $\pm$ 3.44	p<0.009

EXAMPLE 2

Four patients with primary Raynaud's disease were given a course of therapy according to the invention, in an open clinical trial performed at St Bartholomew's Hospital, London, under properly controlled and supervised conditions.

An investigation of an autoimmune component of the disease in these patients demonstrated high levels of antibodies specific for HSP-60 and HSP-65 in one patient. The levels of these antibodies in this patient are shown on the accompanying Figure, from which it can be seen that the levels decreased markedly following a course of therapy. The first course of treatment, indicated "1" on the Figure, consisted of 9 treatments carried out over 14 days. Furthermore, the levels of these auto-antibodies began to increase again some weeks later, and were again lowered following a second course of therapy. The second course of treatment, indicated "2" on the Figure, consisted of 5 treatments carried out over 10 days. These data suggest that therapy with blood treated according to the invention, i.e. the autovaccine described herein, may reduce an autoimmune response as evidenced by a reduction of HSP antibodies in a treated patient.

EXAMPLE 3

The helper T-lymphocyte subsets TH1 and TH2 have been measured in 13 normal control volunteers and in two patients suffering from the autoimmune disease scleroderma. The ratio of TH1:TH2 in the controls, as measured by intracellular cytokine flow cytometry, was found to be  $3.029 \pm 0.639$  (mean  $\pm$  standard deviation). The patients with scleroderma had TH1:TH2 ratios of 5.0 and 4.58 respectively, most likely, indicating an increase in the TH1 population relative to the TH2 population. In

- 21 -

inflammatory pathologies such as many autoimmune diseases there is a relative increase in the TH1 cells; therefore it was to be expected that this ratio would be higher in these patients than in the healthy control individuals.

Following a course of therapy with blood treated according to the invention (i.e. the autovaccine described herein), the TH1:TH2 ratios in these patients was 3.29 and 3.13 respectively, i.e. the ratio had approached the normal range. These data suggest that therapy with blood treated according to the present invention may reduce an autoimmune response as evidenced by a relative increase in the TH2 cells.

#### **EXAMPLE 4 - STAINING OF ACTIVATION MARKERS**

This example illustrates an experimental approach which indicates that treatment of blood with UV/ozone according to the invention has an immune-stimulatory effect on human blood, as evidenced by an increase in certain activation markers on the surface of the treated mononuclear cells.

Samples (20 ml) of peripheral blood were taken from individuals. Each sample was divided into two aliquots. The first aliquot was treated according to the inventive technique, as follows:

The 10 ml aliquot was treated in vivo for three minutes with ozone gas (variable ozone concentration of 5-50  $\mu\text{g/ml}$ ) and ultraviolet light (253.7 nm), at a temperature of 42.5°C. An apparatus similar to that disclosed in U.S. Patent No. 4,968,483 was utilized to carry out the treatment of the blood sample.

The second 10 ml aliquot from each sample served as an untreated control.

- 22 -

Each blood sample was stained for certain activation markers of T-lymphocytes and monocytes, using conventional monoclonal antibody techniques. The proportion of the total cells which stained positive for the individual markers was quantitated by microscopy. The results are as follows:

<b>Marker</b>	<b>Control</b>	<b>Ozone/UV Treated</b>
CD25 (IL-2 receptor)	1%	26%
CD2 (E-rosette receptor)	3%	33%

The above data for this example are all means of duplicates, and indicate that treatment with UV/ozone according to the invention results in the activation of T-lymphocytes and monocytes.

**I CLAIM:**

1. An autovaccine for alleviating the symptoms of an autoimmune disease in a mammalian patient suffering therefrom, comprising an aliquot of modified blood from the automminue suffering patient, the modified blood aliquot being characterized by having, in comparison with an equal volume aliquot of said patient's unmodified blood, at least one of the following distinguishing features:

- (a) increased numbers of leucocytes exhibiting increased intracellular vacuolation and abnormally smooth surface topography;
  - (b) a reduction in the number of leukocytes expressing the MHC Class II leukocyte cell surface specific protein HLA-DR;
  - (c) an upregulated expression on leukocytes of at least one cell surface marker selected from the group consisting of CD-11b;
  - (d) lymphocytes containing decreased amounts of stress protein HSP-60; and
  - (e) lymphocytes containing decreased amounts of stress protein HSP-70.
- (f) a decreased ability of the lymphocytes to proliferate in response to exogenous stimuli;
- (g) a decreased ability of neutrophils to phagocytose and undergo the oxidative burst response.

2. The autovaccine of claim 1 containing mononuclear cells of which from about 12-20% exhibit the presence therein of HSP-60.

3. The autovaccine of claim 1 containing leucocytes from which about 25-35% exhibit the presence of stress protein HSP-70.



- 24 -

4. The autovaccine of claim 1 in which the number of cells expressing HLA-DR is from about 8-12%.

5. The autovaccine of claim 1 in which the percentage of neutrophils capable of phagocytosis is up to 60% and those capable of undergoing the oxidative burst response is up to 40%.

6. The autovaccine of claim 1, having a volume from about 0.1-200 mls.

7. A process of preparing an autovaccine for administration to an autoimmune disease-suffering mammalian patient to alleviate the patient's autoimmune disease symptoms, which comprises:

extracting an aliquot of blood from the patient;  
modifying the extracted blood aliquot extracorporeally by subjecting it to an immune system-modifying amount of ozone gas and ultraviolet radiation, so as to create in the blood aliquot, in comparison with an equal volume aliquot of said patient's unmodified blood, at least one of the following distinguishing features:

- (a) increased numbers of leucocytes exhibiting increased intracellular vacuolation and abnormally smooth surface topography;
- (b) a reduction in the number of leukocytes expressing the MHC Class II leukocyte cell surface specific protein HLA-DR;
- (c) an upregulated expression on leukocytes of at least one cell surface marker selected from the group consisting of CD-11b; B-7.2; and CTLA-4;
- (d) lymphocytes containing decreased amounts of stress protein HSP-60; and

- 25 -

(e) lymphocytes containing decreased amounts of stress protein HSP-70.

(f) a decreased ability of the lymphocytes to proliferate in response to exogenous stimuli;

(g) a decreased ability of neutrophils to phagocytose and undergo the oxidative burst response.

8. The process of claim 7 wherein the aliquot size is from about 0.01-400 ml.

9. The process of claim 8 wherein the aliquot size is from about 1-50 ml.

10. The process of claim 8 wherein the ozone gas and ultraviolet radiation are applied to the blood aliquot simultaneously, at a temperature of from 37-55°C.

11. The process of claim 10 wherein the ozone is administered as a gas stream in admixture with medical grade oxygen, the ozone content therein being from 0.5-100 µg/ml, at a rate of from 0.01-2.0 litres per minute (STP), over a period of 0.5-60 minutes.

12. The process of claim 10 wherein the ultraviolet radiation is supplied from at least one ultraviolet lamp emitting in the C-band wavelength.

13. The process of claim 12 wherein the ultraviolet radiation is obtained from ultraviolet lamps emitting at least about 90% of ultraviolet radiation of a wavelength about 253.7 nm.

14. The process of claim 11 wherein the blood aliquot is treated with ozone and ultraviolet radiation at a temperature from about 37-43°C, for a period of from about

- 26 -

2-5 minutes, the ozone/oxygen mixture being supplied at a rate of from 0.1-1.0 litres per minute, with an ozone content of from about 5-50  $\mu\text{g/ml}$ .

15. The process of any of claims 7-14 wherein the patient is suffering from arthritis so that the aliquot of blood prior to modification has at least one characteristic derived from the patient's arthritic condition.

16. The process of any of claims 7-14 wherein the patient is suffering from rheumatoid arthritis so that the aliquot of blood prior to modification has at least one characteristic derived from the patient's rheumatoid arthritic condition.

17. The process of any of claims 7-14 wherein the patient is suffering from scleroderma so that the aliquot of blood prior to modification has at least one characteristic derived from the patient's scleroderma condition.

18. Use in preparation of a vaccine for administration to a patient suffering from an autoimmune disease to alleviate the symptoms thereof, of a blood aliquot obtained from the same patient and modified according to a process as claimed in any of claims 7-14.

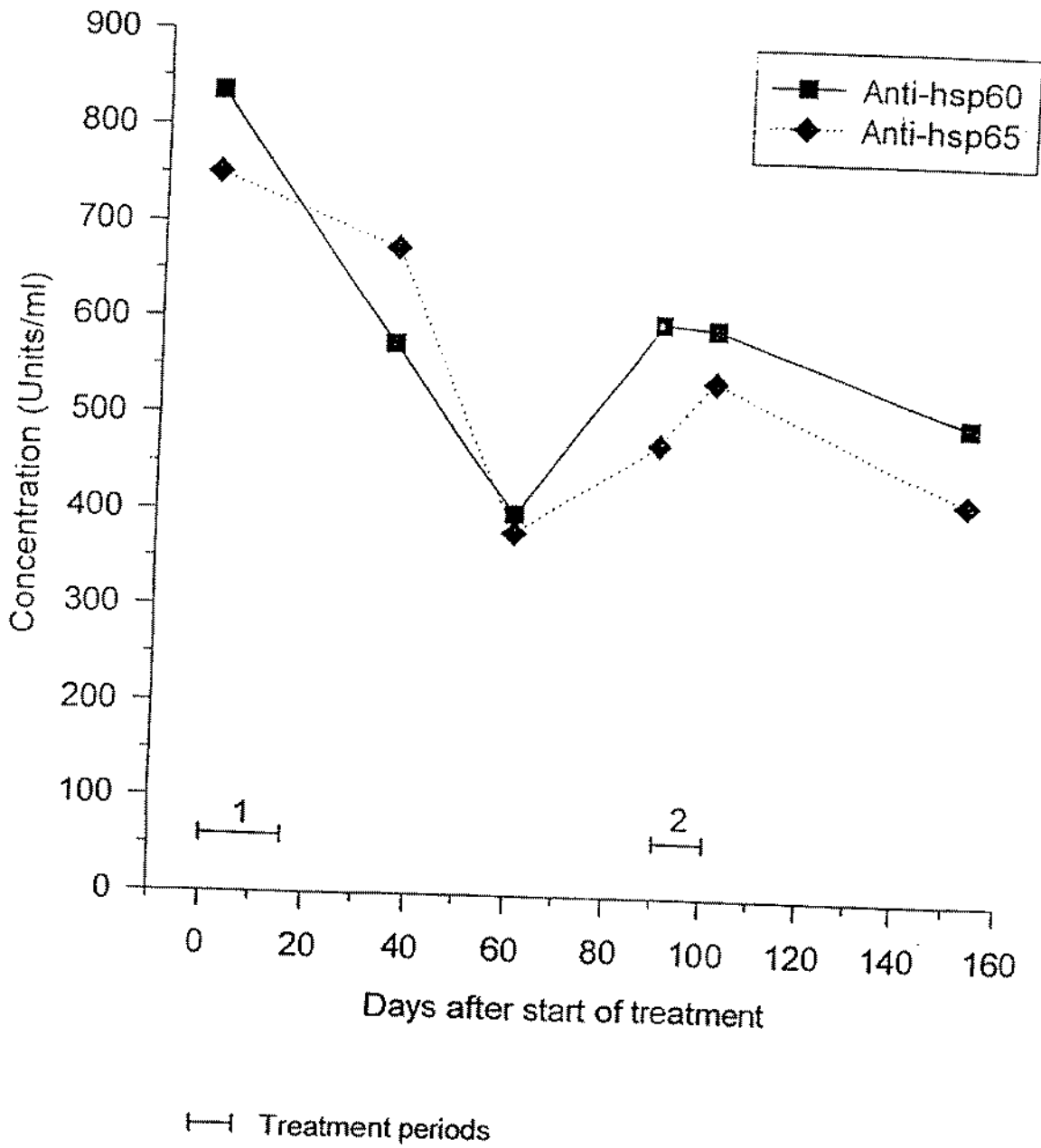
19. Use as in claim 18 wherein the patient is suffering from arthritis.

20. Use as in claim 18 wherein the patient is suffering from rheumatoid arthritis.

21. Use as in claim 18 wherein the patient is suffering from scleroderma.

FIGURE 1

Primary Raynaud's Patient 031  
Anti-hsp60 and anti-hsp65 levels after VasoCare™ Treatment



# INTERNATIONAL SEARCH REPORT

International Application No

PCT/CA 97/00564

**A. CLASSIFICATION OF SUBJECT MATTER**  
IPC 6 A61K35/14

According to International Patent Classification (IPC) or to both national classification and IPC

**B. FIELDS SEARCHED**

Minimum documentation searched (classification system followed by classification symbols)

IPC 6 A61K

Documentation searched other than minimum documentation to the extent that such documents are included in the fields searched

Electronic data base consulted during the international search (name of data base and, where practical, search terms used)

**C. DOCUMENTS CONSIDERED TO BE RELEVANT**

Category *	Citation of document, with indication, where appropriate, of the relevant passages	Relevant to claim No.
A	EOELSON R L: "PHOTOPHERESIS: A CLINICALLY RELEVANT IMMUNOBIOLOGIC RESPONSE MODIFIER" ANNALS OF THE NEW YORK ACADEMY OF SCIENCES, vol. 636, 1 January 1991, pages 154-164, XP000571689 see page 162-163, 'Summary'	1-21
A	EP 0 111 418 A (KENYON & KENYON) 20 June 1984 see page 6, line 33 - page 8, line 29	1-21
A	EP 0 284 409 A (THERAKOS INC) 28 September 1988 see page 3, line 39 - line 64 see page 5, line 23 - page 6, line 3	1-21
	-/--	

Further documents are listed in the continuation of box C.

Patent family members are listed in annex.

\* Special categories of cited documents:

- "A" document defining the general state of the art which is not considered to be of particular relevance
- "E" earlier document but published on or after the international filing date
- "L" document which may throw doubts on priority claim(s) or which is cited to establish the publication date of another citation or other special reason (as specified)
- "O" document referring to an oral disclosure, use, exhibition or other means
- "P" document published prior to the international filing date but later than the priority date claimed

- "T" later document published after the international filing date or priority date and not in conflict with the application but cited to understand the principle or theory underlying the invention
- "X" document of particular relevance; the claimed invention cannot be considered novel or cannot be considered to involve an inventive step when the document is taken alone
- "Y" document of particular relevance; the claimed invention cannot be considered to involve an inventive step when the document is combined with one or more other such documents, such combination being obvious to a person skilled in the art.
- "&" document member of the same patent family

Date of the actual completion of the international search

17 November 1997

Date of mailing of the international search report

01/12/1997

Name and mailing address of the ISA  
European Patent Office, P.B. 5818 Patentlaan 2  
NL - 2280 HV Rijswijk  
Tel. (+31-70) 340-2040, Tx. 31 651 epo.nl  
Fax: (+31-70) 340-3016

Authorized officer

Sitch, W

## INTERNATIONAL SEARCH REPORT

International Application No

PCT/CA 97/00564

C.(Continuation) DOCUMENTS CONSIDERED TO BE RELEVANT		
Category	Citation of document, with indication, where appropriate, of the relevant passages	Relevant to claim No.
A	WO 92 1019B A (JOHNSON & JOHNSON RESEARCH PTY) 25 June 1992 see page 4, line 3B - page 7, line 28 ---	1-21
A	DATABASE MEOLINE FILE SERVER STN KARLSRUHE ABSTRACT 93217005, KNOBLER ET AL: "PARENTERAL ADMINISTRATION OF 8-METHOXYPORALEN IN PHOTOPHERESIS" XP002047225 see abstract & JOURNAL OF THE AMERICAN ACADEMY OF DERMATOLOGY, vol. 2B, no. 4, April 1993, pages 580-584, ---	1-21
A	DATABASE MEOLINE FILE SERVER STN KARLSRUHE ABSTRACT 90183596, ROOK ET AL: "EXTRACORPOREAL PHOTOCHEMOTHERAPY IN THE TREATMENT OF CUTANEOUS T CELL LYMPHOMA AND AUTOIMMUNE DISORDERS AFFECTING THE SKIN" XP002047226 see abstract & CIBA FOUNDATION SYMPOSIUM, vol. 146, 1989, pages 171-177, -----	1-21

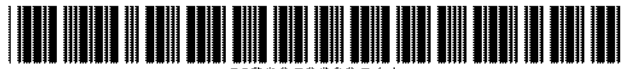
# INTERNATIONAL SEARCH REPORT

Information on patent family members

Intern. Application No

PCT/CA 97/00564

Patent document cited in search report	Publication date	Patent family member(s)	Publication date
EP 0111418 A	20-06-84	US 4612007 A	16-09-86
		US 4613322 A	23-09-86
		CA 1235191 A	12-04-88
		OE 3375712 A	31-03-88
		JP 1956970 C	10-08-95
		JP 6071482 8	14-09-94
		JP 59155257 A	04-09-84
		US 4684521 A	04-08-87
		US 4683889 A	04-08-87
		EP 0284409 A	28-09-88
AU 606666 8	14-02-91		
AU 1358488 A	29-09-88		
CA 1306678 A	25-08-92		
OK 166688 A	28-09-88		
GR 1000039 B	12-03-90		
JP 63275525 A	14-11-88		
PH 25590 A	08-08-91		
WO 9210198 A	25-06-92	NONE	



US005980954A

**United States Patent** [19]  
**Bolton**

[11] **Patent Number:** **5,980,954**  
[45] **Date of Patent:** **Nov. 9, 1999**

[54] **TREATMENT OF AUTOIMMUNE DISEASES**

[75] Inventor: **Anthony E. Bolton**, Toronto, Canada

[73] Assignee: **Vasogen Ireland Limited**, Ireland

[21] Appl. No.: **08/754,348**

[22] Filed: **Nov. 22, 1996**

4,632,980	12/1986	Zee et al. ....	530/380
4,831,268	5/1989	Fisch et al. ....	250/432
4,968,483	11/1990	Mueller et al. ....	422/520
5,052,382	10/1991	Wainwright .....	128/202.25

**Related U.S. Application Data**

[63] Continuation-in-part of application No. 08/352,802, Dec. 1, 1994, Pat. No. 5,591,457, which is a continuation-in-part of application No. 07/941,327, Sep. 4, 1992, abandoned, which is a continuation-in-part of application No. 07/832,798, Feb. 7, 1992, abandoned.

[30] **Foreign Application Priority Data**

Aug. 22, 1996 [GB] United Kingdom ..... 96176110

[51] **Int. Cl.<sup>6</sup>** ..... **A01N 39/00**

[52] **U.S. Cl.** ..... **424/613; 424/810; 422/24; 422/44; 422/45; 422/46; 604/4**

[58] **Field of Search** ..... 424/93.21, 278.1, 424/829, 613, 810; 435/372, 375, 377; 604/4, 422/24, 44, 45, 46

[56] **References Cited**

**U.S. PATENT DOCUMENTS**

3,715,430 2/1973 Ryan ..... 424/127

**OTHER PUBLICATIONS**

D. Baran et al. (associates) "Technical Report and Clinical Update" Mueller Medical International Inc., Oakville, Ontario, Canada, Sep. 1990.

*Primary Examiner*—Christina Y. Chan

*Assistant Examiner*—Patrick Nolan

*Attorney, Agent, or Firm*—Ridout & Maybee; Robert G. Hirons

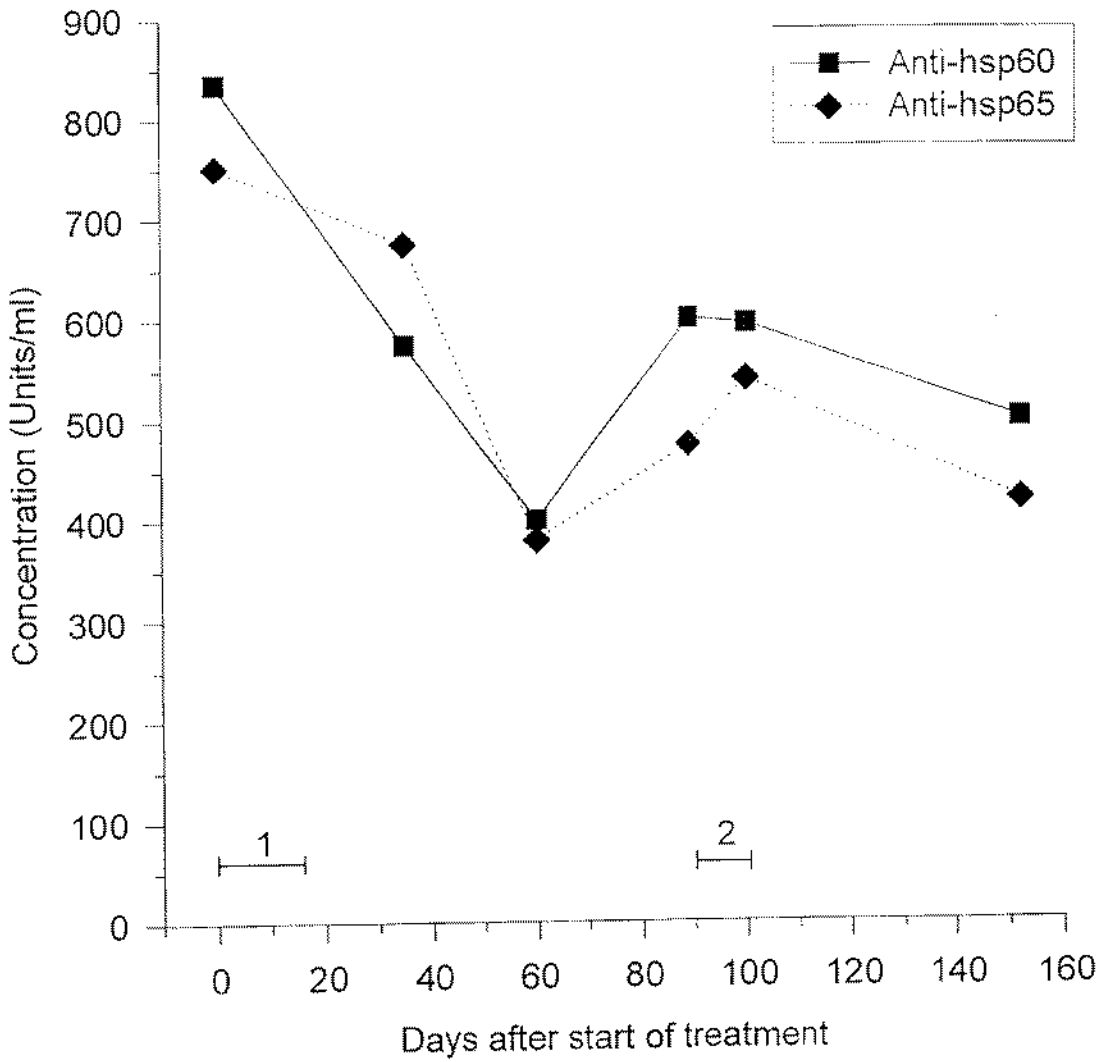
[57] **ABSTRACT**

An autoimmune vaccine is provided for administration to human patients to alleviate the symptoms of autoimmune diseases such as rheumatoid arthritis. The vaccine comprises an aliquot of the patient's blood, containing, inter alia, leukocytes having upregulated expression of various cell surface markers and lymphocytes containing decreased amounts of certain stress proteins. It is produced by subjecting the blood aliquot extracorporeally to certain stressors, namely oxidizing agents, UV radiation and elevated temperature.

**12 Claims, 1 Drawing Sheet**



Primary Raynaud's Patient 031  
Anti-hsp60 and anti-hsp65 levels after VasoCare™ Treatment



— Treatment periods

## TREATMENT OF AUTOIMMUNE DISEASES

This application is a continuation-in-part of U.S. patent application Ser. No. 08/352,802 filed Dec. 1, 1994 and now U.S. Pat. No. 5,591,457, which is in turn a continuation-in-part of U.S. patent application Ser. No. 07/941,327 filed Sep. 4, 1992 and now abandoned, which was in a turn a continuation-in-part of U.S. patent application Ser. No. 07/832,798 (now abandoned) filed Feb. 7, 1992.

### FIELD OF THE INVENTION

This invention relates to vaccines, their preparation and use in medical treatments. More particularly, it relates to treatments for alleviating autoimmune diseases and their symptoms, to a vaccine useful therein, and to processes for preparing and using such a vaccine.

### BACKGROUND OF THE INVENTION

Autoimmune diseases include rheumatoid arthritis, graft versus host disease, systemic lupus erythematosus (SLE), scleroderma, multiple sclerosis, diabetes, organ rejection, inflammatory bowel disease, psoriasis, and other afflictions. It is becoming increasingly apparent that many vascular disorders, including atherosclerotic forms of such disorders, have an autoimmune component, and a number of patients with vascular disease have circulating auto antibodies. Autoimmune diseases may be divided into two general types, namely systemic autoimmune diseases (exemplified by arthritis, lupus and scleroderma), and organ specific (exemplified by multiple sclerosis, diabetes and atherosclerosis, in which latter case the vasculature is regarded as a specific organ).

In general terms, a normally functioning immune system distinguishes between the antigens of foreign invading organisms (non-self) and tissues native to its own body (self), so as to provide a defence against foreign organisms. Central to the proper functioning of the immune system, therefore, is the ability of the system to discriminate between self and non-self. When a patient's immune system fails to discriminate between self and non-self and starts to react against self antigens, then an autoimmune disorder may arise.

The causes responsible for the reaction of an affected person's immune system against self are not fully understood, and several different theories have been put forward. The immune response to an antigen is triggered by the interaction of the antigen with receptors of predetermined specificity on certain lymphocytes. It is believed that, at an early stage in development of the immune system, those lymphocytes with receptors recognizing self antigens are recognized and eliminated from the body's system by a process of deletion. Alternatively, or in addition, such self-reactive lymphocytes may be controlled by the suppression of their activities. Both mechanisms probably occur.

The immune system of normal healthy individuals is able to identify and to react against a family of proteins which are highly conserved in nature (i.e. they have a similar structure throughout all living organisms). This family of proteins is called the stress or heat-shock proteins (HSP), and they are grouped according to their approximate molecular weights. Members of the HSP family include the HSP60 group, including, among others, proteins in the molecular weight range 50 to 100 kilodaltons. Increased production of HSP's was first identified as a response to heat stress, but this now appears to be part of a general response to a variety of cell stresses. HSPs are normally located within cells, and their

function appears to be the stabilization of the structure of various proteins in stressed cells, so as to protect the cell from the protein denaturing effects of various stressors. However, it is likely that HSPs have a number of other functions which are, as yet, not fully understood. Heat shock proteins, HSP's, are discussed in some detail by William J. Welch, in an article in "Scientific American", May, 1993, page 56.

One group of the family of HSP's, the HSP 60 group, contains proteins which show about 50% identity between bacterial cells and human cells. Infection with bacteria containing HSP 65 results in an immune response in healthy humans against the bacterial HSP65, evidenced by the production of anti-HSP65 antibodies. Thus, a healthy immune system appears to be able to identify and react against self-like antigens.

In certain pathologies, for example many autoimmune diseases such as rheumatoid arthritis and scleroderma, patients also show the presence of antibodies to HSP 65. In the past, this has led to conclusions that autoimmune diseases result from bacterial infection. Now it seems likely that autoimmune diseases are associated with an inappropriate control of the autoimmune response. In other words, it is possible that the antibodies to HSP 65 result from an autoimmune reaction initiated by HSPs from the body itself, but one which has been improperly controlled. In such cases, therefore, it should be possible to control an inappropriate autoimmune response, by stimulating the body's natural immune control mechanisms, using a particular and specific method of vaccination.

To stimulate the body's immune response, a vaccine is required which will, upon injection into the host body, enable the host immune system to present the antigens contained in the vaccine to cells of the host immune system. Antigen presentation is performed by antigen presenting cells.

A vaccine to treat autoimmune diseases should contain antigens or fragments thereof (peptides) that will activate the body's immune control mechanisms present. In addition, the antigens (peptides) should be present in a form which can be recognized by the host immune system when the vaccine is introduced into the host. Certain of the antigens may be present on intact cells. The objective of such a vaccination is to activate regulatory immune pathways, particularly those controlling autoimmune responses, thereby downregulating the autoimmune response.

The particular antigens which will activate the control mechanisms of a mammalian autoimmune system are not fully understood. It is however recognized that they may include antigens derived from lymphocyte receptors, which may function to stimulate control mechanisms, to inhibit those lymphocytes which cause pathological autoimmune responses in the patient. They may also include HSPs, such as the HSP 60 group of proteins, and leucocyte surface molecules such as those of the Major Histocompatibility Complex (MHC) including MHC Class II molecules. MHC Class II molecules function physiologically to present peptides to CD4<sup>+</sup> T-cells as part of the immune response.

It is important that the lymphocyte receptors and other cell-derived molecules for vaccination of an auto-immune suffering patient be derived from cells obtained from the same patient, since this system will contain the autoimmune specificity. Receptors on other leucocytes in the blood may alternatively or additionally be important in a proposed vaccination process. The use of such a system as the basis of a vaccine may be considered analogous to the use of a

particular viral antigen as a vaccine to treat and prevent disease caused by that virus. A vaccine for treating an autoimmune disease should, therefore, be prepared from a sample of the patient's own blood. Such a vaccine may be described as an autovaccine.

For antigens to be effective in stimulating (or inhibiting) the immune system, the antigens should be presented to immune cells of the host system by antigen-presenting cells, which are naturally present in the body. Many of the antigen-presenting cells are phagocytes, which attach to the antigens, engulf them by phagocytosis, and break them down or process them. The preparation of such an autovaccine should include a process whereby the lymphocytes and other leucocytes in the vaccine, which may be a source of antigens, are modified into a form whereby they are likely to be phagocytosed by phagocytic antigen-presenting cells upon re-injection into the patient, so that the antigens or effective residues thereof are presented on the surface of an antigen-presenting cell. Then they can effect a controlling mechanism on the immune system, either inhibitory or stimulatory.

During the normal growth period of a mammalian body, tissues become reshaped with areas of cells being removed. This is accomplished by the cells' undergoing a process called programmed cell death or apoptosis, the apoptotic cells disintegrating and being phagocytosed while not becoming disrupted.

#### BRIEF REFERENCE TO THE PRIOR ART

U.S. Pat. No. 3,715,430 Ryan relates to a method and apparatus for producing substantially pure oxygen having a controlled content of ozone and higher oxygen polymers. The purified oxygen gas is exposed to ultraviolet light in a wavelength of 2485 to 2537 angstrom units in order to produce 5 to 500 parts per million of ozone and higher oxygen polymers in the gas mixture. Ryan indicates that the gas produced in this manner is non-irritating to the human body and may be intravenously injected into the blood stream for therapeutic use.

U.S. Pat. No. 4,632,980 Zee et al. discloses a method of freeing blood and blood components of enveloped viruses by contacting the blood or blood product in an aqueous medium with an enveloped virus inactivating amount of ozone. The treatment is carried out at a temperature of 4° to 37° C., and an ozone concentration of 1-100 ppm.

U.S. Pat. No. 4,831,268 Fisch et al. provides a method for the radiation of blood to prevent arteriosclerosis related heart and vascular diseases caused by disturbances in the fat exchange. The disclosed process involves irradiating the blood in a blood conducting tube with radiation having an intensity of from about 1 mWcm<sup>-2</sup> to 10 mWcm<sup>-2</sup> in a wavelength range of from about 300 to 600 nm.

U.S. Pat. No. 4,968,483 Mueller et al. describes an apparatus for oxygenating blood, by treating an aliquot of a patient's blood, extracorporeally, with an oxygen/ozone mixture and ultraviolet light, at a controlled temperature. The apparatus is proposed for use in haematological oxidation therapy.

U.S. Pat. No. 5,052,382 Wainwright discloses an apparatus for the controlled generation and administration of ozone. The apparatus includes a generator for generating ozone, a monitor for monitoring the ozone production, a dosage device for providing a predetermined amount of ozone administration, and a computer control device for controlling the operation of the apparatus. The patent further discloses that administration of ozone to patients is known

for the treatment of viral and bacterial infections, as well as for the treatment of external sores and wounds.

#### SUMMARY OF THE INVENTION

It is an object of the present invention to provide a novel autovaccine useful in the alleviation of symptoms of at least one autoimmune disease.

It is a further object of the present invention to provide a novel process for the preparation of such an autovaccine.

It is a further and more specific object of the present invention to provide a novel treatment for the alleviation of the symptoms of at least one autoimmune disease in a human patient suffering therefrom.

Accordingly, the present invention provides, from a first aspect, an autovaccine for treatment of an autoimmune disease in a mammalian patient, and derived from an aliquot of the autoimmune patient's own blood. The autovaccine is characterized by the presence therein, in comparison with the normal blood of the autoimmune patient, of at least one of the following characterizing features:

increased numbers of lymphocytes and other leucocytes, exhibiting a condensed apoptotic-like morphology;

a release of specific proteins from the cell surface of the blood leucocytes, including the MHC Class II molecule HLA-DR, resulting in a reduction in the number of cells expressing such surface proteins;

an upregulation in the expression of certain cell surface markers for example CD-11b, a component of the ligand for the cell adhesion molecule ICAM-1; and certain T-cell regulatory molecules;

an increase in the amount of heat shock protein HSP-60 in the plasma;

a decrease in HSP-72 within the lymphocytes.

By inducing an apoptotic-like state in the lymphocytes and other leucocytes in the blood comprising the autovaccine, as evidenced by the increased numbers of lymphocytes and other leucocytes exhibiting a condensed apoptotic-like morphology therein, these cells may become more readily phagocytosed upon re-injection into the host body.

There are a number of different phagocytic cell types present in the mammalian body, including various antigen presenting cells and neutrophils. In order to facilitate phagocytosis by antigen presenting cells rather than by other phagocytes, the lymphocytes and other leucocytes present in the autovaccine of the invention are treated so that they may interact preferentially with antigen presenting phagocytic cells. Cells adhere to each other by a number of mechanisms including the expression of cell adhesion molecules. Cell adhesion molecules present on one cell type interact with specific ligands for particular adhesion molecules present on the adhering cell type. The present invention may result in a preferential interaction of cells in the autovaccine to antigen presenting cells in the host body, by upregulation, on the surface of the cells in the autovaccine, of the expression of the ligand for adhesion molecules found on antigen-presenting cells in the host body. Antigen presenting cells express a number of cell adhesion molecules, including ICAM-1, a component of the ligand of which is CD-11b. One way by which the process of the invention may change the preferential phagocytosis of apoptosing cells is by upregulation of CD-11b.

The preparation of the autovaccine according to the present invention comprises extracting from the patient suffering from an autoimmune disease an aliquot of blood of

volume about 0.01 ml to about 400 ml, and contacting the aliquot of blood, extracorporeally, with an immune system-stimulating effective amount of ozone gas and ultraviolet radiation.

The treatment for the alleviation of the symptoms of at least one autoimmune disease in a human patient suffering therefrom, in accordance with the present invention, comprises extracting from the patient an aliquot of blood of volume about 0.001 ml to about 400 ml, contacting the aliquot of blood, extracorporeally, with an immune system-stimulating amount of ozone gas and ultraviolet radiation, followed by administering the treated blood aliquot to the human patient.

#### BRIEF REFERENCE TO THE DRAWINGS

The accompanying drawing FIGURE is a graphical presentation of the results of Example 2 below.

#### DESCRIPTION OF THE PREFERRED EMBODIMENTS

When the autovaccine according to the present invention is injected into the autoimmune patient, significant alleviation of the patient's autoimmune condition is experienced, as set out in the specific embodiments of the invention described below. Exactly how the vaccine operates following this re-injection is not currently fully understood. The following tentative explanations are offered for a better and more complete description of the invention, but are not to be considered as binding or limiting.

T-cells, which are one kind of lymphocyte and which play a significant role in the control of the immune system, include CD-8 cells, and CD-4 cells otherwise known as T-helper cells, further subdividable into TH1 and TH2 cells. The TH1 cells secrete pro-inflammatory cytokines such as interferon gamma. The TH2 cells are considered to be regulatory cells and secrete regulatory cytokines, such as interleukin-4. In a normal, healthy individual, the ratio of TH1 cells to TH2 cells is around 3:1. In autoimmune conditions, there is usually an imbalance in the TH cell types, often with an increase in the TH1 cells compared to the TH2 cells, i.e. there is a change in the ratio between them, with a consequent development of an inflammatory condition often noted in autoimmune disease. A number of components of the autovaccine of the present invention, including HLA-DR and/or other MHC antigens released from the leucocyte cell surfaces, upregulate the TH2 cells in the patient's blood, thereby increasing the secretion of regulatory cytokines, and/or upregulating the suppressor cells to stimulate an inhibitory pathway for the autoimmune disease and alleviate or even switch off the autoimmune response pathway.

It is also commonly accepted that autoimmune disease sufferers may have significant populations of abnormal autoreactive T-cells, which are partly responsible for the autoimmune disease. The autoimmune disease suffering patient's ability to suppress these autoreactive T-cells is compromised. The autovaccine of the invention restores the system towards a normal immune state.

The autovaccine is prepared by exposing the blood aliquot to at least one stressor, in controlled amounts, the stressor being selected from among oxidizing agents such as ozone, ultraviolet radiation and elevated temperature, and combinations of two or more of such stressors. The resulting blood aliquot, after such treatment, serves as an autovaccine, and can be re-injected into the autoimmune patient. Following a course of such treatments, a patient's signs and symptoms of

autoimmune disease such as those of rheumatoid arthritis, scleroderma and the like are markedly reduced. The subjective reports of alleviation of symptoms of rheumatoid arthritis are consistent with objective measurements of relative erythrocyte sedimentation rates, an objective test accepted as meaningful in measuring the progression of an autoimmune disease such as rheumatoid arthritis, by the American College of Rheumatology.

In preparing the autovaccine according to the invention, by modification of a blood aliquot extracted from the patient, the blood cells are stressed. This affects the heat shock proteins, HSP, contained in the cell. HSP-60 levels in the mononuclear cells are reduced, and are increased in the plasma. Further, the level of HSP-72 present in the mononuclear cells is reduced. Also as a result of the process of the invention, certain surface (membrane) proteins on the lymphocytes, for example HLA-DR, are reduced whereas others, such as CD-3, do not change and yet others such as CD-11b in neutrophils are upregulated. Accordingly it is apparently not a non-specific membrane change which is occurring, nor is it cell destruction. It is a complex active process.

On microscopic visualization of the autovaccine according to the present invention, mononuclear cells with a condensed apoptotic-like morphology can be observed, suggesting the presence in the autovaccine of increased numbers of apoptosing cells capable of preferential phagocytosis upon reinjection, for appropriate presentation of the antigens of the auto-immune disease.

In the preferred autovaccine in accordance with the present invention, the number of mononuclear cells or leucocytes exhibiting the presence of HSP-60 therein is decreased, as does the amount of HSP-60 in each cell, as compared with the normal, untreated peripheral blood of the source patient. Whereas the patient normally has, typically, about 30% of mononuclear cells exhibiting the presence of HSP-60 therein (as measured by whole blood intracellular flow cytometry), the autovaccine has only 12-20%. In clinical studies, it has been found that the figure reduces from 29.3% to 15.5%, mean of six tests. Preferably also, the number of leucocytes exhibiting the presence of HSP-72, which is about 50% in the untreated blood of the source patient, is reduced to 25-35% in the autovaccine of the present invention. In clinical studies, this figure for HSP-72 reduced from 49.4% in untreated blood to 30.2% in the autovaccine, mean of six tests, similarly measured.

The number of cells which express the cell surface specific protein HLA-DR, in the preferred autovaccine of the present invention, is reduced as compared with the patient's untreated blood, possibly as a result of its release from the cell surface. Typically, the number of cells expressing HLA-DR reduces from about 23% to about 8-12%, as measured by whole blood flow cytometry. In clinical studies, this figure reduced from 23.3% to 10.3%, mean of five experiments.

The upregulation of the surface marker CD-11b in the preferred autovaccine of the present invention can be expressed as an increase in the percentage of neutrophils in the autovaccine which test positive for CD-11b, compared with the patient's source blood. Typically, the increase is from about 10% up to the approximate range 70-95%. In clinical studies, an increase from 10.3% to 84% was obtained, mean of six tests.

A significant feature of the present invention is that the source of the blood from which the autovaccine is prepared for a specific patient suffering from an autoimmune disease

is the patient himself or herself. The antigens forming the basis of the autovaccine find their origin in the patient's own blood. No extraneous antigens are added; the effective antigens are present in the patient's blood, and/or are released or modified by the process of preparing the auto-vaccine using the patient's own blood as the source material. Moreover, in many cases, the precise autoimmune disease from which the patient suffers appears to be immaterial. The antigens for the autovaccine for the disease are present in, or are developed by treatment of, the patient's own blood.

Preferably, the stressors to which the leucocytes in the extracted blood aliquot are subjected are a temperature stress (blood temperature above body temperature), an oxidative environment, such as a mixture of ozone and oxygen bubbled through the blood aliquot, and ultraviolet radiation, simultaneously or successively, but preferably simultaneously.

The present invention provides a method of alleviating the symptoms of an autoimmune disease in a human, which comprises:

(a) contacting of about 0.01 ml to about 400 ml of blood with an immune system modifying effective amount of ozone gas and ultraviolet radiation; and

(b) administering the blood treated in step (a) to a human.

In general, from about 0.01 ml to about 400 ml of blood may be treated according to the invention. Preferred amounts are in the range of about 0.1 ml to 200 ml. More suitably, the aliquot for treatment has a volume of from about 0.1–100 mls, preferably 1–50 ml and most preferably 5–15 mls. The method most preferably involves treating an aliquot of about 10 mls of blood with ozone gas and ultraviolet radiation, then re-administering the treated blood to the patient by intramuscular injection.

As noted, it is preferred, according to the invention, to apply all three of the aforementioned stressors simultaneously to the aliquot under treatment. Care must be taken not to utilize an excessive level of the stressors, to the extent that the cell membranes of the white cells are caused to be disrupted.

The temperature stressor must keep the aliquot in the liquid phase, i.e. from about 0° C. to about 56° C. and should not heat it above about 55° C. Any suitable source of heat known in the art may be employed to heat the blood, preferably one or more infrared lamps. Preferably the temperature stressor warms the aliquot being treated, to a temperature above normal body temperature, i.e. to about 37–55° C., and most preferably from about 37–43° C., e.g. about 42.5° C. Preferably the temperature of the blood aliquot is maintained at this elevated temperature during the treatment with UV/ozone.

Alternatively, the blood sample is heated while being subjected to UV radiation, until the blood reaches a predetermined temperature (preferably about 42.5° C.), at which point bubbling of ozone gas through the blood is commenced. The concurrent UV/ozone treatment is then maintained for a predetermined period of time, preferably about 3 minutes.

Another alternative method involves subjecting the blood to UV/ozone while heating to a predetermined temperature (preferably about 42.5° C.), then either ending the treatment once the predetermined temperature is reached, or continuing UV/ozone treatment for a further period of time, most preferably about 3 minutes.

The application of the oxidative stressor preferably involves exposing the aliquot to a mixture of medical grade oxygen and ozone gas, most preferably by bubbling through the aliquot, at the aforementioned temperature range, a

stream of medical grade oxygen gas having ozone as a minor component therein. The ozone gas may be provided by any conventional source known in the art. Suitably the gas stream has an ozone content of from about 1.0–100 µg/ml, preferably 3–70 µg/ml, and most preferably from about 5–50 µg/ml. The gas stream is supplied to the aliquot at a rate of from about 0.01–2.0 liters per minute, preferably 0.1–1.0 liters per minute and most preferably at about 0.12 liters per minute (STP).

The ultraviolet radiation stressor is suitably applied by irradiating the aliquot under treatment from an appropriate source of UV radiation, while the aliquot is maintained at the aforementioned temperature and while the oxygen/ozone gaseous mixture is being bubbled through the aliquot. The ultraviolet radiation may be provided by any conventional source known in the art, for example by a plurality of low-pressure ultraviolet lamps. The method of the invention preferably utilizes a standard UV-C source of ultraviolet radiation, namely UV lamps emitting in the C-band wavelengths, i.e. at wavelengths shorter than about 280 nm. Ultraviolet radiation corresponding to standard UV-A and UV-B sources can also be used. Preferably employed are low-pressure ultraviolet lamps that generate a line spectrum wherein at least 90% of the radiation has a wavelength of about 253.7 nm. An appropriate dosage of such UV radiation, applied simultaneously with the aforementioned temperature and oxidative environment stressors, is obtained from lamps with a power output of from about 15 to about 25 watts, at the chosen UV wavelength, arranged to surround the sample container holding the aliquot, each lamp providing an intensity, at a distance of 1 meter, of from about 45–65 mW/sq.cm. Several such lamps surrounding the sample bottle, with a combined output at 253.7 nm of 15–25 watts, operated at maximum intensity, may advantageously be used. At the incident surface of the blood, the UV energy supplied is 0.2–0.25 Joules per cm<sup>2</sup>. Such a treatment provides a blood aliquot which is appropriately modified according to the invention to create the auto-vaccine outlined above ready for re-injection into the patient.

The time for which the aliquot is subjected to the stressors can be from a few seconds to about 60 minutes. It is normally within the time range of from about 0.5–60 minutes. This depends to some extent upon the chosen intensity of the UV irradiation, the temperature and the concentration of and rate at which the oxidizing agent is supplied to the aliquot. The more severe the stressors applied to the aliquot, generally the shorter time for which they need to be applied. Some experimentation to establish optimum times may be necessary on the part of the operator, once the other stressor levels have been set. Under most stressor conditions, preferred times will be in the approximate range of about 0.5–10 minutes, most preferably 2–5 minutes, and normally around 3 minutes. The starting blood temperature, and the rate at which it can be warmed or cooled to a predetermined temperature, tends to vary from patient to patient.

In the practice of the preferred process of the present invention, the blood aliquot (or the separated cellular fractions of the blood, or mixtures of the separated cells, including platelets, these various leucocyte-containing combinations, along with whole blood, being referred to collectively throughout as the "aliquot") may be treated with the stressors using an apparatus of the type described in U.S. Pat. No. 4,968,483 Mueller. The aliquot is placed in a suitable, sterile, UV-radiation-transmissive container, which is then fitted into the machine. The temperature of the aliquot is adjusted to the predetermined value, e.g. 42.5° C., by the use of a suitable heat source such as an IR lamp, and the UV

lamps are switched on for a fixed period before the gas flow is applied to the aliquot providing the oxidative stress, to allow the output of the UV lamps to stabilize. Then the oxygen/ozone gas mixture, of known composition and controlled flow rate, is applied to the aliquot, for the predetermined duration of 0.5–60 minutes, preferably 2–5 minutes and most preferably about 3 minutes as discussed above, so that the aliquot experiences all three stressors simultaneously. In this way, the blood aliquot is appropriately modified to produce an auto-vaccine according to the present invention sufficient to achieve the desired effects.

Example 4 below supports the finding that the method of treating blood according to the invention has an immune modifying effect. In particular, treatment of blood with UV/ozone has been found to increase the expression of activation markers on the surface of the lymphocytes (see Example 5).

Thus, the invention also provides a method of stimulating or activating the immune system in a human by contacting about 0.01 ml to about 400 ml of blood from a human with an immune system-stimulating effect amount of ozone gas and ultraviolet radiation, followed by administering the treated blood to a human. Similarly, the invention contemplates a method of treating an immune system disorder in a human, by contacting about 0.01 ml to about 400 ml of blood from a human with an immune system-stimulating effective amount of ozone gas and ultraviolet radiation, followed by administering the treated blood to a human.

The immune system disorders which may be treated by this method include allergic conditions, autoimmune conditions, and an inflammatory conditions. Specific immune system disorders which may be treated according to the invention include rheumatoid arthritis, scleroderma, diabetes mellitus, organ rejection, miscarriage, multiple sclerosis, inflammatory bowel disease, psoriasis, and other inflammatory disorders. The discoveries of the present invention may also be applied to treat autoimmune diseases which manifest as infertility, including endometriosis. It is also effective in treatment of atherosclerosis, which can be regarded as an autoimmune disease of the vasculature.

The invention is further described for illustrative purposes with reference to specific examples of clinical use of it and objective and subjective results from such clinical uses.

#### SPECIFIC DESCRIPTION OF THE MOST PREFERRED EMBODIMENTS

##### EXAMPLE 1

Thirty patients with active rheumatoid arthritis, 21 females and 9 males, were treated by the preferred process according to the present invention. The age range of the patients was 26–72 years, with the mean age 52.2 years, at the start of the study. Each patient received between 30 and 60 individual treatments (mean 48.3 treatments) over a time span of 62 weeks (mean 20.6 weeks). Each individual treatment consisted of the removal of a 10 mL aliquot of blood, the treatment of the blood aliquot simultaneously with gaseous oxygen/ozone mixture and ultraviolet light at elevated temperature using an apparatus as generally described in the aforementioned U.S. Pat. No. 4,968,483 Mueller et al.

The constitution of the gas mixture was 14–15 mcg/mL ozone/medical grade oxygen. The gas mixture was fed through the aliquot at a rate of about 200 mLs/minute, for a period of 3 minutes. The temperature of the aliquot was held steady at 42.5° C. The UV radiation had a wavelength of 253.7 nm.

Post treatment measurements were conducted 1 day to nine months after the final treatment of each patient (mean 12.4 weeks). Blood samples were taken and analyzed for leucocytes, erythrocyte sedimentation rate, rheumatoid factor and C-reactive protein, using standard test procedures. The erythrocyte sedimentation rate and C-reactive protein are elevated in most inflammatory conditions including rheumatoid arthritis, and Rheumatoid Factor is elevated in most cases of rheumatoid arthritis as well as in some cases of certain other auto-immune diseases. White blood cell count, erythrocyte sedimentation rate, rheumatoid factor and C-reactive protein all showed significant reduction after the course of treatment. Particularly noteworthy is the significant reduction in erythrocyte sedimentation rate, an indicator of rheumatoid arthritis improvement, accepted by the American College of Rheumatology.

In addition, patients were rated by medical personnel subjectively, for the apparent severity of their rheumatoid arthritis symptoms, before and after the courses of treatment, on a scale of 5 (very bad) to 1 (excellent). Again, a marked improvement in each case was reported.

The mean results are given in the following Table.

TABLE

Clinical Measurements	Normal Ranges	(Pre-Treatment Mean $\pm$ SD)	Post-Treatment (Mean $\pm$ SD)	Paired T-test
Symptom Rating		3.9 $\pm$ 0.9	2.6 $\pm$ 0.6	p < 0.0001
Leucocytes 10 <sup>9</sup> /L	4.0–10.0	11.68 $\pm$ 2.84	8.70 $\pm$ 1.02	p < 0.0001
Erythrocyte Sed. Rate 1 hr (mm)	0–20	50.1 $\pm$ 22.9	28.1 $\pm$ 13.7	p < 0.0001
Rheumatoid Factor in C-Reactive Protein mg/L	<100	117.0 $\pm$ 76.1	91.7 $\pm$ 67.4	p < 0.02
	<1.0	5.28 $\pm$ 3.62	3.73 $\pm$ 3.44	p < 0.009

##### EXAMPLE 2

Four patients with primary Raynaud's disease were given a course of therapy according to the invention, in an open clinical trial performed at St Bartholomew's Hospital, London, under properly controlled and supervised conditions. All four patients showed alleviation of their symptoms following treatment.

An investigation of an autoimmune component of the disease in these patients demonstrated high levels of auto-antibodies specific for HSP-60 and HSP-65 in one patient. The levels of these auto-antibodies in this patient are shown on the accompanying FIGURE, from which it can be seen that the levels decreased markedly following a course of therapy. The first course of treatment, indicated "1" on the FIGURE, consisted of 9 treatments carried out over 14 days. Furthermore, the levels of these auto-antibodies began to increase again some weeks later, and were again lowered following a second course of therapy. The second course of treatment, indicated "2" on the FIGURE, consisted of 5 treatments carried out over 10 days. These data suggest that therapy with blood treated according to the invention, i.e. the autovaccine described herein, may reduce an autoimmune response as evidenced by a reduction of auto-antibodies in a treated patient.

##### EXAMPLE 3

The helper T-lymphocyte subsets TH1 and TH2 have been measured in 13 normal control volunteers and in two

patients suffering from the autoimmune disease scleroderma. The ratio of TH1:TH2 in the controls, as measured by intracellular cytokine flow cytometry, was found to be 3.029+/-0.639 (mean +/- standard deviation). The patients with scleroderma had TH1:TH2 ratios of 5.0 and 4.58 respectively, most likely, indicating an increase in the TH1 population relative to the TH2 population. In inflammatory pathologies such as many autoimmune diseases there is a relative increase in the TH1 cells; therefore it was to be expected that this ratio would be higher in these patients than in the healthy control individuals.

Following a course of therapy with blood treated according to the invention (i.e. the autovaccine described herein), the TH1:TH2 ratios in these patients was 3.29 and 3.13 respectively, i.e. the ratio had approached the normal range. These data suggest that therapy with blood treated according to the present invention may reduce an autoimmune response as evidenced by a relative increase in the TH2 cells.

EXAMPLE 4

STAINING OF ACTIVATION MARKERS

This example illustrates an experimental approach which indicates that treatment of blood with UV/ozone according to the invention has an immune-stimulatory effect on human blood, as evidenced by an increase in certain activation markers on the surface of the treated mononuclear cells.

Samples (20 ml) of peripheral blood were taken from individuals. Each sample was divided into two aliquots. The first aliquot was treated according to the inventive technique, as follows:

The 10 ml aliquot was treated in vivo for three minutes with ozone gas (variable ozone concentration of 5-50 µg/ml) and ultraviolet light (253.7 nm), at a temperature of 42.5° C. An apparatus similar to that disclosed in U.S. Pat. No. 4,968,483 was utilized to carry out the treatment of the blood sample.

The second 10 ml aliquot from each sample served as an untreated control.

Each blood sample was stained for certain activation markers of T-lymphocytes using conventional monoclonal antibody techniques. The proportion of the total cells which stained positive for the individual markers was quantitated by microscopy. The results are as follows:

Marker	Control	Ozone/UV Treated
CD25 (IL-2 receptor)	1%	26%
CD2 (E-rosette receptor)	3%	33%

The above data for this example are all means of duplicates, and indicate that treatment with UV/ozone according to the invention results in the activation of T-lymphocytes.

I claim:

1. A process of treating a mammalian patient suffering from an autoimmune disease, to alleviate the symptoms thereof, which comprises:

extracting an aliquot of blood from a patient; modifying the extracted blood aliquot extracorporeally by subjecting it to an immune system-modifying amount of ozone gas and ultraviolet radiation, so as to create in the blood aliquot, in comparison with an equal volume aliquot of said patient's unmodified blood, at least one of the following distinguishing features:

- (a) increased numbers of leukocytes exhibiting a condensed apoptotic-like morphology;
- (b) a reduction in the number of leukocytes expressing the MHC Class II leukocyte cell surface specific protein HLA-DR;
- (c) an upregulated expression on leukocytes of the CD-11b cell surface marker and re-injecting the blood aliquot so modified into said patient.

2. The process of claim 1 wherein the aliquot size is from 0.01-400 ml.

3. The process of claim 2 wherein the aliquot size is from 1-50 ml.

4. The process of claim 1 wherein the ozone gas and ultraviolet radiation are applied to the blood aliquot simultaneously, whilst the blood aliquot is at a temperature of from 37-55° C.

5. The process of claim 1 wherein the ozone is administered as a gas stream in admixture with medical grade oxygen, the ozone content therein being from 0.5-100 µg/ml, at a rate of from 0.01-2.0 liters per minute (STP), over a period of 0.5-60 minutes.

6. The process of claim 1 wherein the ultraviolet radiation is supplied from at least one ultraviolet lamp emitting in the C-band wavelength.

7. The process of claim 1 wherein the ultraviolet radiation is obtained from ultraviolet lamps emitting at least about 90% of ultraviolet radiation of a wavelength about 253.7 nm.

8. The process of claim 5 wherein the blood aliquot is treated with ozone and ultraviolet radiation at a temperature from 37-43° C., for a period of from 2-5 minutes, the ozone/oxygen mixture being supplied at a rate of from 0.1-1.0 liters per minute, with an ozone content of from 5-50 µg/ml.

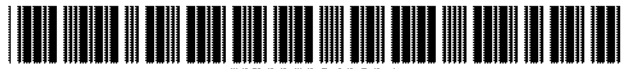
9. The process of claim 1 wherein the autoimmune disease is arthritis.

10. The process of claim 8 wherein the autoimmune disease is rheumatoid arthritis.

11. The process of claim 1 wherein the autoimmune disease is scleroderma.

12. The process of claim 1 wherein the extracted blood aliquot is extracorporeally treated so as to additionally create in the patient's peripheral blood after re-injection, in comparison with said patient's unmodified peripheral blood, a decrease in the ratio of TH1:TH2 cells.

\* \* \* \* \*



US005834030A

**United States Patent** [19]  
**Bolton**

[11] **Patent Number:** **5,834,030**  
[45] **Date of Patent:** **\*Nov. 10, 1998**

[54] **METHOD OF INCREASING THE CONCENTRATION OF NITRIC OXIDE IN HUMAN BLOOD**

5,052,382 10/1991 Wainwright ..... 128/202  
5,547,635 8/1996 Duthie, Jr. .... 422/24  
5,591,457 1/1997 Bolton ..... 424/613

[75] Inventor: **Anthony E. Bolton**, Sheffield, Great Britain

**FOREIGN PATENT DOCUMENTS**

1 068 428 5/1957 Germany .

[73] Assignee: **Vasogen, Inc.**, Ontario, Canada

**OTHER PUBLICATIONS**

[\*] Notice: The term of this patent shall not extend beyond the expiration date of Pat. No. 5,591,457.

Snyder et al., "Biological Roles of Nitric Oxide", Scientific American, May 1992, pp. 68-77.

Bredt et al., "Cloned and Expressed Nitric Oxide Synthase Structurally Resembles Cytochrome P-450 Reductase", Nature, vol. 351, Jun. 1991, pp. 714-718.

[21] Appl. No.: **477,818**

Ozone: "Historical Review", published in Biomedical Technology Dec. 1991.

[22] Filed: **Jun. 7, 1995**

British Medical Journal, vol. 296, Jan. 1988, pp. 330-331 entitled "Secondary Prevention of Vascular Disease by Prolonged Antiplatelet Treatment".

**Related U.S. Application Data**

[63] Continuation-in-part of Ser. No. 941,326, Sep. 4, 1992, abandoned, which is a continuation-in-part of Ser. No. 832,798, Feb. 7, 1992, abandoned.

Mueller Medical International Inc., Technical Report and Clinical Update, Shannon, et al., Oakville, Canada, Jun. 1990.

[51] **Int. Cl.**<sup>6</sup> ..... **A61K 33/00**; A61K 35/14; A61K 41/00; A61L 2/10

Chemical Abstracts 110: 121366, 1989.

Chemical Abstracts 122:38939, 1995.

[52] **U.S. Cl.** ..... **424/613**; 424/529; 424/718; 422/24; 422/44; 422/45; 422/46; 514/929; 435/2; 604/4; 604/20; 604/25

Embase Abstract, Accession No. 1998031574, 1998.

[58] **Field of Search** ..... 424/613, 718, 424/529; 422/24, 45, 44, 46; 604/4, 20, 25; 250/493.1; 435/2; 514/929

*Primary Examiner*—John Pak

*Attorney, Agent, or Firm*—Nixon & Vandertuyne

[56] **References Cited**

[57] **ABSTRACT**

**U.S. PATENT DOCUMENTS**

695,647 3/1902 Smith ..... 604/25  
3,715,430 2/1973 Ryan ..... 424/127  
4,632,980 12/1986 Zee et al. .... 530/380  
4,831,268 5/1989 Fisch et al. .... 250/432  
4,968,483 11/1990 Muller et al. .... 422/45  
4,983,637 1/1991 Herman ..... 514/724

A method of increasing the nitric oxide concentration in the blood of a human, which comprises: (a) contacting from about 0.01 ml to about 400 ml of blood with a nitric oxide concentration-increasing effective amount of ozone gas and ultraviolet radiation; and (b) administering the treated blood to a human. The method of the invention is useful for treating a variety of conditions benefitted by increased blood levels of nitric oxide.

**12 Claims, No Drawings**



## METHOD OF INCREASING THE CONCENTRATION OF NITRIC OXIDE IN HUMAN BLOOD

### CROSS-REFERENCE TO RELATED APPLICATIONS

This application is a continuation-in-part of U.S. patent application Ser. No. 07/941,326, filed on Sep. 4, 1992, now abandoned, the entire disclosure of which is incorporated herein by reference, which is in turn a continuation-in-part of U.S. patent application Ser. No. 07/832,798 (now abandoned) filed Feb. 7, 1992, the entire disclosure of which is incorporated herein by reference.

### BACKGROUND OF THE INVENTION

#### 1. Field of the Invention

This invention relates to methods of increasing the concentration of nitric oxide in human blood, and to methods of therapeutically treating human disease conditions associated with reduced in vivo blood levels of nitric oxide.

#### 2. Description of the Prior Art

Platelets are the smallest of the formed elements of the blood. Every cubic millimeter of blood contains about 250 million platelets, as compared with only a few thousand white cells. There are about a trillion platelets in the blood of an average human adult. Platelets are not cells, but are fragments of the giant bone-marrow cells called megakaryocytes. When a megakaryocyte matures, its cytoplasm breaks up, forming several thousand platelets. Platelets lack DNA and have little ability to synthesize proteins. When released into the blood, they circulate and die in about 10 days. However, platelets do possess an active metabolism to supply their energy needs.

Because platelets contain a generous amount of contractile protein (actomyosin), they are prone to contract much as muscles do. This phenomenon explains the shrinkage of a fresh blood clot after it stands for only a few minutes. The shrinkage plays a role in forming a hemostatic plug when a blood vessel is cut. The primary function of platelets is that of forming blood clots. When a wound occurs, platelets are attracted to the site where they activate a substance (thrombin) which starts the clotting process. Thrombin, in addition to converting fibrinogen into fibrin, also makes the platelets sticky. Thus, when exposed to collagen and thrombin, the platelets aggregate to form a plug in the hole of an injured blood vessel.

Platelets not only tend to stick to one another, but to the walls of blood vessels as well. Because they promote clotting, platelets have a key role in the formation of thrombi. The dangerous consequences of thrombi are evident in many cardiovascular and cerebrovascular disorders.

The precise function of blood platelets in various human disease states has recently become increasingly understood as advances in biochemistry permit the etiologies of diseases to be better understood.

For example, many attempts have been made to explain the process of atherogenesis, that is, the creation of plaque which narrows arteries and, of particular concern, the coronary arteries. Recently, there has been increasing interest in the possible role of platelets in atherosclerosis.

In this regard, there is a growing body of evidence that nitric oxide (NO) in the blood exercises various biochemical functions. As the precise biological role of nitric oxide has been explored, it has become known that nitric oxide serves as an important messenger molecule in the brain and other

parts of the body, governing diverse biological functions. In blood vessels, the principal endothelium-derived relaxing factor (EDRF) is believed to be nitric oxide, which stimulates vasodilation. Nitric oxide also inhibits platelet aggregation and is partially responsible for the cytotoxic actions of macrophages.

In the brain, nitric oxide mediates the actions of the excitatory neurotransmitter glutamate in stimulating cyclic GMP concentrations. Immunohistochemical studies have localized nitric oxide synthase (NOS) to particular neuronal populations in the brain and periphery. Inhibitors of nitric oxide synthase block physiological relaxation of the intestine induced by neuronal stimulation, indicating that nitric oxide has the properties of a neurotransmitter. In this regard, nitric oxide appears to be a novel type of neuronal messenger, in that, unlike conventional neurotransmitters, nitric oxide is not stored in synaptic vesicles and does not act on typical receptor proteins of synaptic membranes. One function of nitric oxide may be to protect neurons from ischemic and neurotoxic insults. See, Bredt et al., "Cloned and Expressed Nitric Oxide Synthase Structurally Resembles Cytochrome P-450 Reductase," *Nature*, Vol. 351, June, 1991, pages 714-718.

Thus, in addition to platelet aggregation associated diseases, a number of other disease states in humans are presently believed to be associated with inadequate nitric oxide levels in the blood. These nitric oxide associated conditions include: high blood pressure, neurological conditions such as depression, tumors, bacterial and fungal infections, and impotence.

It would therefore be desirable to provide a method for increasing the nitric oxide concentration in human blood, in order to treat the above-described human disease states which are characterized by nitric oxide deficiency.

A separate body of prior art discloses various methods of using ozone gas to treat certain human diseases, wounds and infections.

U.S. Pat. No. 695,657 to Smith discloses a portable ozonizer for the treatment of wounds. The device includes an ozonizer housed in a glass jacket, one end of which receives an air-supply tube and other end of which functions as an outlet tube for the ozonized air. The device enables topical application of ozone gas, which is said to be used to treat suppurating or gangrenous surfaces.

U.S. Pat. No. 3,715,430 to Ryan relates to a method and apparatus for producing substantially pure oxygen having a controlled content of ozone and higher oxygen polymers. The purified oxygen gas is exposed to ultraviolet light in a wavelength of 2485 to 2537 angstrom units in order to produce 5 to 500 parts per million of ozone and higher oxygen polymers in the gas mixture. Ryan indicates that the gas produced in this manner is non-irritating to the human body and may be intravenously injected into the blood stream for therapeutic use.

U.S. Pat. No. 4,632,980 to Zee et al. discloses a method of freeing blood and blood components of enveloped viruses by contacting the blood or blood product in an aqueous medium with an enveloped virus inactivating amount of ozone. The treatment is carried out at a temperature of 4° C. to 37° C., and an ozone concentration of 1-100 ppm. The disclosed process is said to be useful for inactivating the hepatitis virus, HTLV-I, -II, and -III, and influenza virus.

U.S. Pat. No. 4,831,268 to Fisch et al. provides a method for the radiation of corporeal blood to prevent arteriosclerosis related heart and vascular diseases caused by disturbances in the fat exchange. The disclosed process involves

irradiating the blood in a blood conducting tube with radiation having an intensity of from about  $1 \text{ mWcm}^{-2}$  to  $10 \text{ mWcm}^{-2}$  in a wavelength range of from about 320 nm to 600 nm.

U.S. Pat. No. 4,968,483 to Muller et al. discloses an apparatus for the production of oxygenated blood. The apparatus includes a vessel for containing the blood to be processed, an ultraviolet lamp and infrared lamp associated with the vessel, and a feed pipe extending into the vessel to a position near the bottom of the vessel, in which the feed pipe is connected to a source of ozone.

U.S. Pat. No. 4,983,637 to Herman relates to a method of treating systemic viral infections by the parenteral administration of pharmacologically effective amounts of ozonides of terpenes in pharmaceutically acceptable carriers. The disclosed method is particularly directed to the treatment of HIV infections.

U.S. Pat. No. 5,052,382 to Wainwright discloses an apparatus for the controlled generation and administration of ozone. The apparatus includes a generator for generating ozone, a monitor for monitoring the ozone production, a dosage device for providing a predetermined amount of ozone administration, and a computer control device for controlling the operation of the apparatus. The patent further discloses that administration of ozone to patients is known for the treatment of viral and bacterial infections, as well as for the treatment of external sores and wounds.

#### SUMMARY OF THE INVENTION

Applicant has unexpectedly discovered that in vitro nitric oxide concentrations in human blood may be raised by contacting from 0.01 ml to about 400 ml of blood with nitric oxide concentration-increasing effective amount of ozone gas and ultraviolet radiation.

The invention also contemplates a method of treating a condition in a human, by contacting from about 0.01 ml to about 400 ml of blood with nitric oxide concentration-increasing effective amount of ozone gas and ultraviolet radiation, followed by administration of the blood so treated to a human.

#### DESCRIPTION OF THE PREFERRED EMBODIMENTS

The present invention provides a method of increasing the nitric oxide concentration in the blood of a human, which comprises:

- (a) contacting from about 0.01 ml to about 400 ml of blood with a nitric oxide concentration-increasing effective amount of ozone gas and ultraviolet radiation; and
- (b) administering the blood treated in step (a) to a human.

Examples 1 and 2 below show that an inhibition of blood platelet aggregation can only be achieved when the blood is treated with a combination of ozone gas and ultraviolet radiation (UV). Treatment of blood solely with ozone gas produces minimal inhibition of blood platelet aggregation. Treatment of blood solely with ultraviolet light produces no inhibition of platelet aggregation whatsoever. Moreover, Examples 3 and 4 show that the inhibition of blood platelet aggregation proceeds via a nitric oxide mediated mechanism, and that treatment of blood with ultraviolet light and ozone according to the invention increases nitric oxide concentrations in the blood. Example 5 shows that reinjection of such nitric oxide-enriched blood, so treated, into the human body enhances blood flow due to creation of a greater level of available nitric oxide in the blood vessels.

The combined treatment with ozone gas and ultraviolet light has therefore been unexpectedly found to produce a notable increase in the blood concentration of nitric oxide, which may be useful in treating a variety of disorders that are benefitted by increased blood levels of nitric oxide.

The ozone gas may be provided by any conventional source known in the art, such as an ozonizer. The ozone gas used in connection with the inventive method has a concentration of ozone of from about 0.5 to about  $100 \mu\text{g/ml}$ . Preferably, the ozone gas has a concentration of from about 5 to about  $50 \mu\text{g/ml}$ . The ozone gas is preferably delivered to the blood by means of a medical oxygen carrier, and is preferably contacted with the blood by any means known in the art, preferably by bubbling the ozone/oxygen mixture through the blood sample.

The ultraviolet radiation may be provided by any conventional source known in the art, for example by a plurality of low-pressure ultraviolet lamps. The invention preferably utilizes a standard UV-C source of ultraviolet radiation. Preferably employed are low-pressure ultraviolet lamps that generate a line spectrum wherein at least about 90% of the radiation has a wavelength of about 253.7 nm. It is believed that ultraviolet radiation having emission wavelengths corresponding to standard UV-A and UV-B sources would also provide acceptable results.

The blood to be treated with UV/ozone is preferably heated to a temperature of from about  $0^\circ$  to about  $56^\circ \text{C}$ . while being contacted with the ozone gas and ultraviolet radiation. Any suitable source of heat known in the art may be employed to heat the blood, preferably one or more infrared lamps. The blood may be heated to about  $37^\circ$ – $43^\circ \text{C}$ ., most preferably about  $42.5^\circ \text{C}$ ., prior to being contacted with the ozone gas and ultraviolet radiation. Preferably, the temperature of the blood is then maintained at about  $42.5^\circ \text{C}$ . during the treatment with UV/ozone.

Alternatively, the blood sample is heated while being subjected to UV radiation, until the blood reaches a predetermined temperature (preferably about  $42.5^\circ \text{C}$ .), at which point bubbling of ozone gas through the blood is commenced. The concurrent UV/ozone treatment is then maintained for a predetermined period of time, preferably about 3 minutes.

Another alternative method involves subjecting the blood to UV/ozone while heating the blood to a predetermined temperature (preferably about  $42.5^\circ \text{C}$ .), then either ending the treatment once the predetermined temperature is reached, or continuing UV/ozone treatment for a further period of time, most preferably about 3 minutes.

Heating the blood to about  $42.5^\circ \text{C}$ . with the infrared lamps preferably employed according to the invention has been found to take from about one minute and fifty seconds to about two minutes and ten seconds.

It will be understood that the source of blood treated according to the invention may be blood from an outside source, such as a blood donor of compatible blood type, which is treated with UV/ozone and then administered to a patient. Alternately, and preferably, the blood to be treated may be withdrawn from the human patient as an aliquot, treated with UV/ozone, then readministered to the patient from whom the aliquot of blood was taken. All or a portion of the blood removed from the patient may be treated and then readministered to the patient.

In general, from about 0.01 to about 400 ml of blood may be treated according to the invention. Preferred amounts are in the range of about 0.1 to 200 ml, and more preferably from about 1 to 50 ml of blood. The method most preferably involves treating about 10 ml of blood with ozone gas and

ultraviolet radiation, then administering (or readministering) the treated blood to the patient by intramuscular injection.

Other conventional techniques known in the art for administering blood may be employed, such as inter-arterial injection, intravenous injection, subcutaneous injection, and intraperitoneal injection. The administration of small volumes of host blood in this fashion is termed micro-auto-hemotherapy.

The invention also contemplates an embodiment wherein blood is continuously removed from a patient's body and circulated through an apparatus which treats the blood with ozone gas and ultraviolet light as described above, before returning the blood to the patient. This procedure would have particular utility, for example, during the performance of operative procedures, such as coronary bypass surgery.

The blood is contacted with the ozone gas and ultraviolet radiation for a period of time sufficient to effectively raise the nitric oxide blood concentration in the patient. A treatment period of from about a few seconds to about 60 minutes, preferably from about 0.5 minutes to about 10 minutes, and most preferably about 3 minutes, has been found to provide satisfactory increase in nitric oxide blood levels. The blood is preferably maintained at a temperature of about 42.5° C. during the three minute treatment period.

The method should be carried out under sterile conditions known to those of ordinary skill in the art. The method of the invention may be carried out using conventional apparatus for ozonating blood and irradiating blood with ultraviolet radiation known to those skilled in the medical art. Preferably, an apparatus similar to that disclosed in U.S. Pat. No. 4,968,483 is employed to carry out the method of the invention. The disclosure of U.S. Pat. No. 4,968,483 is incorporated herein in its entirety by reference.

In a preferred aspect of the invention, a method of increasing the nitric oxide concentration in the blood of a human is provided, which comprises:

(a) contacting from about 0.01 ml to about 400 ml of blood with nitric oxide concentration-increasing effective amount of ozone gas supplied in a concentration from about 5 µg/ml to about 50 µg/ml of ozone gas in an oxygen containing gas stream and ultraviolet radiation having a wavelength of about 253.7 nm, while maintaining the blood at a temperature of from about 37° C. to about 43° C.; and

(b) administering the treated blood to a human.

The invention also contemplates a method of treating a condition in a human, which comprises:

(a) contacting from about 0.01 ml to about 400 ml of blood with a nitric oxide concentration-increasing effective amount of ozone gas and ultraviolet radiation; and

(b) administering the treated blood to a human.

The useful and preferred ranges of ozone concentration, ultraviolet wavelength, temperature, and other parameters of the method of treatment are the same as described above with regard to the method of increasing nitric oxide blood concentration.

Those skilled in the art will appreciate that the method of increasing nitric oxide blood concentration provided by the invention will have therapeutic utility for treating a wide range of disease states which may be benefitted by increasing the levels of nitric oxide in the blood.

The term "treating" as used herein refers to the alleviation or prevention of a particular disorder. In the case of traumatic conditions such as stroke, preventative treatment is obviously preferred.

The following diseases are illustrative of known conditions which are potentially treatable according to the inven-

tive method: high blood pressure; neurological conditions such as depression; tumors; bacterial, viral, protozoal, and fungal infections and impotence. This list is merely illustrative; those of ordinary skill in the art will appreciate that other disease states benefitted by increasing the concentration of nitric oxide in the blood may be treated with the inventive technique.

The treatment of peripheral vascular disease with UV/ozone gas is described in grandparent application Ser. No. 07/832,798 filed on Feb. 7, 1992, which is now abandoned. The vascular bed of the body is considered to be a single system, and hence any treatment for peripheral vascular disease will be effective for similar pathologies found in all other parts of vascular system e.g. the heart (cardiovascular disease) and the brain (cerebrovascular disease, a cause of stroke). Peripheral vascular disease (PVD) is thought to be associated with a reduction of endothelial-derived relaxing factor (EDRF), low levels of which lead to a concentration of the smooth muscle of blood vessels, and hence a reduction in the diameter of the lumen of the vessel and a reduction in blood flow. The major naturally occurring EDRF is nitric oxide. In addition, nitric oxide stabilizes blood platelets, reducing their aggregation. An increase in EDRF (nitric oxide) levels, therefore, has a double beneficial effect on the circulatory system: it inhibits aggregation of platelets, making the blood more fluid, and it enlarges the diameter of the vessels, improving the flow. The reverse, a reduction in nitric oxide levels, may be present in peripheral vascular disease, and the other conditions described above which may be benefitted by increasing the blood concentration of nitric oxide.

As illustrated in the examples below, the method of the invention is believed to increase nitric oxide levels in the blood, which may explain the mode of action in the inventive treatment of peripheral vascular disease and other conditions associated with blood platelet aggregation and nitric oxide deficiency.

The following examples are given to illustrate the invention but are not deemed to be limiting thereof.

#### EXAMPLE 1

##### INHIBITION OF BLOOD PLATELET AGGREGATION

The following experiment was conducted to study the effects of ozone/ultraviolet light treatment on blood platelet activity.

##### EXPERIMENTAL PROCEDURE

Samples (20 ml) of peripheral blood were taken from 10 individuals for 13 separate experiments. Each sample was divided into two aliquots. The first aliquot was treated according to the inventive technique, as follows:

The 10 ml aliquot was treated in vitro for three minutes with ozone gas (variable ozone concentration of 5-50 µg/ml) and ultraviolet light (253.7 nm), at a temperature of 42.5° C. An apparatus as disclosed in U.S. Pat. No. 4,968,483 was utilized to carry out the treatment of the blood sample.

The second 10 ml aliquot from each sample served as an untreated control.

Platelets were isolated from the control or treated samples by centrifugation, and their ability to aggregate in response to different concentrations of ADP (a natural platelet stimulator) was measured in an aggregometer. A sample of both ozone-treated and untreated blood was used for quantitation of platelet numbers, using a Coulter counter. In some

of the experiments described below, aliquots of the blood were treated with different concentrations of ozone. In other experiments performed, the blood was treated in the presence and absence of UV-light irradiation.

In the reported data, control samples were assigned a number of 100 for platelet aggregation and platelet aggregation in the ozone-treated blood was expressed as a percentage of this 100% aggregation in the same person untreated control blood.

## RESULTS

As shown in Table 1, the results of the experiments indicate that treatment of blood with ozone and ultraviolet light according to the invention inhibits the aggregation of blood platelets. Furthermore, there is an indication that this inhibition is dose related to the ozone concentration (see Table 2).

### THE EFFECT OF HIGH LEVELS OF OZONE ON ADP-STIMULATED BLOOD PLATELETS

High levels of ozone (between 35 and 50  $\mu\text{g}/\text{ml}$ ) caused a measurable inhibition of ADP-induced platelet aggrega-

tion (arbitrarily taken as 33.3% inhibition) in 11 of the 13 experiments (8 of the 10 individuals). Taking all the data on all 10 individuals, the mean inhibition of platelet aggregation was  $49.2 \pm 27.8\%$  (mean  $\pm$  sd). There was no significant difference between the inhibitory effects on blood taken from males and females (mean inhibition 48.1% and 50.7%, respectively).

This inhibition appears to relate to the concentration of ADP (aggregation stimulator) over the concentration range of 0.01–0.1 mM ADP, with lower inhibition at higher concentrations of platelet agonist. However, this relationship did not hold at higher ADP concentrations (Table 1) and could be spurious, although the level of inhibition at 0.01 mM ADP is significantly greater than at 0.1 mM ADP (71% vs. 95%,  $p < 0.02$ ).

TABLE 1

The effect of high levels of ozone on the aggregation of human blood platelets in the presence of varying concentration of ADP.

Date (Individual)	Concentration of ozone ( $\mu\text{g}/\text{ml}$ )	Concentration of ADP (mM)	Percent Inhibition of Aggregation	Platelet Count	
				Before Ozone	After Ozone
21.11.91 (F1)	50	10	100	(i.e. no aggregation)	
27.11.91 (M1)	50	5	83.3		
		10	71.4		
		30	75.0		
2.12.91 (F2)	50	10	0	(i.e. aggregation as with control)	
		30	10.0		
		100	27.3		
3.12.91 (M2)	50	0.5	67.1		
		1	57.1		
		5	50.0		
		30	88.1		
6.12.91 (M3)	50	0.1	0	34	49
		0.1	6.2		
		0.5	4.0		
		0.5	0		
11.12.91 (M4)	50	0.05	67.0	56	93
		0.1	62.4		
		1.0	74.3		
		10.0	50.0		
12.12.91 (M5)	50	0.01	67.0	51	121
		0.1	7.1		
		1.0	35.7		
		0.01	63.4		
		0.05	22.7		
13.12.91 (F1)	50	0.1	30.4	33	87
		0.5	15.4		
		1.0	20.8		
		5.0	20.0		
		10.0	27.6		
		0.01	34.2		
		0.05	31.0		
		0.1	9.8		
9.01.92 (M6)	50	0.5	15.4	34	40
		1.0	26.2		
		5.0	31.3		
		0.001	71.4		
		0.005	37.5		
		0.01	69.8		
10.01.92 (F3)	50	0.05	33.8	49	64
		0.1	31.2		
		0.5	10.1		
		1.0	21.8		
		0.01	69.8		
		0.05	33.8		

-continued

13.01.92 (F4)	50	0.005	100	49	52
		0.01	100		
		0.05	95.2		
		0.1	92.9		
		0.5	95.8		
		1.0	91.6		
		5.0	95.8		
		10.0	80.0		
15.01.92 (F1)	40	0.01	90.0	81	66
		0.05	71.4		
		0.1	40.7		
		0.5	87.0		
		1.0	81.8		
		5.0	95.5		
		10.0	85.2		
		50.0	84.0		
		100.0	79.1		
21.01.92 (M2)	35	0.01	67.1	68	79

The following is a summary of the data set forth in Table 1.

ADP mM	0.01	0.05	0.10	0.50	1.00	5.00	10.0
% Inhibition of Aggregation	70.8 +/- 20.9	53.5 +/- 26.1	34.7 +/- 28.4	37.6 +/- 38.4	50.3 +/- 28.7	60.7 +/- 35.2	60.7 +/- 30.4
N =	6	6	8	7	7	4	4

#### THE EFFECT OF HIGH LEVELS OF OZONE ON TOTAL WHOLE BLOODPLATELET COUNTS

As any apparent reduction in platelet aggregation following ozone treatment of whole blood could be caused by a loss of platelets from the blood during treatment, total whole platelet counts were performed on the treated and untreated whole blood samples in 9 experiments on blood from 8 individuals. Overall, the platelet count was  $115.5 \pm 59.8\%$  of the untreated level following ozonization (range 82–264%).

Thus, the total platelet counts before and after ozone/UV treatment do not indicate a major loss of platelets from the blood as a result of ozonization.

#### THE EFFECT OF DIFFERENT CONCENTRATIONS OF OZONE ON THE INHIBITION OF AGGREGATION OF HUMAN BLOOD PLATELETS STIMULATED WITH ADP

Three different concentrations of ozone (5, 25, and 50  $\mu\text{g}/\text{ml}$ ) were used at a range of ADP concentrations in 4 experiments on 4 different individuals. Bulking the data for different ozone concentrations from each individual and calculating the mean for the data from the 4 experiments indicated that there was some dose response relationship between the concentration of ozone used and the inhibition of platelet aggregation (See Table 2).

Although overall these differences were not significant, in two of the four individuals there was a significantly greater inhibitory effect of ozone at 50  $\mu\text{g}/\text{ml}$  than at 5  $\mu\text{g}/\text{ml}$  (See Table 3).

TABLE 2

The effect of different concentrations of ozone on inhibition of platelet aggregation in the presence of ADP.

Date (Individual)	Concentration of Ozone ( $\mu\text{g}/\text{ml}$ )	Concentration of ADP (mM)	Percent	
			Inhibition of Aggregation	Platelet Count Before Ozone After Ozone
3.12.9 (M2)	15	0.1	27.3	
	25	0.1	100	
	5	0.5	0	
	25	0.5		
	50	0.5	67.1	
	5	1.0	0	
	25	1.0	28.6	
	50	1.0	57.1	
	5	5.0	0	
	25	5.0	25.0	
	50	5.0	50.0	
	5	30.0	50.0	
	25	30.0	62.0	
	50	30.0	88.1	

TABLE 2-continued

The effect of different concentrations of ozone on inhibition of platelet aggregation in the presence of ADP.					
9.01.92 (M6)	5	0.01	20.1	34	43
	25	0.01	28.9		
	50	0.01	34.2		
	5	0.05	0		
	25	0.05	5.2		
	50	0.05	31.0		
	5	0.1	9.8		
	25	0.1	1.4		
	50	0.1	9.8		
	5	0.5	0		
	25	0.5	15.0		
	50	0.5	15.4		
	5	1.0	22.5		
	25	1.0	13.7		
	50	1.0	26.2		
	5	5.0	0		
25	5.0	17.8			
50	5.0	31.5			
10.01.92 (F3)	5	0.001	57.1	49	73
	25	0.001	85.7		
	50	0.001	71.4		
	5	0.005	37.5		
	25	0.005	80.0		
	50	0.005	37.5		
	5	0.01	66.4		
	25	0.01	83.2		
	50	0.01	69.8		
	5	0.05	44.9		
	25	0.05	66.9		
	50	0.05	33.8		
	5	0.1	29.3		
	25	0.1	61.0		
	50	0.1	31.2		
	5	0.5	39.4		
25	0.5	54.5			
50	0.5	10.1			
5	1.0	21.8			
25	1.0	52.9			
50	1.0	21.8			
13.01.92 (F4)	5	0.005	100	49	60
	25	0.005	100		
	50	0.005	100		
	5	0.01	100		
	25	0.01	87.5		
	50	0.01	100		
	5	0.05	84.8		
	25	0.05	97.1		
	50	0.05	95.2		
	5	0.1	82.9		
	25	0.1	91.4		
	50	0.1	92.9		
	5	0.5	83.3		
	25	0.5	95.8		
	50	0.5	95.8		
	5	1.0	83.2		
25	1.0	89.5			
50	1.0	91.6			
5	5.0	79.2			
25	5.0	91.7			
50	5.0	95.8			
5	10.0	85.3			
25	10.0	80.0			
50	10.0	80.0			

The following is a summary of the data set forth in Table 2:

Concentration of ozone ( $\mu\text{g}/\text{ml}$ )	5	25	50
Platelet Aggregation (%) (mean $\pm$ sd, n = 4)	38.5 $\pm$ 30.9	56.5 $\pm$ 29.4	55.9 $\pm$ 26.4

TABLE 3

The effect of different concentrations of ozone on inhibition of platelet aggregation in two individuals.			
Concentration of ozone ( $\mu\text{g/ml}$ )	5	25	50
Platelet aggregation M2 (%)	15.5 +/- 20.2	53.9 +/- 30.0	65.6 +/- 14.4
Difference from 5 $\mu\text{g/ml}$		ns	p < 0.01
Platelet aggregation M6 (%)	8.7 +/- 9.6	11.2 +/- 10.2	24.7 +/- 9.0
Difference from 5 $\mu\text{g/ml}$		ns	p < 0.02

ns = not significant

### THE EFFECT OF UV LIGHT ON THE RESPONSE OF PLATELETS TO OZONE

The effect of ozone on the aggregation of human blood platelets was investigated at different concentrations of ADP, in the presence or absence of UV light. The results, shown in Table 4, indicate that, although there may be some platelet aggregation-inhibitory response to ozone alone, this is nearly always greater in the presence of UV light and the effect of UV light was highly significant ( $p < 0.001$ ) in this single experiment. This result was also repeated in a second experiment, using a single concentration of ADP (0.01 mM). The results of this second experiment are set forth in Table 5.

TABLE 4

The effect of UV light on the inhibition of ADP-induced platelet aggregation by ozone at a concentration of 40 $\mu\text{g/ml}$ . (Experiment date 15.01.92, individual F1).		
Concentration ADP (mM)	Inhibition of Platelet Aggregation (%)	
	+UV	-UV
0.01	90.0	60.0
0.05	71.4	0
0.1	40.7	40.7
0.5	87.0	0
1.0	81.8	0
5.0	95.5	19.4
10.0	85.2	18.5
50.0	84.0	16.0
100.0	79.1	4.2
Mean +/- sd	79.4 +/- 15.1	17.6 +/- 19.6 (p < 0.001)

TABLE 5

The effect of UV light on platelet aggregation induced by ADP (0.01 mM) in the presence or absence of ozone. (Experiment date 21.01.92, individual M2) Percent Inhibition of Platelet Aggregation		
Ozone 35 $\mu\text{g/ml}$ + UV	Ozone 35 $\mu\text{g/ml}$ - UV	No ozone, UV alone
83.4%	11.2%	0%

In summary, the results of Example 1 indicate that the *in vitro* treatment of an aliquot of blood with ozone gas and ultraviolet light inhibits the aggregation of blood platelets. This platelet inhibition has been found to be dose related to the ozone concentration. Further, platelet inhibition was found to critically depend on the combined treatment of ultraviolet light and ozone gas, as evidenced in Tables 4 and

5. Treatment with ozone gas alone resulted in minimal inhibition of platelet aggregation, while treatment with ultraviolet light alone produced no inhibition of platelet aggregation.

### EXAMPLE 2

#### MEASUREMENT OF NITRIC OXIDE

In order to elucidate the mechanism whereby ozonization/UV light affects the aggregation of platelets in treated blood, the concentration of certain oxidized forms of nitrogen were measured.

The direct measurement of nitric oxide is difficult to achieve. However, nitric oxide is an intermediate in a metabolic pathway in which arginine is converted to citrulline, which is accompanied by the production of other stable end-products including thiol-nitric oxide (nitrite) complexes, metal-thiol-nitric oxide (nitrite) complexes and oxidized forms thereof i.e. nitrates.

Accordingly, the nitric oxide content for several samples of blood treated with ultraviolet light and ozone gas according to Example 1 were indirectly determined by measuring the combined nitrite plus nitrate concentrations in the samples before and after treatment with ozone/UV light, after converting nitrate to nitrite.

The results show that there is a small increase in nitrate plus nitrite concentrations after treatment according to the invention. This increase was consistently found in samples treated with ozone gas/UV light. Thus, nitric oxide levels appear to be enhanced by the treatment with ozone gas/UV light, and this appears to be part of the mode of action by which an inhibition of blood platelet aggregation is achieved by the invention. This therapeutic effect is consistent with the etiology of peripheral vascular disease described above.

#### CONCLUSIONS

The data of Examples 1 and 2 suggest that the treatment of blood with ozone gas and ultraviolet light according to the invention is actually inducing an inhibition of platelet aggregation for the following reasons:

1. The inhibitory effect is at least partially dependent on the concentration of ADP, ozone being more inhibitory at lower ADP concentrations. This may be interpreted as the higher agonist concentrations partially overcoming the inhibitory effect of ozone by "hyperstimulating" the platelets. This suggests that the inhibition is at least partially reversible, and is probably not acting by destroying the platelet's ability to aggregate.

2. The inhibitory effect appears to be dose related to ozone concentration, with higher concentrations of ozone resulting in a greater inhibition of platelet aggregation.

3. The inhibitory effect is UV-dependent, suggesting that this is not a non-specific toxic effect caused by the oxidative capacity of the ozone gas.

### EXAMPLE 3

Venous blood (20 ml), taken from 13 healthy non-smoking volunteers, 6 females and 7 males, age 20-50 years, was collected into sodium citrate anticoagulant. None of the volunteers had taken any medication for at least one week prior to the investigation. The blood was divided into two 10 ml aliquots. One aliquot was treated with ozone/UV as described below, the other was an untreated control sample.

#### OZONE TREATMENT OF BLOOD SAMPLES

Blood was treated according to the invention with different concentrations of ozone using a device similar to that

described in U.S. Pat. No. 4,968,483. Ozone in medical oxygen was bubbled through the blood sample at a rate of 0.3 l/min for a fixed period of about 3 minutes. The blood was heated to a temperature of 42.5° C. and exposed to ultraviolet light at a wavelength of 253.7 nm. The concentration of ozone in the oxygen carrier was variable between about 5 and 50 µg/ml, and was measured using an ozone monitor (Humares, Karlsruhe, Germany).

#### PLATELET AGGREGATION STUDIES

Platelet aggregation was measured essentially by the end point turbidimetric method of Born.

Platelet rich plasma (PRP) was prepared by centrifuging 10 ml of blood (either ozone-treated or untreated control blood) at room temperature for 20 minutes at 200 xg. Four ml of PRP was diluted by the addition of 1.0 ml of phosphate-buffered saline.

Diluted PRP (0.225 ml) was placed in an aggregometer cuvette containing a small magnetic stirrer bar (aggregometer model 1002, ADG Instruments Ltd., Codicote, Herts., U.K.) and equilibrated at 37° C. After stirring was commenced, 0.025 ml of agonist (either ADP—ADP platelet aggregation reagent; both from Sigma Chemical Co., Poole, Dorset, U.K.) was added to the final concentrations indicated in the results section below. The maximum change in light transmission was measured. Platelet aggregation in the ozone-treated samples was expressed as a percent of the aggregation in the control samples for each individual experimental condition.

Blood platelet counts were performed on whole blood, using a Coulter counter, provided by the Department of Hematology, Northern General Hospital, Sheffield, U.K.

#### RESULTS

Following treatment of whole blood with 35–50 µg/ml of ozone in oxygen at a flow rate of 0.3 l/min for 3 min (total mass of ozone reacted: 31.5–45 mg) with exposure to UV, there was an apparent overall increase in the platelet count, to 1461/57% (mean±/–standard deviation, range 81–202%) of the control value in the 12 individuals investigated. This suggests that, under the conditions used in these experiments, the treatment of whole blood with ozone does not destroy the blood platelets. Furthermore, following visual assessment, no marked hemolysis was observed in the treated blood compared with the control blood samples, indicating that the treatment regime had little effect on erythrocyte integrity.

Platelets from blood treated with a concentration of 35–50 µg/ml ozone as above showed a reduction in their ability to aggregate in response to ADP (0.001–100 mmol/l concentrations). The overall inhibition of aggregation was 53.1±/–31.1% (mean±/–standard deviation, n=13). The inhibition was variable between individuals, ranging from 2.6% to 100%.

This inhibitory effect of ozone/UV treatment was dependent on the concentration of ADP, showing a higher level of inhibition of platelet aggregation at low concentrations of ADP (See Table 6). The inhibitory effect at 0.01 mmol/l ADP was significantly greater (p<0.02) than at 0.1 mmol/l of this agonist (See Table 6).

With collagen as an inducer of platelet aggregation, platelets treated with 35–50 µg/ml ozone in oxygen also showed a high level of inhibition of aggregation: 74.2±/–43.3% with 1 mg/mol collagen and 76.4±/–25.2% with 10 mg/ml collagen (n=5).

A reduction in the concentration of ozone in the oxygen bubbled through the blood sample resulted in a reduction in the effect of treatment on the inhibition of platelet aggregation. This difference was significant in individual responses to treatment, although the overall mean values of the four individuals investigated were not significantly different (See Table 7).

TABLE 6

The effect of different concentrations of the platelet agonist ADP on the inhibition of ADP-induced platelet aggregation by treatment of blood in vitro with ozone at a concentration of 50 µg/ml in oxygen and UV irradiation.

Subject	Conc. ADP (mmol/l)	Percent Inhibition of Platelet Aggregation
Male 1	0.5	67.1
	1.0	57.1
	5.0	50.0
Female 1	0.001	71.4
	0.01	69.8
	0.1	31.2
	1.0	21.8
Female 2	0.01	63.4
	0.1	30.4
	1.0	20.8
Mean	0.01	70.8 ±/– 20.9, n = 6
	0.05	53.5 ±/– 26.1, n = 6
	0.1	34.7 ±/– 28.4, n = 8*

\*significantly different from 0.01 mmol/l, p < 0.02

TABLE 7

The effect of different concentrations of ozone on the inhibition of ADP-induced platelet aggregation by treatment of whole blood in vitro with ozone in oxygen and UV irradiation

Subject	Percent Inhibition of Platelet Aggregation		
	5 µg/ml Ozone	25 µg/ml Ozone	50 µg/ml Ozone
Male 1	15.5	53.9	65.6**
Male 2	8.7	11.2	24.7*
Mean (n = 4)	38.5	56.5	55.9
sd	30.9	29.4	26.4

\*\*significant at p < 0.01

\*significant at p < 0.02

#### EXAMPLE 4

#### THE EFFECT OF UV/OZONE TREATMENT OF BLOOD IN VITRO ON THE PLASMA NITRIC OXIDE CONCENTRATION

#### EXPERIMENTAL OUTLINE

Blood (10 ml), anticoagulated with sodium citrate, from 14 normal healthy individuals, was treated with UV/ozone gas as described in Example 3, with oxygen containing ozone at a concentration of 20–50 µg/ml. Control blood from each individual was not treated. After removal of the cellular components of the blood by centrifugation at 15 000xg for 30 seconds, the plasma was stored at –20° C.

Nitric oxide, produced metabolically from L-arginine, is unstable and reacts with oxygen to form nitrate and nitrite. Total nitrate plus nitrite was measured after conversion of nitrate to nitrite using a cadmium catalyst. Nitrite was measured colorimetrically using the Griess reagent by a



method based on that published by Green, Wagner, Glogowski, Skipper, Wishnok & Tannebaum in 1982 (*Analytical Biochemistry*, Vol. 126, pages 131-138). All treated and control samples were measured in a single assay run.

## RESULTS

The actual values of nitrite concentration varied widely between individuals, ranging from 0.6-27.6  $\mu\text{mol/l}$ . To enable comparisons between individuals, the concentration of nitrite in the ozone-treated sample was expressed as a percent of the concentration in the corresponding untreated control. A summary of the results is as follows:

Individual No.	Percent of Nitrite in Ozonated Sample Compared to Control
1	28.0
2	36.7
3	48.9
4	76.4
5	110.0
6	133.3
7	157.6
8	162.9
9	175.8
10	350.0
11	845.5
12	985.7
13	2075.0
14	3067.0
Arithmetic Mean	589.5%

These values do not form a normal distribution. However, an approximate normal distribution can be attained after logarithmic transformation of the data. Following logarithmic transformation, the level of nitrite in the UV/ozone-treated blood samples is significantly greater than in the untreated samples ( $p < 0.01$ ).

## INHIBITION STUDIES

Nitric oxide inhibits platelet aggregation—this is one of its physiological activities. It is known that the effect of nitric oxide on platelets can be inhibited by free oxyhemoglobin (Salvemini, Radziszewski, Korbut & Vane, *Br. J. Pharmacol.*; Vol. 101, pages 991-995, 1990). We therefore investigated the effect of oxyhemoglobin on the platelet aggregation inhibitory action of treatment of whole blood with UV/ozone gas.

## EXPERIMENTAL OUTLINE

Platelet rich plasma was prepared from whole blood, either treated with UV/ozone or untreated (control), by centrifugation at 200 $\times$ g for 20 minutes at room temperature. Platelet aggregation in response to ADP, collagen or thrombin as stimulators was measured in an aggregometer. Oxyhemoglobin was added to the platelet rich plasma subsequent to ozonization and before measuring platelet aggregation activity. If treatment of blood with UV/ozone to inhibit platelet aggregation is acting via a nitric oxide-mediated mechanism, then the addition of oxyhemoglobin should prevent the inhibition of platelet aggregation caused by UV/ozonization. The results are set forth in Table 8 below.

TABLE 8

Subject	Platelet Agonist	PERCENT INHIBITION OF PLATELET AGGREGATION AFTER OZONE/UV TREATMENT	
		No Hb	10 $\mu\text{mol/l}$ Hb
Female a	Thrombin 100 iu	23	4
Female b	Thrombin 100 iu	57	0
10	Thrombin 10 iu	97	57
	ADP 1 mmol/l	36	0
Male a	Thrombin 10 iu	80	79
	Collagen 1 mg/ml	95	80
	ADP 1 mmol/l	16	0
15	ADP 0.1 mmol/l	26	9

Although rather variable, two of the three subjects showed consistent reductions of post-UV ozone therapy platelet aggregation inhibition in the presence of haemoglobin, and the third subject showed some reduction with 3 of the 4 conditions of aggregation used. The overall means of platelet aggregation were 54% without haemoglobin and 29% in the presence of this inhibitor of nitric oxide activity.

## CONCLUSIONS

The above data show that ozonization of blood raises the level of nitrite (the stable metabolite of nitric oxide), and that the inhibition of platelet aggregation caused by ozonization of blood can be reversed by haemoglobin, an inhibitor of nitric oxide activity. Taken together, these data strongly suggest that the treatment of blood with UV/ozone according to the invention increases the in vivo blood levels of nitric oxide, and inhibits the aggregation of platelets via a nitric oxide mediated mechanism.

## EXAMPLE 5

### IN VIVO STUDIES

The effect of the administration of UV/ozone treated blood on patients with vascular disease.

## INTRODUCTION

It is known that in vivo nitric oxide has an effect on blood vessels, causing a relaxation of the muscle layer of the vessel wall resulting in vasodilation and an increase in the flow of blood through the vessel. Thus, evidence for an increase in nitric oxide production may be obtained from measurements of blood flow. However, the flow of blood through the vessels is controlled by complex interacting mechanisms and the measurement of basal blood flow will not reproducibly reflect effects of nitric oxide alone. Therefore, in order to examine the effect of nitric oxide, blood flow is measured in response to stimulating drugs which are known to be mediated via nitric oxide production. One such drug is acetyl choline which is known to stimulate the production of nitric oxide by the cells of the endothelium (blood vessel lining) thereby causing vasodilation and an increase in blood flow.

## EXPERIMENTAL OUTLINE

Blood (10 mL), anticoagulated with sodium citrate, was obtained from patients with a peripheral vascular disease and was treated in vitro with oxygen containing ozone at a concentration of 15  $\mu\text{g}$  ozone/mL oxygen, UV light at a wavelength of 253.7 nm at a temperature of 42.5° C. for three minutes utilizing an apparatus as disclosed in U.S. Pat.

No. 4,968,483. Following treatment, the blood was returned to the patient by intramuscular injection in the gluteal muscle. Each patient received 10 such individual treatments over a period of 2-4 weeks. A total of four patients was investigated.

Before and after the course of treatments described in the preceding paragraph, blood flow in the superficial blood vessels of the forearm were measured by a method combining laser Doppler blood flow measurements with the iontophoretic introduction of acetyl choline, using a commercially available device (DRT4 laser Doppler perfusion and temperature monitor and MIC 1 iontophoresis controller, from Moore Instruments Ltd., Axminster, Devonshire, UK). The blood flow resulting from the introduction of up to 36.2  $\mu\text{g}$  of acetyl choline was measured. In each case, this dose of acetyl choline gave a maximal response in terms of blood flow. The blood flow in response to this dose of acetyl choline was measured before and after the course of treatment with the in vitro treated blood in each patient, the results being expressed in units of blood flow.

### RESULTS

Before a course of treatment with the in vitro treated blood, the average blood flow in response to acetyl choline was 186.9 $\pm$ 34.4 units of blood flow (mean $\pm$ standard deviation). Following the course of 10 treatments as described above, the average blood flow in response to acetyl choline was 261.1 $\pm$ 106.0 units of blood flow (mean $\pm$ standard deviation). Thus, following the course of treatment, the blood flow in response to acetyl choline increased by an average of 39.7%.

### CONCLUSION

These results indicate that the blood flow in response to acetyl choline is increased after a course of treatment with in vitro treated blood. It is known that acetyl choline increases blood flow via nitric oxide generated using the intermediary effects of the endothelium. Hence, this provides evidence that there is a greater level of available nitric oxide in the blood vessel following treatment of a patient with the blood treated by the method of the invention, probably due to the effects of the re-injected treated blood (or some component of it) on the endothelium lining the blood vessels. Thus, not only does the treated blood aliquot of the present invention itself provide enhanced nitric oxide levels to the blood, for beneficial purposes, the treated aliquot of blood, after re-introduction into the blood stream of the human patient, itself stimulates generation of extra nitric oxide in the blood, by stimulation of endothelial action.

What is claimed is:

1. A method of inducing relaxation of the smooth muscle of blood vessels of a human patient to effect enlargement in the diameter of said blood vessels, which comprises the successive steps of:

- (a) extracting an aliquot of blood, of volume from about 0.01 ml to about 400 ml, from the human patient;
- (b) in vitro contacting the extracted aliquot of human blood with a nitric oxide concentration-increasing effective amount of ozone gas as an oxygen/ozone gas stream having an ozone concentration of from 0.5  $\mu\text{g}/\text{ml}$  to about 100  $\mu\text{g}/\text{ml}$ , and ultraviolet radiation, for a period of time from about 0.5-10 minutes and at a temperature, in the range 0 $^{\circ}$ -56 $^{\circ}$  C., which does not cause marked hemolysis in the blood aliquot or does not cause a major loss of platelets from the blood, to produce an aliquot of treated blood; and

(c) increasing the nitric oxide concentration in the blood of said patient by administering said treated blood to the same human patient.

2. The method of claim 1, wherein the ultraviolet radiation has a wavelength of about 253.7 nm.

3. The method of claim 1, wherein the aliquot of human blood in step (a) comprises about 10 ml of blood.

4. The method of claim 1, wherein the blood aliquot is contacted with the oxygen/ozone gas stream and ultraviolet radiation for a period of about 3 minutes.

5. The method of claim 1, wherein the treated blood is administered to the human by a method selected from the group consisting of inter-arterial injection, intramuscular injection, intravenous injection, subcutaneous injection, and intraperitoneal injection.

6. The method of claim 1 wherein the aliquot of blood in Step (a) has a volume from about 1-50 ml.

7. The method of claim 6 wherein the blood aliquot is maintained at a temperature of from about 37 $^{\circ}$ -43 $^{\circ}$  C. during the contact with ozone gas and ultraviolet radiation.

8. The method of claim 1, wherein the ultraviolet radiation is from a UV-C source of ultraviolet radiation.

9. A method of alleviating the symptoms of peripheral vascular disease in a human patient suffering therefrom, by increasing the nitric oxide concentration in the human patient's blood, which comprises the steps of:

(a) extracting an aliquot of blood, of volume about 0.1-200 ml, from the human patient;

(b) in vitro contacting the extracted aliquot of blood with a nitric oxide concentration-increasing effective amount of ozone gas, as a mixture of ozone in an oxygen-ozone gas stream having an ozone concentration of from about 0.5  $\mu\text{g}/\text{ml}$  to about 100  $\mu\text{g}/\text{ml}$ , while the aliquot of blood is simultaneously being subjected to ultraviolet radiation, for a period of time from about 0.5-10 minutes and at a temperature in the range of 0 $^{\circ}$ -56 $^{\circ}$  C. which does not cause marked hemolysis or major loss of platelets in the blood aliquot; and

(c) administering the treated aliquot of blood so obtained to said human patient so that stimulated leukocytes in said aliquot effect an increase in nitric oxide concentration in the human patient's blood.

10. The method of claim 9 wherein the blood aliquot is maintained at a temperature of from about 37 $^{\circ}$ -43 $^{\circ}$  C. during the contact with ozone and subjection to ultraviolet radiation.

11. A method of increasing the nitric oxide concentration in the blood of a human patient which comprises:

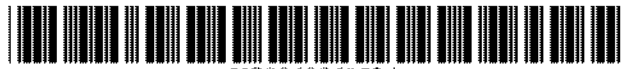
(a) extracting an aliquot of blood, of volume from about 0.01 ml to about 400 ml, from a human patient;

(b) in vitro contacting the extracted aliquot of human blood with a nitric oxide increasing amount of ozone gas and ultraviolet radiation for a period of time from about 0.5-10 minutes and at a temperature, in the range of 0-56 $^{\circ}$  C., which does not cause a marked hemolysis in the blood aliquot or does not cause a major loss of platelets from the blood, to produce an aliquot of treated blood;

(c) monitoring the increase in nitric oxide concentration in at least a portion of the aliquot of treated blood; and

(d) readministering at least a portion of the treated blood aliquot with increased nitric oxide concentration to the same human patient.

12. The method of claim 11 wherein the ozone gas is contacted with a blood aliquot as a mixture of ozone in an oxygen-ozone gas stream having an ozone concentration of from 0.5  $\mu\text{g}/\text{ml}$  to about 100  $\mu\text{g}/\text{ml}$ .



US00608652A

**United States Patent** [19]  
**Bolton**

[11] **Patent Number:** **6,086,552**  
[45] **Date of Patent:** **\*Jul. 11, 2000**

- [54] **TREATMENT OF CHRONIC POST-TRAUMATIC PAIN SYNDROMES**
- [75] Inventor: **Anthony E. Bolton**, Tideswell, United Kingdom
- [73] Assignee: **Vasogen, Inc.**, Mississauga, Canada
- [\*] Notice: This patent is subject to a terminal disclaimer.
- [21] Appl. No.: **09/090,465**
- [22] Filed: **Jun. 4, 1998**
- [51] **Int. Cl.<sup>7</sup>** ..... **A61M 37/00; A61B 19/00**
- [52] **U.S. Cl.** ..... **604/4; 128/898**
- [58] **Field of Search** ..... **604/4; 422/44; 128/898; 210/758, 760**

93/15779 8/1993 WIPO .  
96/34613 11/1996 WIPO .  
98/07436 2/1998 WIPO .

**OTHER PUBLICATIONS**

Bolton, Treatment of severe Raynaud's syndrome by injection of autologous blood pretreated by heating, ozonation and exposure to ultraviolet light, *International Angiology*, 1997, vol. 16/4, pp. 250-264.  
Bolton, Effect of combined heat, ozonation and ultraviolet irradiation on heat shock protein expression by peripheral blood leukocyte populations, *J. Biol. Regul. Homeostatic Agents*, 1997, vol. 11/3, pp. 104-110.  
Baran et al, *Mueller Medical Int'l, Inc.*, Oakville, Ontario, Canada (1990).

*Primary Examiner*—Mark O. Polutta  
*Assistant Examiner*—Patricia M. Bianco  
*Attorney, Agent, or Firm*—Nixon & Vanderhye

- [56] **References Cited**
- U.S. PATENT DOCUMENTS**
- 4,968,483 11/1990 Muller et al .
- 5,591,457 1/1997 Bolton .
- 5,834,030 11/1998 Bolton ..... 424/613
- FOREIGN PATENT DOCUMENTS**
- 2191940 6/1996 Canada .
- 2206180 11/1998 Canada .
- 4446292 12/1994 Germany .
- 93/15778 8/1993 WIPO .

[57] **ABSTRACT**  
Reflex sympathetic dystrophy in a human patient is treated by collecting an aliquot of the patient's blood (e.g. 10 cc in volume), and subjecting it simultaneously to ozone/oxygen mixture and ultraviolet light, at a predetermined, elevated (e.g. 42.5° C.) temperature, for approximately 3 minutes. After cooling, the treated blood aliquot is reinjected into the patient via the gluteal muscle. Reflex sympathetic dystrophy is alleviated following a course of such treatments.

**7 Claims, No Drawings**

## TREATMENT OF CHRONIC POST-TRAUMATIC PAIN SYNDROMES

### FIELD OF THE INVENTION

This invention relates to methods of medical treatment, and more specifically to the treatment of reflex sympathetic dystrophy.

### BACKGROUND OF THE INVENTION

Reflex sympathetic dystrophy (RSD) is a pathogenic condition affecting a patient's extremities and characterized by persistent pain and swelling with vasomotor and sudomotor changes, and later atrophy. The precipitating cause of RSD is soft tissue injury. Fractures of the bones of the wrists are commonly associated with RSD. Chronic undiagnosed knee pain, with few clinical signs beyond hyperaesthesia and limited movement may suggest RSD. It may only manifest itself days, weeks, or even years after the soft tissue injury has been incurred.

Adopting clinical criteria, the following operational definition of RSD was adopted at the Sixth World congress of Pain:

"RSD is a descriptive term meaning a complex disorder or group of disorders that may develop as a consequence of trauma affecting the limbs, with or without an obvious nerve lesion. RSD may also develop after visceral diseases, and central nervous system lesions or, rarely, without an obvious antecedent event. It consists of pain and related sensory abnormalities in the motor system and changes in structure of both superficial and deep tissues ("trophic changes"). It is not necessary that all components are present. It is agreed that the name "reflex sympathetic dystrophy" is used in a descriptive sense and does not imply specific underlying mechanisms".

The pathogenesis and pathophysiology of reflex sympathetic dystrophy are most commonly characterized by impaired vasomotor control which usually results in vasodilation and increased skin temperature over the affected area, in the initial stages, and vasoconstriction and reduced skin temperature in the later stages. Also, the blood flow and skin temperature changes in the contralateral limb following cold stress of the affected limb are abnormal, thus suggesting a central nervous system abnormality.

There is currently no specific, accepted treatment for RSD, and cure of it cannot be assured. Vascular and perhaps neurological changes occur during the natural history of the disease. Some treatments are directed to those. For example, calcitonin, a vasoconstrictor, is often used during the early vasodilation stage, but is inappropriate at later stages when vasoconstriction predominates. In this stage, pharmacologic or surgical sympathectomy is effective in some cases. Immobilization of the affected limb is avoided, since this exacerbates the problem. Alternative therapies include corticosteroids, transcutaneous nerve stimulation, acupuncture and autogenic training.

### REFERENCE TO THE PRIOR ART

A review of reflex sympathetic dystrophy by Dr. E. D. Cooke, Thermographic and Blood Flow Unit, St. Bartholomew's Hospital, London, U.K., appears in "Vascular Medicine Review", 1994; 5: 319-330.

### SUMMARY OF THE INVENTION

It is an object of the present invention to provide a novel treatment for reflex sympathetic dystrophy.

According to the present invention, the treatment for alleviating reflex sympathetic dystrophy, RSD, involves extracting an aliquot of blood of a patient suffering from RSD and treating it (either as whole blood or the appropriate fraction thereof) with certain stressors, namely UV radiation, heat and an oxidative environment. The aliquot so treated is reinjected intramuscularly into the patient. Following one or more such treatments, spaced at appropriate intervals, alleviation of the RSD is experienced.

Another aspect of the present invention is an autologous blood aliquot for administration to a patient to alleviate RSD, the aliquot having a volume of from about 0.01 ml to about 400 ml, and being characterized by the presence therein, in comparison with normal blood of the patient from whom it was extracted, of at least one of the following characterizing features:

- increased numbers of lymphocytes and other leucocytes, exhibiting a condensed apoptotic-like morphology;
- a release of specific proteins from the cell surface of the blood leucocytes, including the MHC Class II molecule HLA-DR, resulting in a reduction in the number of cells expressing such surface proteins;
- an upregulation in the expression of certain cell surface markers for example CD-11b, a component of the ligand for the cell adhesion molecule ICAM-1;
- a decrease in the amount of heat shock protein HSP-60 contained in the leucocytes, particularly the lymphocytes, therein, and an increase in HSP-60 in the plasma;
- a decrease in HSP-72 within the lymphocytes;
- a decrease in proliferation of treated mononuclear cells following mitogenic stimulation.

### DESCRIPTION OF THE PREFERRED EMBODIMENTS

By inducing an apoptotic-like state in the lymphocytes and other leucocytes in the blood comprising the aliquot, as evidenced by the increased numbers of lymphocytes and other leucocytes exhibiting a condensed apoptotic-like morphology therein, these cells may become preferentially phagocytosed upon re-injection into the host body.

There are a number of different phagocytic cell types present in the mammalian body, including various antigen presenting cells and neutrophils. In order to facilitate phagocytosis by antigen presenting cells rather than by other phagocytes, the lymphocytes and other leucocytes present in the aliquot of the invention are treated so that they may interact preferentially with antigen presenting phagocytic cells. Cells adhere to each other by a number of mechanisms including the expression of cell adhesion molecules. Cell adhesion molecules present on one cell type interact with specific ligands for particular adhesion molecules present on the adhering cell type. The present invention may result in a preferential interaction of cells in the treated aliquot to antigen presenting cells in the host body, by upregulation, on the surface of the cells in the treated aliquot of the expression of the ligand for adhesion molecules found on antigen-presenting cells in the host body. Antigen presenting cells express a number of cell adhesion molecules, including ICAM-1, a component of the ligand of which is CD-11b. One way by which the process of the invention may change the preferential phagocytosis of apoptosing cells is by upregulation of CD-11b.

The preparation of the blood aliquot for use according to the present invention preferably comprises extracting from

the patient an aliquot of blood of volume about 0.01 ml to about 400 ml, and contacting the aliquot of blood, extracorporeally, with an effective amount of ozone gas and ultraviolet radiation.

The treatment for the alleviation of reflex sympathetic dystrophy, RSD, in a human patient suffering therefrom, in accordance with preferred embodiments of the present invention, comprises extracting from the patient an aliquot of blood of volume about 0.01 ml to about 400 ml, contacting the aliquot of blood, extracorporeally, with an effective amount of ozone gas, heat and ultraviolet radiation, followed by administering the treated blood aliquot to the human patient.

In the preferred blood aliquot used in the present invention, the number of mononuclear cells or leucocytes exhibiting the presence of RSP-60 therein is decreased, as is the amount of HSP-60 in each cell, as compared with the normal, untreated peripheral blood of the source patient. Whereas the patient normally has, typically, about 30% of mononuclear cells exhibiting the presence of HSP-60 therein (as measured by whole blood intracellular flow cytometry), the treated aliquot has only 12–20%. In clinical studies, it has been found that the figure reduces from 29.3% to 15.5%, mean of six tests. Preferably also, the number of leucocytes exhibiting the presence of HSP-72, which is about 50% in the untreated blood of the source patient, is reduced to 25–35% in the treated aliquot of the present invention. In clinical studies, this figure for HSP-72 reduced from 49.4% in untreated blood to 30.2% in the treated aliquot, mean of six tests, similarly measured.

The number of cells which express the cell surface specific protein HLA-DR, in the preferred aliquot used in the present invention, is reduced as compared with the patient's untreated blood, possibly as a result of its release from the cell surface. Typically, the number of cells expressing HLA-DR reduces from about 23% to about 8–12%, as measured by whole blood flow cytometry. In clinical studies, this figure reduced from 23.3% to 10.3%, mean of five experiments.

The upregulation of the surface marker CD-11b in the preferred aliquot used in the present invention can be expressed as an increase in the percentage of neutrophils in the aliquot which test positive for CD-11b, compared with the patient's source blood. Typically, the increase is from about 10% up to the approximate range 70–95%. In clinical studies, an increase from 10.3% to 84% was obtained, mean of six tests.

A significant feature of the present invention is that the source of the blood from which the aliquot is prepared for a specific patient is the patient himself or herself. The antigens forming the basis of the aliquot find their origin in the patient's own blood. No extraneous antigens are added; the effective antigens are present in the patient's blood, and/or are released or modified by the process of preparing the aliquot using the patient's own blood as the source material.

The treated aliquot is prepared by extracting the patient's venous blood into an anticoagulant such as sodium citrate (a standard, routine procedure), and then exposing the extracted blood aliquot to at least one stressor, in controlled amounts, the stressor being selected from among oxidizing agents such as ozone, ultraviolet radiation and elevated temperature, and combinations of two or more of such stressors. The resulting blood aliquot, after such treatment, can be reinjected into the patient. Following a course of such treatments, a patient's RSD may be markedly improved.

Preferably, the stressors to which the leucocytes in the extracted blood aliquot are subjected are a temperature stress

(blood temperature above body temperature), an oxidative environment, such as a mixture of ozone and oxygen bubbled through the blood aliquot, and ultraviolet radiation, simultaneously or successively, but preferably simultaneously.

The preferred embodiments of the present invention provide a method of alleviating reflex sympathetic dystrophy in a human patient, which comprises:

- (a) contacting of about 0.01 ml to about 400 ml of the human patient's blood with an effective amount of ozone gas and ultraviolet radiation; and
- (b) administering the blood treated in step (a) to the human patient.

In general, from about 0.01 ml to about 400 ml of blood may be treated according to the invention. Preferred amounts are in the range of about 0.1 ml to 200 ml. More suitably, the aliquot for treatment has a volume of from about 0.1–100 mls, preferably 1–50 ml and most preferably 5–15 mls. The method most preferably involves collecting 10 ml of a patient's venous blood into sodium citrate coagulant, transferring it to a sterile, disposable low-density polyethylene vessel, and then treating it with ozone gas and ultraviolet radiation, then re-administering the treated blood to the patient by intramuscular injection.

As noted, it is preferred, according to the invention, to apply all three of the aforementioned stressors simultaneously to the aliquot under treatment. Care must be taken not to utilize an excessive level of the stressors, to the extent that the cell membranes of the white cells are caused to be disrupted.

The temperature stressor must keep the aliquot in the liquid phase, i.e. from about 0° C. to about 56° C. and should not heat it above about 55° C. Any suitable source of heat known in the art may be employed to heat the blood, preferably one or more infrared lamps. Preferably the temperature stressor warms the aliquot being treated, to a temperature above normal body temperature, i.e. to about 37–45° C, and most preferably from about 37–43° C., e.g. about 42.5° C. Preferably the temperature of the blood aliquot is maintained at this elevated temperature during the treatment with UV/ozone.

Alternatively, the blood sample is heated while being subjected to UV radiation, until the blood reaches a predetermined temperature (preferably about 42.5° C.), at which point bubbling of ozone gas through the blood is commenced. The concurrent UV/ozone treatment is then maintained for a predetermined period of time, preferably about 3 minutes.

Another alternative method involves subjecting the blood to UV/ozone while heating to a predetermined temperature (preferably about 42.5° C.), then either ending the treatment once the predetermined temperature is reached, or continuing UV/ozone treatment for a further period of time, most preferably about 3 minutes.

The application of the oxidative stressor preferably involves exposing the aliquot to a mixture of medical grade oxygen and ozone gas, most preferably by bubbling through the aliquot, at the aforementioned temperature range, a stream of medical grade oxygen gas having ozone as a minor component therein. The ozone gas may be provided by any conventional source known in the art. Suitably the gas stream has an ozone content of from about 1.0–100 µg/ml, preferably 3–70 µg/ml, and most preferably from about 5–50 µg/ml. The gas stream is supplied to the aliquot at a rate of from about 0.01–2.0 liters per minute, preferably 0.1–1.0 liters per minute and most preferably at about 0.12 liters per minute (STP).

The ultraviolet radiation stressor is suitably applied by irradiating the aliquot under treatment from an appropriate source of UV radiation, while the aliquot is maintained at the aforementioned temperature and while the oxygen/ozone gaseous mixture is being bubbled through the aliquot. The ultraviolet radiation may be provided by any conventional source known in the art, for example by a plurality of low-pressure ultraviolet lamps. The method of the invention preferably utilizes a standard UV-C source of ultraviolet radiation, namely UV lamps emitting in the C-band wavelengths, i.e. at wavelengths shorter than about 280 nm. Ultraviolet radiation corresponding to standard UV-A and UV-B sources can also be used. Preferably employed are low-pressure ultraviolet lamps that generate a line spectrum wherein at least 90% of the radiation has a wavelength of about 253.7 nm. An appropriate dosage of such UV radiation, applied simultaneously with the aforementioned temperature and oxidative environment stressors, is obtained from lamps with a power output of from about 5 to about 25 watts, preferably about 5–10 watts, at the chosen UV wavelength, arranged to surround the sample container holding the aliquot. Each such lamp provides an intensity, at a distance of 1 meter, of from about 40–80 microwatts per square centimeter. Several such lamps surrounding the sample bottle, with a combined output at 253.7 nm of 15–40 watts, preferably 20–40 watts operated at maximum intensity, may advantageously be used. At the incident surface of the blood, the UV energy supplied may be from about 0.25–4.5 Joules per cm<sup>2</sup> during a 3-minute exposure, preferably 0.9–1.8 J/cm<sup>2</sup>. Such a treatment provides a blood aliquot which is appropriately modified according to the invention to create the treated aliquot outlined above ready for re-injection into the patient.

The time for which the aliquot is subjected to the stressors can be from a few seconds to about 60 minutes. It is normally within the time range of from about 0.5–60 minutes. This depends to some extent upon the chosen intensity of the UV irradiation, the temperature and the concentration of and rate at which the oxidizing agent is supplied to the aliquot. The more severe the stressors applied to the aliquot, generally the shorter time for which they need to be applied. Some experimentation to establish optimum times may be necessary on the part of the operator, once the other stressor levels have been set. Under most stressor conditions, preferred times will be in the approximate range of about 0.5–10 minutes, most preferably 2–5 minutes, and normally around 3 minutes. The starting blood temperature, and the rate at which it can be warmed or cooled to a predetermined temperature, tends to vary from patient to patient.

In the practice of the preferred process of the present invention, the blood aliquot (or the separated cellular fractions of the blood, or mixtures of the separated cells, including platelets, these various leucocyte-containing combinations, along with whole blood, being referred to collectively throughout as the "aliquot") may be treated with the stressors using an apparatus of the type described in U.S. Pat. No. 4,968,483 Mueller. The aliquot is placed in a suitable, sterile, UV-radiation-transmissive container, which is then fitted into the machine. The temperature of the aliquot is adjusted to the predetermined value, e.g. 42.5° C., by the use of a suitable heat source such as an IR lamp, and the UV lamps are switched on for a fixed period before the gas flow is applied to the aliquot providing the oxidative stress, to allow the output of the UV lamps to stabilize. Then the oxygen/ozone gas mixture, of known composition and controlled flow rate, is applied to the aliquot, for the predetermined duration of 0.5–60 minutes, preferably 2–5 minutes

and most preferably about 3 minutes as discussed above, so that the aliquot experiences all three stressors simultaneously. In this way, the blood aliquot is appropriately modified to produce a treated aliquot according to the present invention sufficient to achieve the desired treatment of reflex sympathetic dystrophy.

The invention is further described in the following working example.

#### EXAMPLE

A young (32 year old) adult female suffering from reflex sympathetic dystrophy was treated according to the process of the invention.

The patient's RSD manifested itself as extremely cold feet, with numerous small wounds (chilblains) on the feet. Even during hot summer weather, the patient experienced problems with foot pains. The patient was given a course of treatment according to the invention. At each treatment, a 10 ml aliquot of blood was withdrawn from the patient, and the blood aliquot was subjected to simultaneous treatment with an ozone/oxygen gaseous mixture (15±0.6 µg/ml of ozone) and ultraviolet light, for 3 minutes, at 42.5° C., in an apparatus as described in U.S. Pat. No. 4,968,483 Mueller. An IR lamp was used to heat the sterile container holding the blood aliquot to the preselected temperature. Ultraviolet radiation was supplied from a plurality of UV emitting lamps surrounding the container, the lamps providing a combined output at 253.7 nm wavelength of 0.26 Joules per cm<sup>2</sup> at the incident surface of the blood. After the treated aliquot had reverted to body temperature, it was re-injected intramuscularly into the patient, via the gluteal muscle.

The patient received initially a course of nine such treatments, three times weekly for three weeks. She reported improvement by the end of this initial course. After a three week interval, the patient reported that the improvement was lessening, and so she was given a further course of nine treatments over three weeks. The improvement resumed. After a 1–2 week break, after which signs of lessening of the improvement were reported by the patient, treatments were resumed on a twice per week basis for 6 weeks, followed by one per week for 4 weeks.

The patient reported a substantial alleviation, almost complete cure, of her RSD symptoms following the completion of these courses of treatments.

What is claimed is:

1. A process of alleviating the symptoms of reflex sympathetic dystrophy in a human patient suffering therefrom, which comprises:

extracting an aliquot of blood of volume from about 0.1 to 400 ml from the human patient;

treating the extracted aliquot extracorporeally with at least one stressor selected from a group of an oxidative environment, UV radiation and elevated temperature up to about 45° C. for a period of time in the range 0.5–60 minutes;

and reinjecting the aliquot so treated into the human patient.

2. The process of claim 1 wherein the aliquot of blood is subjected to all three said stressors simultaneously.

3. The process of claim 2 wherein the oxidative environment stressor is a mixture of medical grade oxygen and ozone, wherein the ozone content is from 0.1 to 100 µg/ml, bubbled through the blood aliquot.

4. The process of claim 2 wherein the ultraviolet radiation stressor is ultraviolet radiation from UV lamps emitting primarily at wavelengths of 280 nm or shorter.

7

5. The process of claim 2 wherein the elevated temperature stressor is a temperature in the range from 38–43° C.

6. A process of alleviating the symptoms of reflex sympathetic dystrophy in a human patient suffering therefrom, which comprises:

extracting an aliquot of blood of volume from about 0.1 to 400 ml from the human patient;

treating the extracted aliquot extracorporeally simultaneously with an oxidative environment consisting essentially of a mixture of medical grade oxygen and ozone, wherein the ozone content is from 0.1 to 100  $\mu\text{g}/\text{ml}$ , bubbled through the blood aliquot;

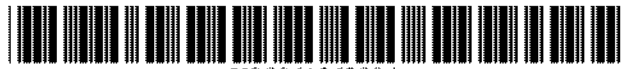
8

ultraviolet radiation from UV lamps emitting primarily at wavelengths of 280 nm or shorter;

and an elevated temperature in the range from about 38–43° C.; for a period of time in the range of 0.5–60 minutes; and reinjecting the aliquot so treated into the human patient.

7. A process of alleviating the symptoms of reflex sympathetic dystrophy in a human patient suffering therefrom, which comprises subjecting the patient to a course of from 18 to 34 treatments as defined in claim 6, over a period of 6–21 weeks.

\* \* \* \* \*



US006136308A

**United States Patent** [19]

[11] **Patent Number:** **6,136,308**

**Tremblay et al.**

[45] **Date of Patent:** **Oct. 24, 2000**

[54] **TREATMENT OF STRESS AND PRECONDITIONING AGAINST STRESS**

[75] Inventors: **Johanne Tremblay; Pavel Hamet**, both of Montreal, Canada

[73] Assignees: **Vasogen Ireland Limited**, Shannon, Ireland; **Centre de Recherche du Centre Hospitalier de l'Universite de Montreal (CHUM)**, Montreal, Canada

[21] Appl. No.: **09/151,653**

[22] Filed: **Sep. 11, 1998**

**Related U.S. Application Data**

[60] Provisional application No. 60/058,782, Sep. 12, 1997, and provisional application No. 60/059,172, Sep. 17, 1997.

[51] **Int. Cl.<sup>7</sup>** ..... **C12N 5/06**

[52] **U.S. Cl.** ..... **424/93.7; 435/2; 435/366; 435/372**

[58] **Field of Search** ..... **424/93.7; 435/2, 435/366, 372**

[56] **References Cited**

**U.S. PATENT DOCUMENTS**

4,968,483	11/1990	Muller et al.	422/45
5,591,457	1/1997	Bolton	424/613
5,891,653	4/1999	Attfield	435/7.21
5,906,636	5/1999	Casscells, III et al.	607/96

**OTHER PUBLICATIONS**

Perdrizet, G. A. et al., "Heat Shock and Recovery Protects Renal Allografts from Warm Ischemic Injury and Enhances HSP72 Production," *Transplantation Proceedings* vol. 25, No. 1: pp. 1670-1673, Feb. 1993.

Nishina, H. et al., "Stress-signalling kinase SEK 1 Protects Thymocytes from Apoptosis Mediated by CD 95 and CD 3," *Nature*, vol. 385, No. 1614, Jan. 1997.

*Primary Examiner*—Jean C. Witz  
*Attorney, Agent, or Firm*—Nixon & Vanderhye

[57] **ABSTRACT**

Symptoms of stress such as elevated blood pressure in mammals are treated, and mammalian bodies are preconditioned to manifest reduced adverse reactions to subsequently encountered stresses, by injecting into the mammalian patient a small quantity of the patient's own blood which has been previously extracted and subjected extracorporeally to at least one stressor, such as ultraviolet radiation, an oxidative environment, ozone-oxygen and mild heating, especially infra-red radiation causing mild heating. Particularly beneficial combinations of stressors are simultaneous applications of UV radiation and an ozone-oxygen gas mixture bubbled through the blood sample to provide the oxidative environment, or simultaneous application of UV radiation, ozone-oxygen gas mixtures and mild heating. One specific use of the invention is in preconditioning against ischemic-reperfusion injury, e.g. prior to surgery.

**41 Claims, 10 Drawing Sheets**



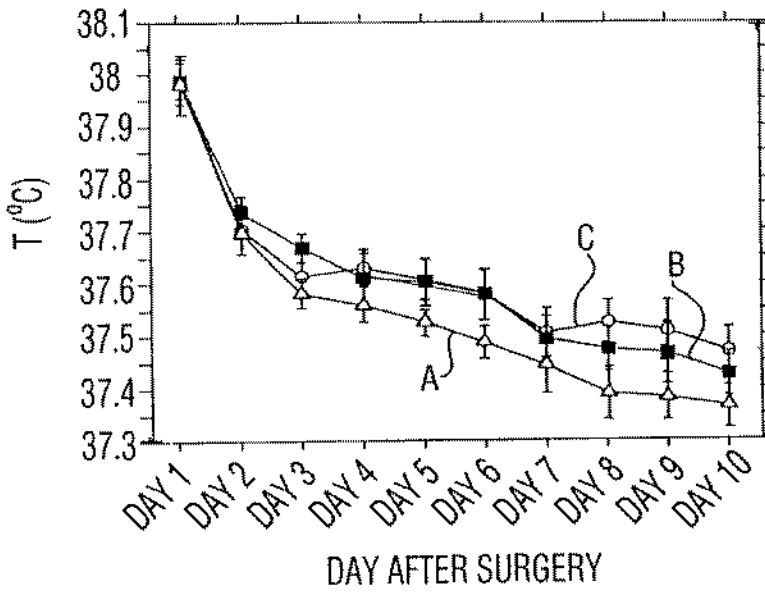


FIG. 1

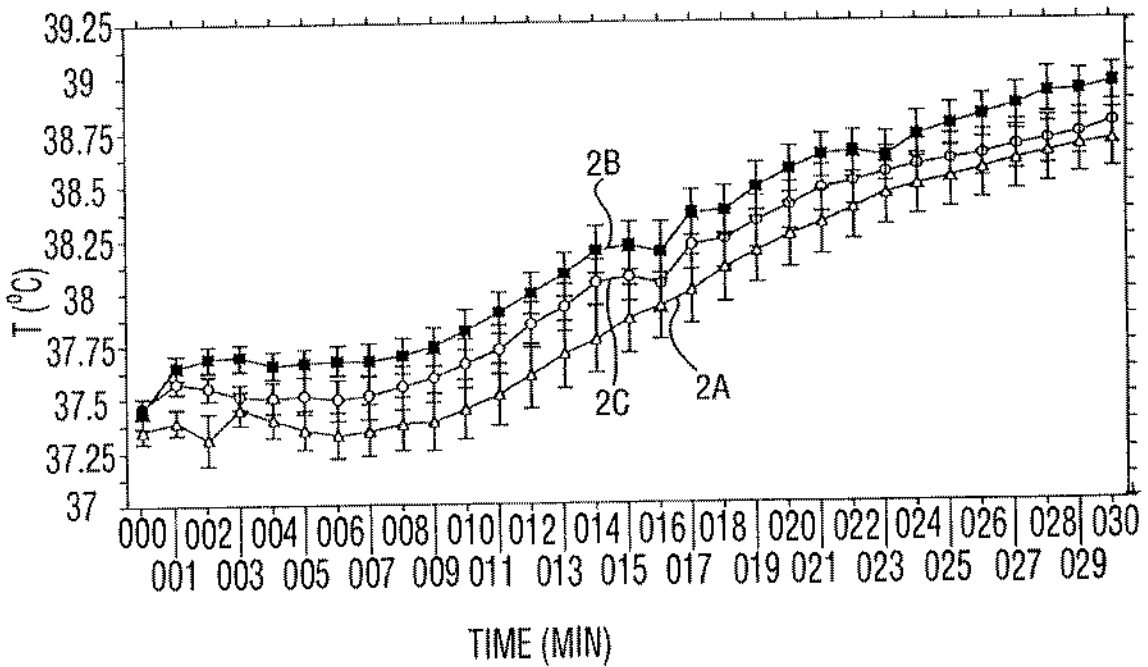


FIG. 2

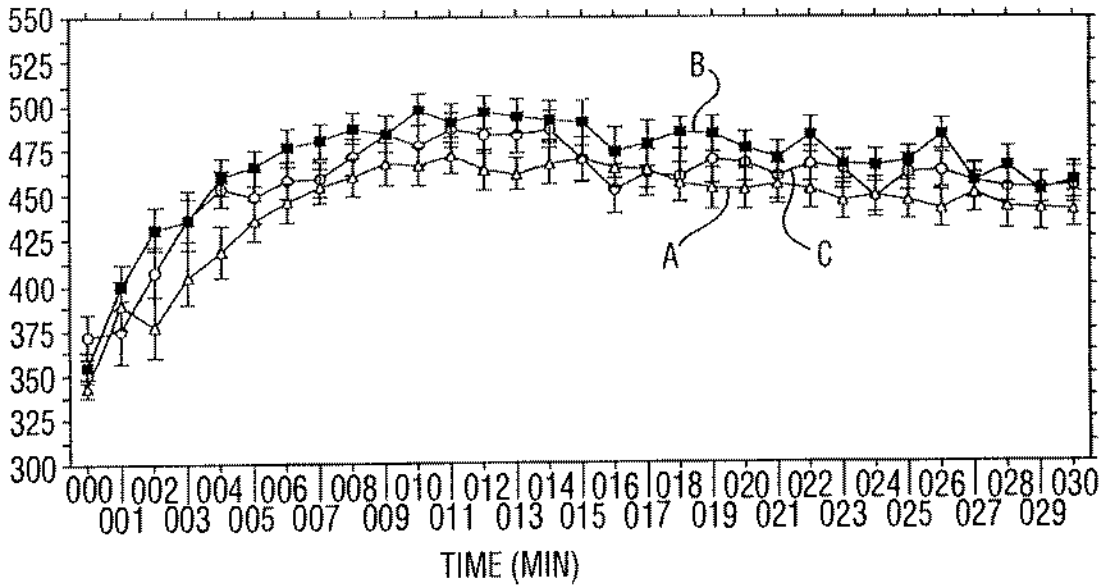


FIG. 3

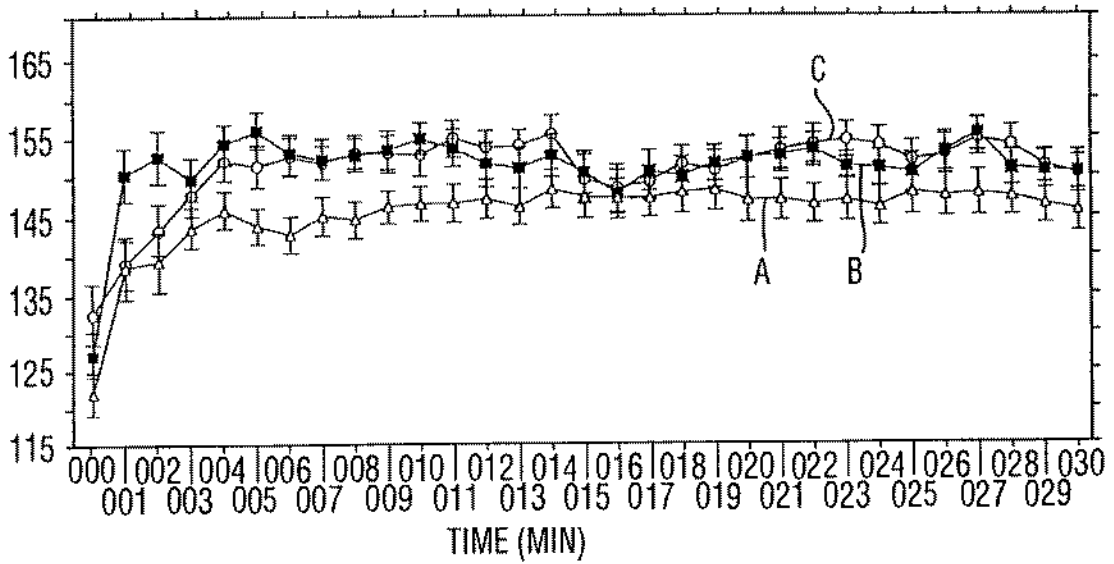


FIG. 4

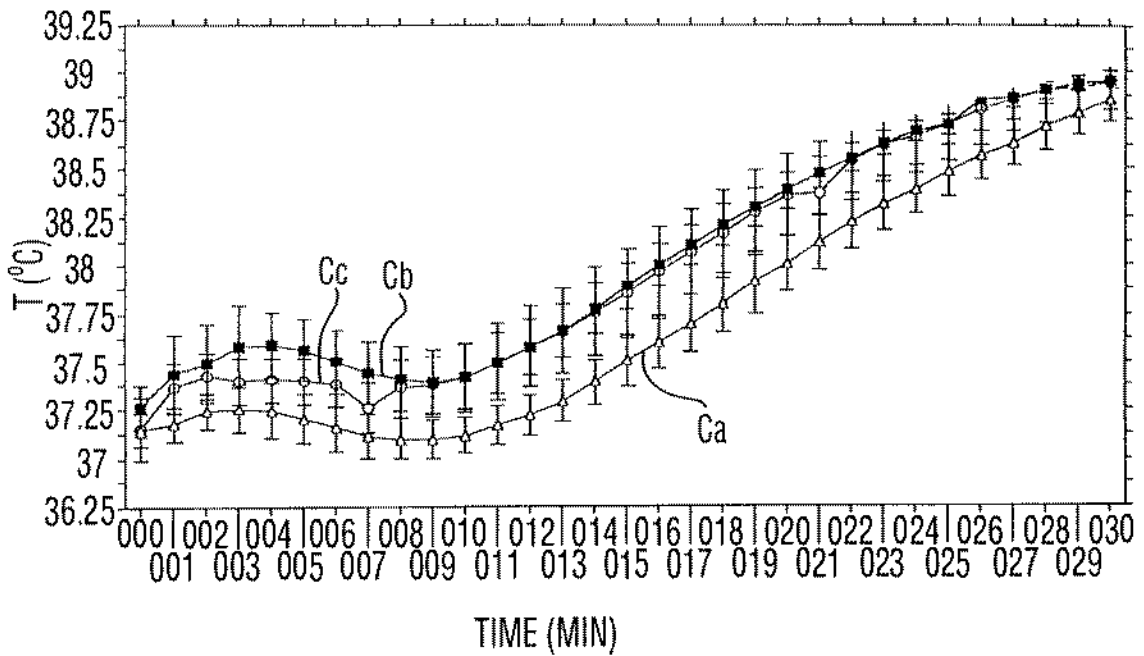


FIG. 5

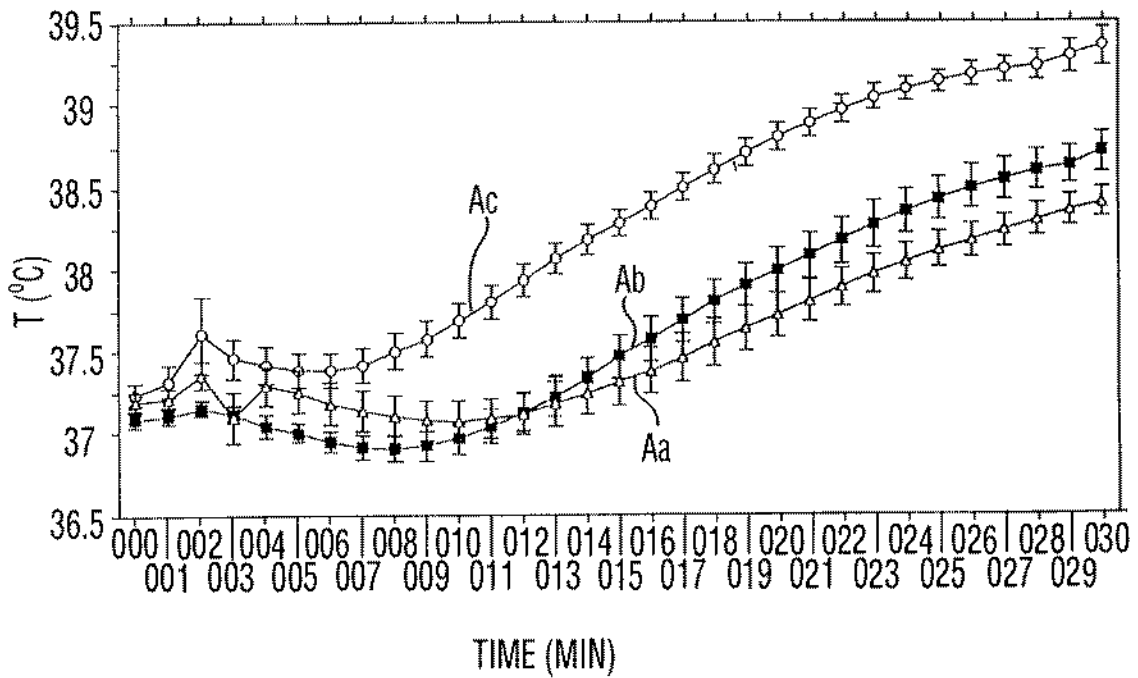


FIG. 6

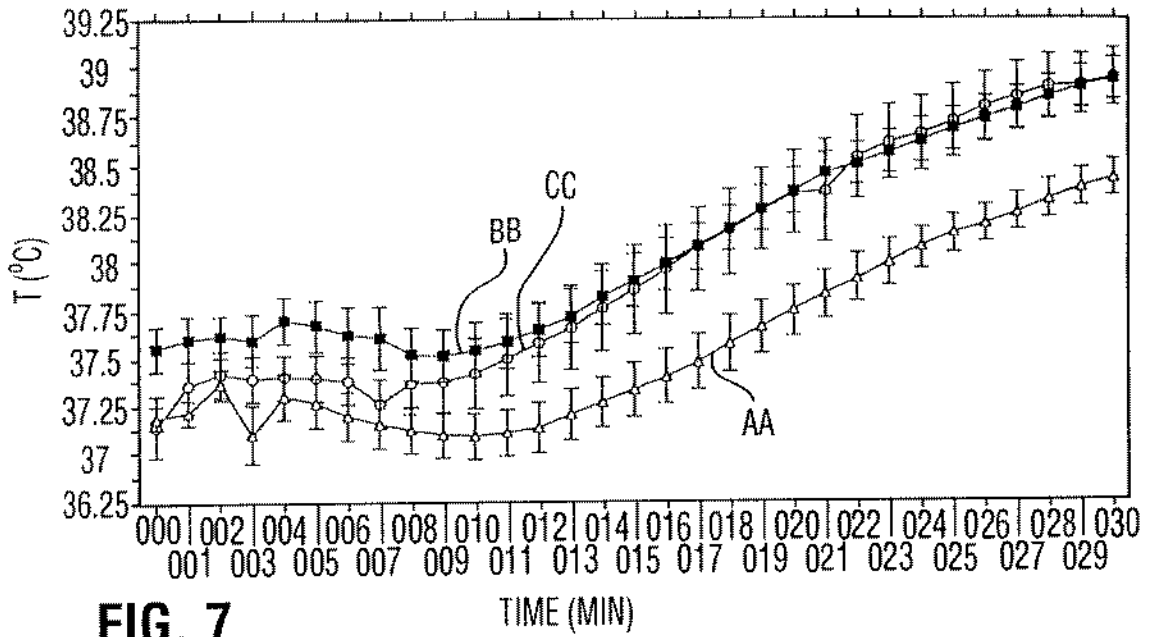


FIG. 7

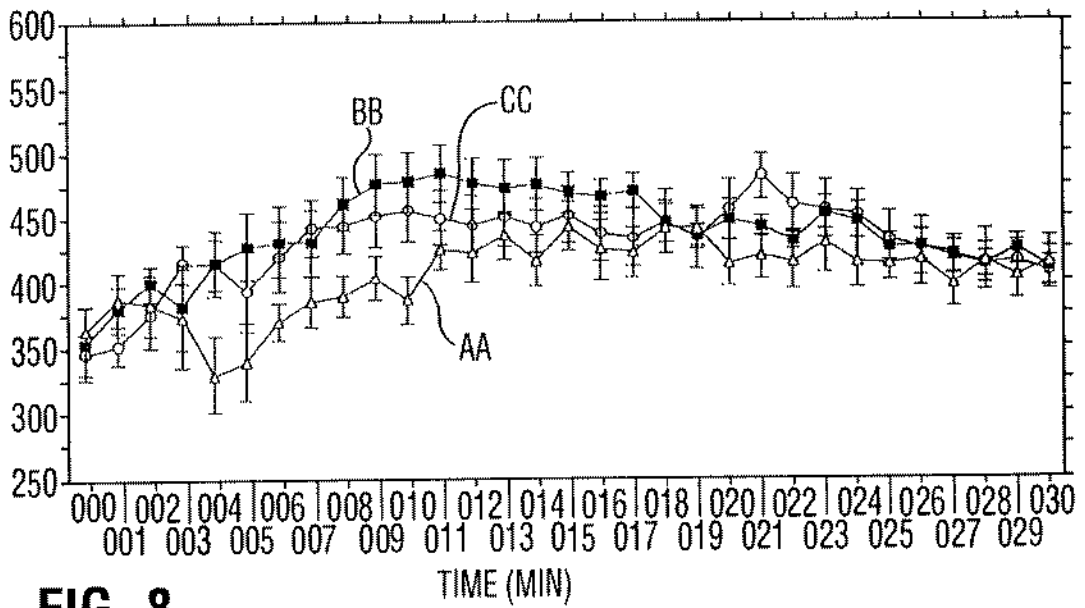
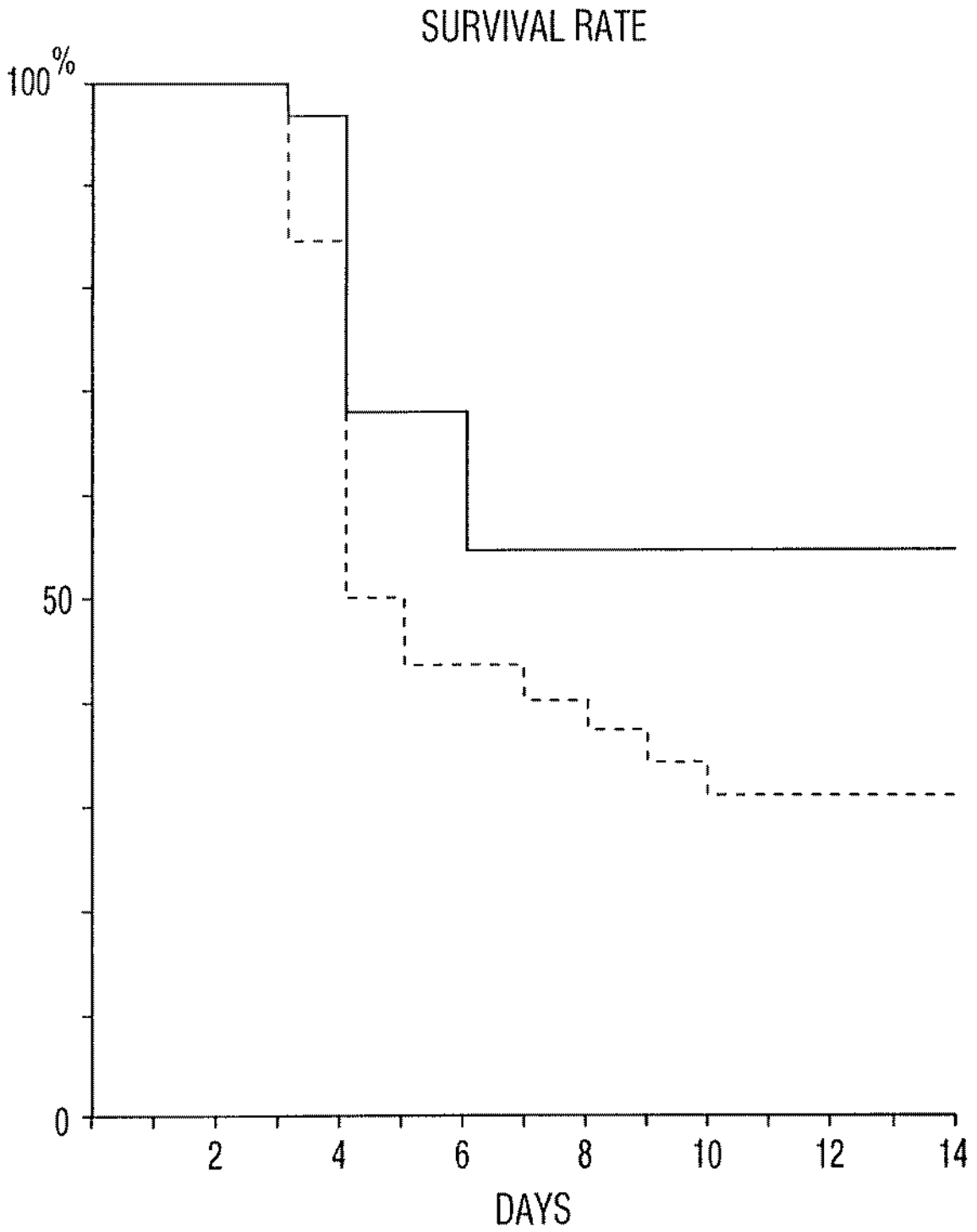
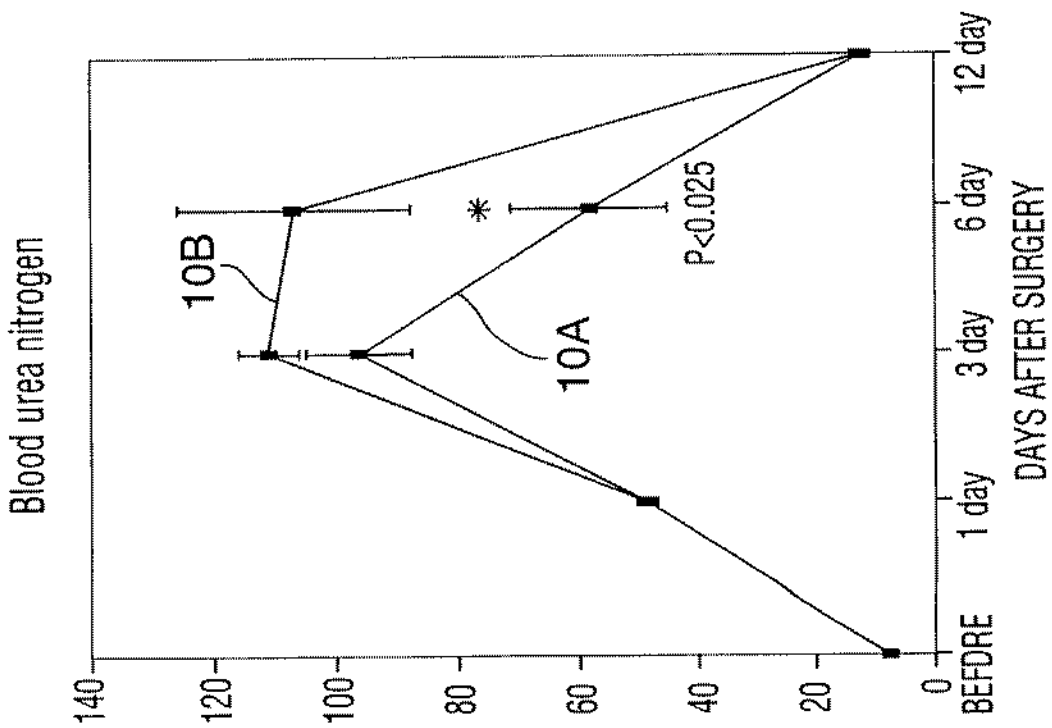
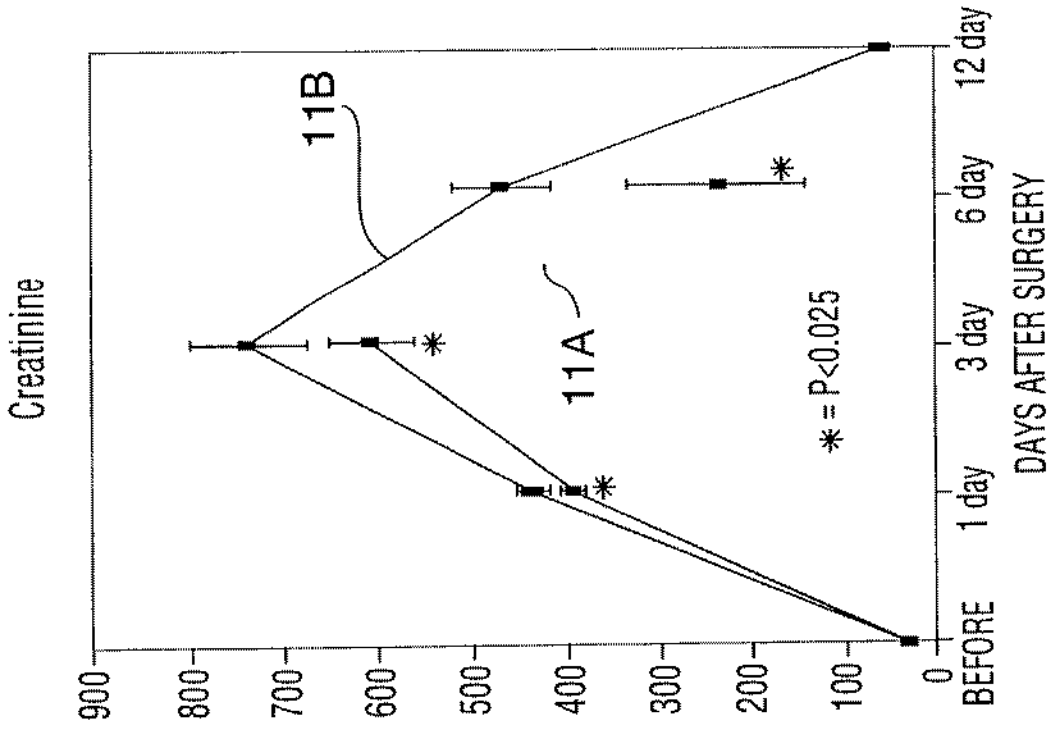
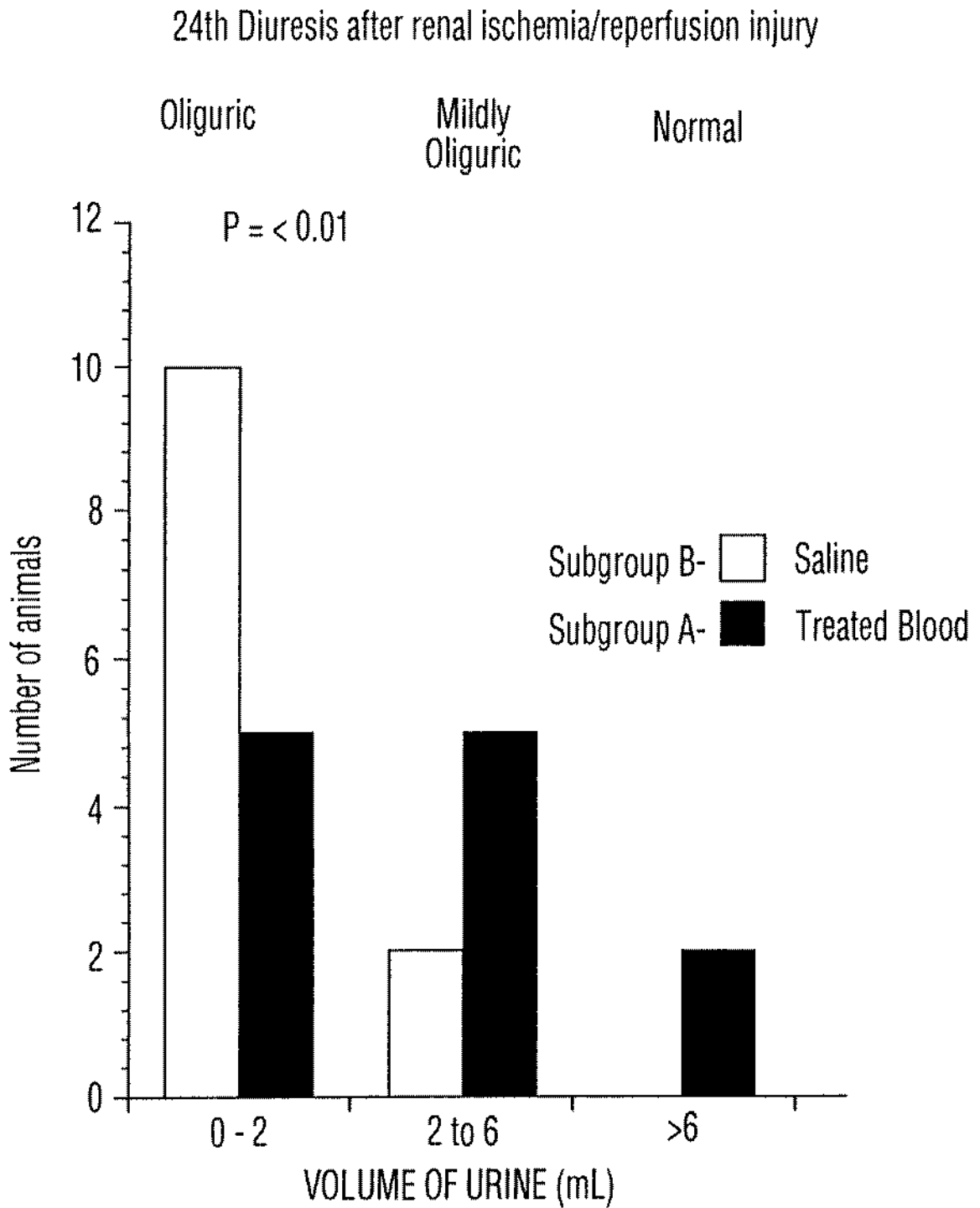


FIG. 8



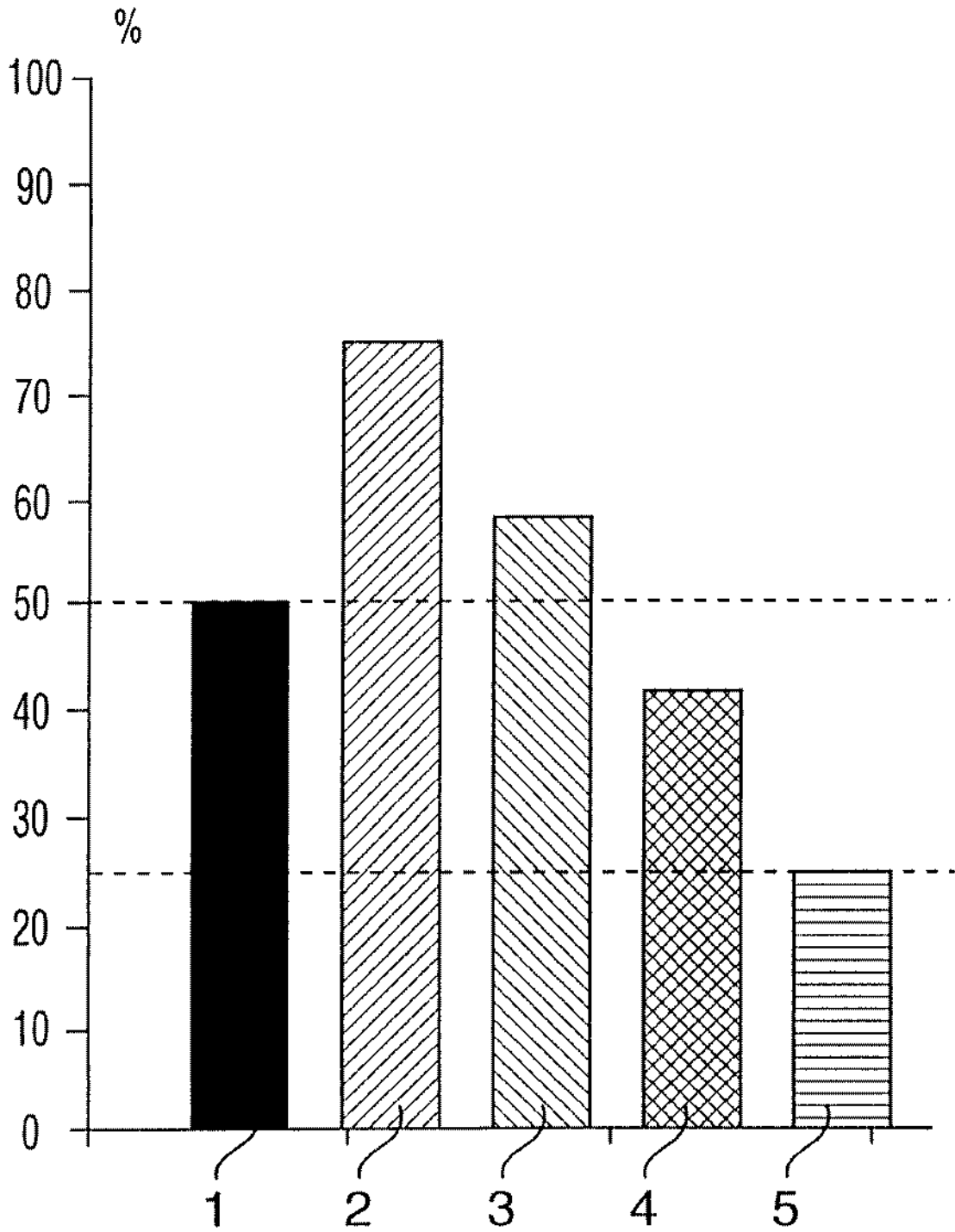
**FIG. 9**





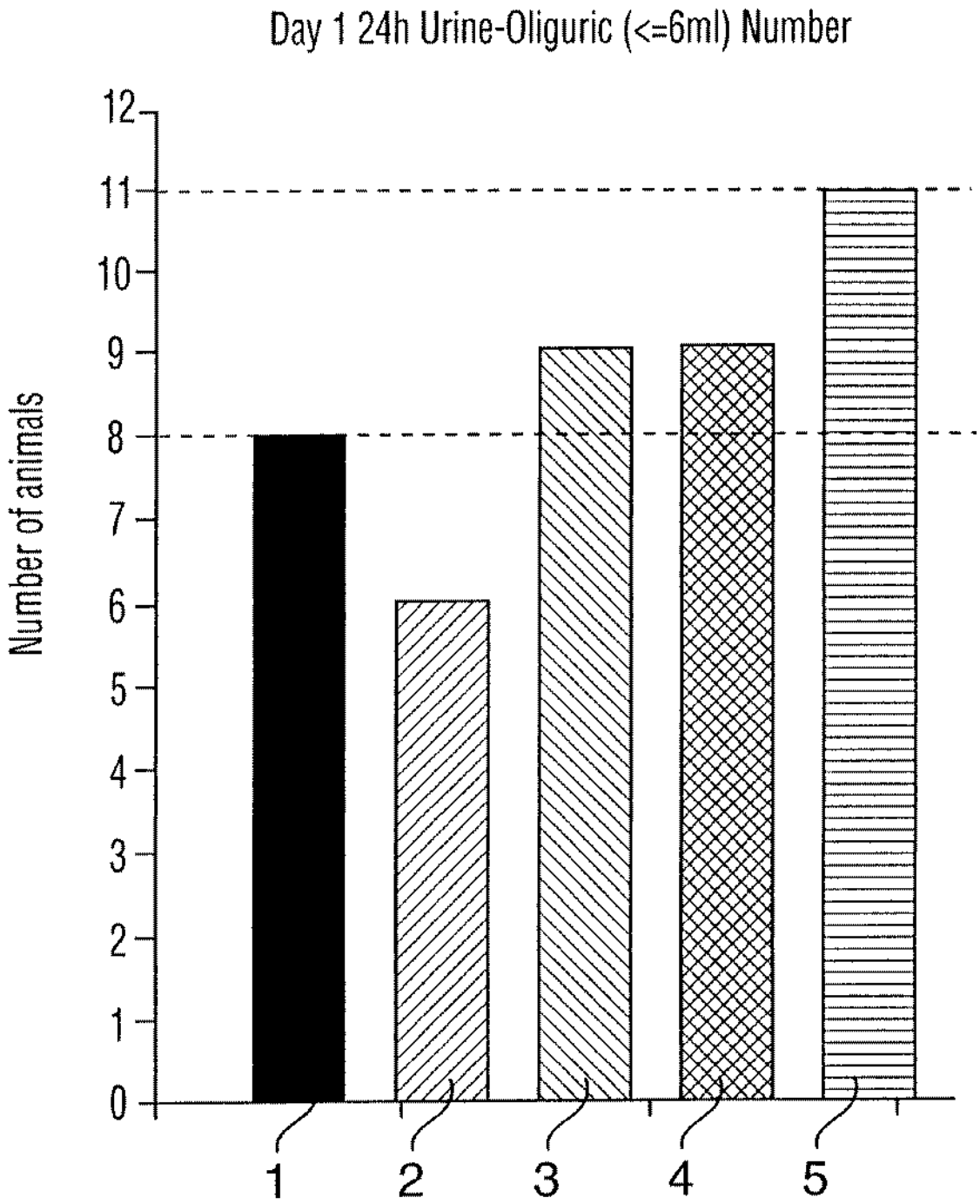
**FIG. 12**

### SURVIVAL RATE



**FIG.13**





**FIG. 14**

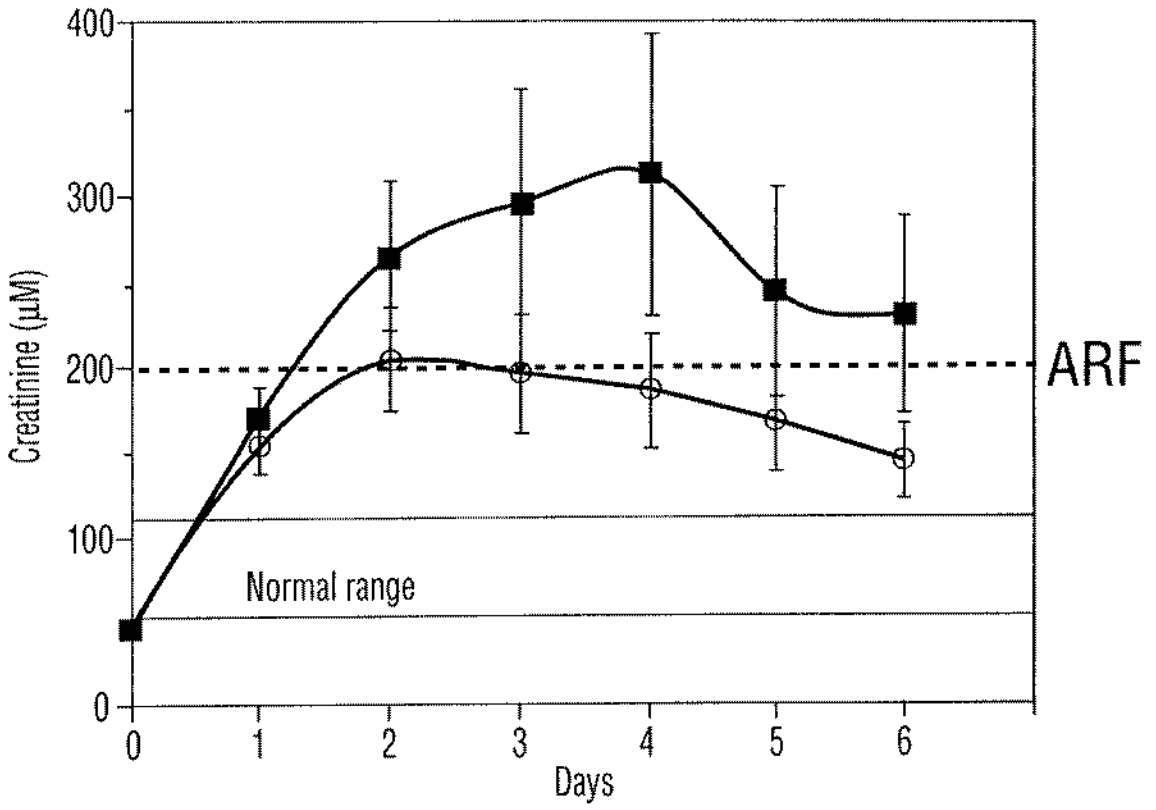


FIG. 15

## TREATMENT OF STRESS AND PRECONDITIONING AGAINST STRESS

This application claims the benefit of U.S. Provisional Applications Nos. 60/058,782 filed Sep. 12, 1997, and 60/059,172 filed Sep. 17, 1997.

### FIELD OF THE INVENTION

This invention relates to the field of medicine and medical treatments. In particular, it relates to stress treatment and more specifically to a method and composition for treating mammals, including humans, in order to provide them with improved reactions and resistance to stress.

### BACKGROUND AND PRIOR ART

The effects of stress on a mammal normally manifest themselves in an increase in body temperature, along with a change in hemodynamic parameters, including an increase in heart rate and an increase in blood pressure. For patients already suffering from elevated blood pressure (hypertension), the effects of stress can therefore be particularly dangerous, since hypertension is a major risk factor for cardiovascular disease.

Stresses to which a mammal may be subjected, and which can result in these effects, can take a wide variety of physical forms. Psychological stresses induced by restraint, confinement, sudden exposure to danger, shock and the like translate into physical stresses affecting one or more organs of the body. Similarly, physical stress such as exposure to heat or cold, injury including surgical injury, over-exertion and the like, result in abnormal functioning of body organs. Stress is now recognized as a major detrimental factor in many diseases such as cardiovascular disease, cancer, and immunological dysfunction. Common physiological events which appear to underlie all stress responses include the induction and upregulation of synthesis, in all body cells, of a group of specialized intracellular proteins known as heat stress proteins or heat shock proteins (HSP's). These HSPs function to protect the cells from potential damage caused by whatever form of stress is being applied.

One particular species of physical stress is ischemia, which is the deprivation of oxygen resulting from reduced blood flow. Ischemia in a body organ, if severe enough, causes the eventual death of cells in the organ. Reperfusion of the ischemic organ by resumption of blood flow thereto often results in further injury to the organ due to inflammation, and does not invigorate already injured cells. Repeated application of mild ischemic stress to an organ often leads to an increased ability to withstand stress ischemia, an effect thought to be partially related to upregulated synthesis of HSPs. Ischemia may occur as a pathological condition, e.g. as the result of spasm, thrombosis, or other blood vessel obstruction. Ischemia may be deliberately induced by clamping of blood vessels during surgery.

It is known to precondition the body of a mammalian patient by subjecting it to controlled stresses, so as better to equip the body for subsequent encounters with uncontrolled stresses of the same type. Physical exercise and training, for example, equips a body for better handling of physical exertion stresses. Heating a body or a body organ repeatedly under controlled conditions has been shown to provide the body or body organ with preconditioning for the better handling of subsequent heat stresses. Even in respect of ischemia, a body organ such as the heart which has previously suffered mild ischemia is better able to resist the effects of later ischemia, of the type causing myocardial

infarction. As stated by Gersh et al., "Preconditioning is an important phenomenon, probably with clinical implications, because repetitive anginal episodes in patients may develop into full fledged infarction. Patients with pre-infarction angina may suffer from a less severe infarct than those thought to undergo sudden coronary occlusion without the opportunity for preconditioning. In contrast, patients with multiple short-lived attacks of ischemia might become tolerant through the development of protective preconditioning, according to animal data."<sup>1</sup> Preconditioning by subjection to heat or ischemia is however clearly impractical in respect of most mammalian bodies and body organs.

U.S. Pat. No. 4,968,483 Mueller et al., describes an apparatus for oxygenating blood, by treating an aliquot of a patient's blood, extracorporeally, with an oxygen/ozone mixture and ultraviolet light, at a controlled temperature. The apparatus is proposed for use in hematological oxidation therapy.

U.S. Pat. No. 5,591,457 Bolton, discloses a method of inhibiting the aggregation of blood platelets in a human, a method of stimulating the immune system and a method of treating peripheral vascular diseases such as Raynaud's disease, by extracting an aliquot of blood from a patient, subjecting it to ozone/oxygen gas mixture and ultraviolet radiation at a temperature in the range of about 37-43° C., and then reinjecting the treated blood into the human patient.

International Patent Application PCT/GB93/00259 Bolton, describes a similar process for increasing the content of nitric oxide in the blood of a mammalian patient, potentially useful in treating conditions such as high blood pressure in mammalian patients.

### SUMMARY OF THE INVENTION

It is an object of the present invention to provide a novel method of treating stress in a mammalian patient.

It is a further object to provide a process of preconditioning a mammalian patient to improve the patient's resistance and reaction to subsequently encountered stress.

It is a further and important object of the invention to provide a means of protecting target organs against ischemia/reperfusion injury.

The present invention is based upon the discovery that an aliquot of a patient's blood, subjected extracorporeally to one or more stressors and then re-injected into the patient, has beneficial effects on the patient's subsequent abilities to withstand the adverse effects of subsequently encountered stresses, as well as beneficial effects on the symptoms of stress. According to the present information, application of selected stressors to the blood aliquot extracorporeally appears to cause changes in certain of the blood cells of the aliquot. It exerts beneficial effects [to] on the patient's blood including the increased resistance to subsequently encountered stresses as reported in more detail hereinafter.

Accordingly, from one aspect, the present invention provides a process of treating a mammalian patient to counteract the adverse effects of stress and/or to precondition the patient for improved resistance and reaction to subsequently encounter stress, which comprises extracting from the patient an aliquot of blood, subjecting the aliquot to extracorporeal application of one or more stressors thereto, and reinjecting the treated blood aliquot into the patient.

Stressors which can accordingly be used in the present invention, include oxidative stressors, heat stressors and ultraviolet radiation, alone or in combinations of two or

three of such stressors, and applied simultaneously or sequentially to the blood aliquot. Thus according to a more specific aspect of the present invention, there is provided a process of treating a mammalian patient to counteract the adverse effects of stress and/or to precondition the patient for improved resistance and reaction to subsequently encountered stress, which comprises extracting from the patient an aliquot of blood, subjecting the extracted blood aliquot extracorporeally to at least one stressor selected from an oxidative environment, UV radiation and elevated temperature, and reinjecting at least a portion of the treated blood aliquot into the patient.

### THE DRAWINGS

In the accompanying drawings:

FIG. 1 is a graphical representation of the results obtained according to specific Example 1 described below;

FIG. 2 is a graphical presentation of the body temperature results obtained according to Example 2 described below;

FIG. 3 is a graphical presentation of the heart rate results obtained according to Example 2 described below;

FIG. 4 is a graphical presentation of the diastolic blood pressure results obtained according to Example 2 described below;

FIG. 5 is a graphical presentation of the body temperature results obtained according to Example 3 described below;

FIG. 6 is a graphical presentation of the body temperature results obtained according to Example 4 described below;

FIG. 7 is a graphical presentation of the body temperature results obtained according to Example 5 described below;

FIG. 8 is a graphical presentation of the heart rate results obtained according to Example 5 described below;

FIGS. 9, 10, 11 and 12 are graphical presentations of results obtained according to Example 6 below;

FIGS. 13 and 14 are graphical presentation of results obtained according to Example 7 below; and

FIG. 15 is a graphical presentation of the results of Example 8.

### THE PREFERRED EMBODIMENTS

The method of the invention involves the extraction of an aliquot of blood from the patient, the subjection of the blood aliquot extracorporeally to one or more stressors and the re injection of the treated blood aliquot into the patient. The treatment counteracts the effects of stress from which the patient is suffering at the time and shortly after the patient receives the treatment. More significantly and importantly, as a result of the treatment, preferably a series of treatments, the patient is better equipped to withstand the adverse effects of subsequently encountered stress. The treatment process according to the present invention causes the mammalian patients, when subsequently stressed, to exhibit decreased stress responses as detected by smaller rises in body temperature, smaller increases in heart rate and/or smaller increases in diastolic blood pressure.

Thus, from another aspect, the present invention provides the use, for preparing a medicament for treating stress in a patient and for preconditioning a patient to better withstand the adverse effects of subsequently encountered stress, of an aliquot of blood which has been subjected extracorporeally to at least one stressor selected from an oxidative environment, UV radiation and elevated temperature.

The size of the blood aliquot to be treated is, in the case of human patients, generally from about 0.1 ml to about 400

ml, preferably from about 0.1–100 ml and most preferably 5–15 ml, with suitable prorating according to relative body weight for non-human patients. Care must be taken not to utilize an excessive level of the stressors, to the extent that the cell membranes of the white cells of the blood are caused to be disrupted, or other irreversible damage is caused to an excessive number of the cells in the blood.

In the preferred process of the present invention, the blood aliquot can be extracorporeally subjected to the heat stressor alone, to the UV stressor alone, or to the oxidative stressor alone. It can also be extracorporeally subjected to both the heat stressor and the UV stressor, to both the heat stressor and the oxidative stressor, and to both the UV stressor and the oxidative stressor. It can also be extracorporeally subjected to all three of the heat stressor, the oxidative stressor and the UV stressor. When combinations of two or more stressors are used, they can be applied sequential in any order, or simultaneously. Particularly beneficial results are obtained by simultaneous use of two of the three stressors, especially the oxidative stressor and the UV stressor, or the simultaneous use of all three of the stressors, as demonstrated in the specific examples which follow.

The temperature stressor must keep the aliquot in the liquid phase and should not heat it above about 45° C.

The term “elevated temperature” as used herein means a temperature higher than that which the blood attains at the start of the subjection of the blood to the stressors in the process of the invention. Depending upon the precise method of handling the blood aliquot, its temperature at the start of the process could be as low as 15° C. Whilst the blood aliquot is at body temperature (c. 37° C.) when first extracted from the patient, the act of extraction, the addition of anticoagulant, the introduction into the treatment apparatus and the storage of the blood aliquot may all exercise a cooling effect on the blood, to bring its temperature down to as low as 15° C. when the process starts. Accordingly the “elevated temperature stressor” applied in the process of the invention is a heating above this introductory temperature. Any suitable source of heat known in the art may be employed to heat the blood, preferably one or more infrared lamps. Thus, in a preferred process of the present invention, the blood aliquot is subjected to infra-red radiation as a stressor, alone or in combination with the other stressors namely UV radiation and an oxidative environment, the infrared radiation normally but not necessarily causing heating of the blood aliquot.

The temperature stressor preferably warms the aliquot being treated to a temperature above normal body temperature, i.e. to about 38–44° C., and most preferably from about 38–43° C., e.g. about 42.5° C., for a period of time from about ½ to about 10 minutes, and preferably about 1–5 minutes, most preferably about 3 minutes.

The application of the oxidative stressor preferably involves exposing the aliquot to a mixture of medical grade oxygen and ozone gas, most preferably by bubbling through the aliquot, at the aforementioned temperature range, a stream of medical grade oxygen gas having ozone as a minor component therein. The ozone gas may be provided by any conventional source known in the art. Suitably the gas stream has an ozone content of from about 1.0–100 µg/ml, preferably 3–70 µg/ml and most preferably from about 5–50 µg/ml. The gas stream is supplied to the aliquot at a rate of from about 0.01–2 liters per minute, preferably 0.05–1.0 liters per minute, and most preferably at about 0.06–0.30 liters per minute (STP). Alternative application of oxidative stressors include addition of peroxides such as hydrogen

peroxide to the blood, and addition of biochemically acceptable chemical oxidizing agents such as permanganates and periodates to the blood aliquot.

The ultraviolet radiation stressor is suitably applied by irradiating the aliquot under treatment from an appropriate source of UV radiation. The ultraviolet radiation may be provided by any conventional source known in the art, for example by a plurality of low-pressure ultraviolet lamps. The method of the invention preferably utilizes a standard UV-C source of ultraviolet radiation, namely UV lamps emitting primarily in the C-band wavelengths, i.e. at wavelengths shorter than about 280 nm. Ultraviolet radiation corresponding to standard UV-A and UV-B sources can also be used. Preferably employed are low-pressure ultraviolet lamps that generate a fine spectrum wherein at least 90% of the radiation has a wavelength of about 253.7 nm. An appropriate dosage of such UV radiation, applied simultaneously with the aforementioned temperature and oxidative environment stressors, is obtained from lamps with a power output of from about 5 to about 25 watts, preferably about 5 to about 10 watts, at the chosen UV wavelength, arranged to surround the sample container holding the aliquot. Each such lamp provides an intensity, at a distance of 1 meter, of from about 40–80 micro watts per square centimeter. Several such lamps surrounding the sample container, with a combined output at 253.7 nm of 15–40 watts, preferably 20–40 watts, operated at maximum intensity, may advantageously be used. At the incident surface of the blood, the UV energy supplied may be from about 0.25–4.5 J/cm<sup>2</sup> during a 3-minute exposure, preferably 0.9–1.8 J/cm<sup>2</sup>. Such a treatment provides a blood aliquot which is appropriately modified according to the invention ready for re-injection into the patient.

The time for which the aliquot is subjected to the stressor(s) can be from a few seconds to about 60 minutes. It is normally within the time range of from about 0.5–60 minutes. This depends to some extent upon the chosen intensity of the UV irradiation, the temperature and the concentration of and rate at which the oxidizing agent is supplied to the aliquot. Some experimentation to establish optimum times and dosages may be necessary on the part of the operator, once the other stressor levels have been set. Under most stressor conditions, preferred times will be in the approximate range of about 0.5–10 minutes, most preferably 2–5 minutes, and normally around 3 minutes. The starting blood temperature, and the rate at which it can be warmed or cooled to a predetermined temperature, tends to vary from patient to patient.

In the practice of the preferred process of the present invention, the blood aliquot (or the separated cellular fractions of the blood, or mixtures of the separated cells, including platelets, these various leucocyte-containing combinations, along with whole blood, being referred to collectively throughout as the "aliquot") may be treated with the stressors using an apparatus of the type described in U.S. Pat. No. 4,968,483 Mueller. The aliquot is placed in a suitable, sterile, UV-radiation-transmissive container, which is then fitted into the machine. The temperature of the aliquot is adjusted to the predetermined value, e.g. 42.5±1° C., by the use of a suitable heat source such as an IR lamp, and the UV lamps are switched on for a fixed period before the gas flow is applied to the aliquot providing the oxidative stress, to allow the output of the UV lamps to stabilize. Then the oxygen/ozone gas mixture, of known composition and controlled flow rate, is applied to the aliquot, for the predetermined duration of 0.5–60 minutes, preferably 2–5 minutes and most preferably about 3 minutes as discussed above, so

that the aliquot experiences all three stressors simultaneously. In this way, the blood aliquot is appropriately modified according to the present invention sufficient to achieve the desired effects.

Re-injection of the treated blood aliquot into the patient can be accomplished intravenously, intramuscularly, subcutaneously or by other common injection administration methods. Intramuscular reinjection is preferred.

The process of the present invention shows utility both in treating a patient's stress symptoms evident at the time the treatment is administered, and in preconditioning a mammalian patient against the adverse effects of subsequently encountered stress, of any of the aforementioned types. It is not specific to providing tolerance to a specific stress or type of stress, but appears to be of general application. A patient who has undergone a treatment or a series of treatments according to the process of the present invention will exhibit notably reduced adverse reactions to subsequently encountered stress, such as a notably reduced rise in body temperature and/or a reduced increase in heart rate and/or a reduced increase in diastolic blood pressure, in response to stress, as compared with a similar but untreated patient. The process is thus particularly useful for patients who are scheduled to undergo stress such as surgery at a predetermined future date. They can precondition their bodies to be ready for surgery by undergoing a treatment or a series of treatments according to the invention prior to surgery, with the result that they will withstand the surgery better and will recover from it more quickly, thus reducing the time of hospitalization.

Another preferred use of the present invention is in protecting tissues and organs from stress-induced damage, in a manner similar to ischemic preconditioning. As noted previously, repetitive mild ischemic (anginal) episodes can render tissues and organs less susceptible to stress-induced damage, by ischemic preconditioning, although application of ischemic preconditioning by current methods is largely impractical. The process of the present invention can take the place of ischemic preconditioning, ischemia being a species of physical stress. Accordingly, the process of the present invention offers potential for treatment of unstable angina and decrease of infarct size, a treatment not effectively addressed by available therapies.

Similarly, the process of the present invention is applicable in the protection of body organs destined for transplantation. Treatment of the donor body by the process of the present invention serves to protect body organs against damage resulting from the inevitable ischemia which the organ will suffer on removal from the donor body, transportation and subsequent surgical introduction into the recipient body. The treatment according to the invention extends the useful life of the transplant organ between its removal from the donor body and its surgical introduction into the recipient body, thereby reducing losses of viable transplant organs due to transportation delays.

A further, specific clinical application of the process of the invention is in treatment of patients suffering from transient ischemic attacks (TIA's, pre-strokes), which are due to temporary obstruction of blood flow to certain areas of the brain. They commonly indicate the likelihood of suffering a major stroke in the near future. Subjection of such patients to treatment according to the process of the invention, at the onset of TIA's, will precondition the brain to avoid or at least to lessen the severity of the effects of the forthcoming major stroke.

Stressors used to treat the blood aliquot in the process of the present invention and described in the experiments

detailed below are among those known to have the effect of activating the SAP kinase pathway in blood cells. It is suspected that other stressors known to activate the SAP kinase pathway when applied to blood will have similar effects on the blood aliquot in the process of the invention, namely putting the blood aliquot into a condition in which, after re-injection into the patient, it will have beneficial effects on body organs in protecting them against stress as described herein. Such other stressors include gamma radiation and other forms of ionizing radiation, hyperosmolarity, chemotherapeutic agents (cisplatin and mytomycin C, for example), inflammatory cytokines such as TNF $\alpha$  and IL-1, tunicamycin, anisomycin and sodium arsenite. Stress-activated protein kinases (SAPKs), also known as cJun amino-terminal kinases (JNKs), are a family of protein kinases similar to Erk-1 and Erk-2 MAPKs (mitogen-activated protein kinases). They can be activated through their signal transduction pathways (the SAP kinase pathways or SAP/JN kinase pathway) to effect their phosphorylation function. Members of the SAP kinase family include p38 HOG, JNK (Jun N-terminal kinase) and BMK-1. These same stressors are also known to activate the heat shock protein pathway.

Determination of the state of activation of the SAP kinase pathway may be a useful indicator of whether or not an aliquot of blood has been treated according to the process of the invention, rendering it ready for re-injection into the patient for stress-conditioning purposes. There are known, standard methods available and published in the literature for determining activation of the SAP kinase pathway. These include immunoprecipitation with antibodies specific for the individual SAP kinases (JNK, p38 and SAP-K3, for example), followed by phosphotyrosine blotting, which, if positive, indicates SAP kinase pathway activation.

The beneficial effects of the present invention have been demonstrated *in vivo* by clinical experiments on juvenile and adult rats, specifically rats of an inbred strain of genetically hypertensive rats (SHR's). Genetically hypertensive rats (SHR's) are the most widely used animal model for hypertension research, and are well known and readily available to researchers in this field. SHR's have several genetic defects, one of the most important being failure to produce appropriate amounts of HSPs when subjected to stress. SHR's develop hypertension rapidly and exhibit exaggerated increase in heart rate, blood pressure and body temperature in response to stress. They represent a model of hypersensitivity to stress. The results obtained using them provide reliable indications of potential results obtainable with human patients. The effects have also been shown by *in vivo* clinical experiments on dogs, detailed below in Example 8.

#### EXAMPLE 1

Blood from sacrificed SHR's of the same strain as the test animals was collected, treated with sodium citrate anticoagulant and pooled. A portion of the blood was then placed in a sterile container, and subjected simultaneously to the UV radiation, ozone/oxygen gas oxidative environment and elevated temperature stressors, in an apparatus as generally described in the aforementioned Mueller U.S. Pat. No. 4,968,483. More specifically, the blood sample in the sterile, UV-transparent container was heated using infrared lamps to 42.5° C., and whilst being maintained at that temperature, it was subjected to UV radiation of wavelength 253.7 nm under the preferred conditions previously described. Simultaneously, a gaseous mixture of medical grade oxygen and ozone, of ozone content 13.5–15.5  $\mu$ g/ml, was bubbled

through the blood sample at a rate of flow over a range from 60–240 ml/min. The time of simultaneous UV exposure and gas mixture feed was 3 minutes.

A further portion of the pooled blood, to act as a control, was similarly placed in a sterile container and placed in the aforementioned apparatus, but was not heated, nor subjected to UV radiation nor subjected to application of any ozone/oxygen gas mixture. In addition, to provide a further control, a sterile aqueous physiological saline solution was prepared.

A total of 44 seven week old SHR's were selected and divided into three groups, group A containing 15 animals, group B containing 15 animals, and group C containing 14 animals. For a period of 10 days (at 7–9 weeks of age), each animal of group A received a daily intraguteal injection of 150  $\mu$ l of the UV, heat and ozone treated blood. Each animal of group B received at the same time a similar daily injection of the untreated blood. Each animal of group C received at the same time a similar injection of physiological saline.

At the age of 9 weeks, 4 days after completion of the injections the animals were anaesthetized and, a telemetry probe was inserted surgically into the femoral artery of each animal. The telemetry probe (trade-mark DATAQUEST LABPRO, available from Data Sciences International) is a commercially available probe equipped with a radio transmitter, to permit heartbeat, systolic blood pressure, diastolic blood pressure and other signals to be received and recorded without further handling of the animals, which might induce further, uncontrolled stress reactions. An additional probe was surgically inserted into the peritoneal cavity of each animal, to measure body temperature.

Continuous daily recordings of body temperature, blood pressure and heart rate were made from each animal, during the 10 day period following the surgery, readings being taken during the inactive, at-rest portion of the animals' daily cycle, i.e. the daylight ("light-on") portion, and during the activity time (night). Group A animals which received injections of blood treated according to the process of the invention demonstrated a significantly more rapid recovery of normal body temperature following surgery (6 days vs. 10 days), as compared with group B animals which received untreated blood and group C animals which received saline injections, as shown especially by the readings taken during the resting periods. The differences are less evident from night-time, activity phase readings, suggesting that the higher cortisol levels present during activity may have an influence on the results. This demonstrates a significant effect of the treatment of the present invention on lessening the mammalian body's response to the stress of surgery.

The results of these experiments are presented graphically on FIG. 1, a plot of measured body temperatures against days after surgery, each plotted value being the mean of values obtained from the whole group during the at-rest periods. Curve A is derived from group A animals, curve B from group B animals and curve C from group C animals. The results of the saline-injected group and the untreated blood group (B v C) are not significantly different (P-value 0.6764). The results from the treated blood group are, however, significantly different (A v B,  $p=0.008$ ; A v C,  $p=0.0002$ ).

#### EXAMPLE 2

The 44 animals treated as described in Example 1, namely the Group A of 15 animals which had received injections of blood treated according to the process of the invention, Group B of 15 animals which had received injection of untreated blood, and Group C which had received injection

of saline, 10 days after the probe implantation surgery described in Example 1, were subjected to psychological stress through standard immobilization stress test, by placing them in small restraint cages for a period of 30 minutes (age of animals—11 weeks). During this immobilization period, readings of body temperature, blood pressure and heart rate, at one minute intervals, were recorded.

Accompanying FIG. 2 of the drawings is a graphical presentation of the results of the body temperature measurements of the three groups, namely a plot of time as ordinate against body temperature as abscissa over the 30 minute duration of the immobilization stress test. As FIG. 2 shows, curve 2A derived from experimental Group A is consistently and significantly below curve 2B obtained from control Group B and curve 2C obtained from control Group C. Statistical analysis of all the data obtained confirms the high significance of the differences in the figures obtained from experimental Group A.

FIG. 3 of the accompanying drawings presents graphically the results of heart rate measurements on the three groups, with heart rate (beats per minute, bpm) plotted as ordinate against time of the stress test. Again, the results (averaged over the animals in each group) show that the group which received the injections of blood treated according to the invention, Group A, had a lower increase in heart rate, as compared with the other two groups, over substantially the entire duration of the test. The differences between the respective groups are statistically significant— $p=0.0001$  in each case.

FIG. 4 of the accompanying drawings presents graphically the results of the measurements of diastolic blood pressure of each of the three test groups, with diastolic blood pressure (mmHg) plotted as ordinate against time of the stress test. Again, the values from Group A (averaged), the group which had received injections of blood treated according to the invention, are consistently and significantly ( $p=0.0001$  in each case) lower than those from the other two groups.

#### EXAMPLE 3

The Group C animals from Example 2, i.e. the control group which had, at age 7–9 weeks, received injections of physiological saline, were divided into three sub-groups Ca, Cb, and Cc. Each group was given a course of 10 daily injections of, respectively, 150  $\mu$ l of the treated blood, 150  $\mu$ l of the untreated blood, and 150  $\mu$ l of physiological saline. The course of injection started when the animals were 12 weeks old, i.e. fully matured adults. The telemetry probes remained in place. The same 30 minute immobilization stress test was performed on each animal, at age 16 weeks, and measurement of heart rate, blood pressure and body temperature were taken.

In body temperature response, the group Ca injected with blood treated according to the process of the invention showed a significantly more blunted increase during the stress period. This is illustrated in FIG. 5, a graphical presentation of the results similar to FIG. 2. It can be seen that curves Ca, derived from the Group Ca animals, is consistently lower than curve Cb derived from Group Cb animals and consistently lower than curve Cc derived from Group Cc animals. The treated blood v untreated blood results, and the treated blood v saline results are statistically significant— $p=0.0001$  in each case.

#### EXAMPLE 4

The Group A experimentally treated animals from Example 2 which had received injections of blood treated

according to the invention at age 7–9 weeks were divided into three sub-groups, labelled Aa, Ab and Ac, five animals in each group. They were then subjected to a second series of 10 daily injections of 150  $\mu$ l of, respectively, the treated blood, the untreated blood and the physiological saline. The course of injections started when the animals were 12 weeks old. The telemetry probes were left in place from Example 1, so that the surgery did not need to be repeated. The animals were then subjected again, at 16 weeks of age, to the same immobilization stress test as described in Example 2 for 30 minutes, and measurements taken at 1 minute intervals of heart rate, blood pressure and body temperature.

The differences between the groups with regard to body temperature rise were very significant. They are illustrated on FIG. 6, a plot of body temperature against time, based on averages, similar to FIG. 2. After about the 12th minute of the test, group Aa which had received 2 courses of injection with the blood treated according to the invention exhibited consistently and significantly ( $p=0.0019$  or less in each case) the lowest rise in body temperature. Curve Aa derived from Group Aa is consistently below curve Ab derived from Group Ab and curve Ac derived from Group Ac. It will be observed that the values on curve Aa are also lower than those on curve A of FIG. 2, indicating that a second treatment according to the invention has additional benefits on conditioning the animals for tolerance of stress. In contrast, the values on curve Ac are higher than the values on curve A of FIG. 2, and lower than the values on curve C of FIG. 2, indicating that the effects of the treatment tend to be lost after about 24 days from the conclusion of the course of treatment, absent a second “booster” treatment according to the invention.

#### EXAMPLE 5

The stress responses of animals from Example 1 which had been given two courses of injection with the same fluid (saline followed by saline, untreated blood followed by untreated blood, and treated blood followed by treated blood), at 7 weeks of age and 12 weeks of age, were measured during a second immobilization stress test, conducted as previously described, on animals aged 16 weeks. The results obtained from body temperature measurements are shown on FIG. 7, a graph of body temperature against time during the 30-minute stress test, similar to FIG. 2. Curve AA is derived from the measurements (average of 5 animals) of animals which had received two courses of ten daily injections of blood treated according to the invention. Curve BS is derived from the measurements (average of 5 animals) of animals which received two such courses of injections of untreated blood. Curve CC is derived from the measurements (average of 5 animals) of animals which received two such courses of saline injections. As the Figure shows, the values obtained from animals treated according to the process of the present invention are consistently and significantly ( $p=0.0001$ ) lower than those derived from the other two groups.

FIG. 8 of the accompanying drawings similarly presents the heart rate measurements for the three groups, during the stress test. Again, Curve AA derived from animals which had received two courses of injection of blood treated according to the invention is significantly ( $p=0.0001$ ) lower than the other two curves.

#### EXAMPLE 6

In further demonstrations of the use of the process of the present invention in preconditioning mammalian body

organs and tissues against the adverse effects of ischemic stress and subsequent reperfusion, experiments were performed on genetically hypertensive rats (SHRs), of the type previously described, by inducing ischemia in the animals' kidneys after they had been treated by the process of the invention. The procedure was as follows:

A group of 63 SHRs was divided into two approximately equal sub-groups, A and B. Sub-group A was given two courses of injections of blood from the pool described in Example 1, the injected blood having been treated with ultraviolet light, ozone-oxygen gas and elevated temperature stressors simultaneously, also as described in Example 1. The first course of injections started at age 7 weeks, and comprised 10 injections, over a period of 10 days, of a 150  $\mu$ l aliquot of the treated blood intraglutely injected. The second course of injections commenced at age 12 weeks, and comprised 10 injections, administered daily, of the same volumes of treated blood administered in the same manner. The animals of sub-group B were given injections of physiological saline, at the same times and in the same quantities, and thus acted as controls.

One day following the second course of injections, the rats were anaesthetized under light gas anaesthesia, and the right kidney of each animal was removed through back incision. An occlusive clip was placed on the remaining renal artery and vein, to expose the left kidney to transient ischemia, for 60 minutes. The skin was temporarily closed by clips. The animals were then followed with respect to the degree of injury resulting from the ischemia and/or the subsequent reperfusion, by taking blood samples for determining serum creatinine and blood urea nitrogen (BUN) and by determining survival rates. After taking the initial blood sample, the skin was definitively closed.

The survival rate was monitored by daily count of survivors. After 14 days, 55% of the sub-group A animals which had received the treated blood injections were surviving, compared with only 32% of the sub-group B, saline—saline treated animals. The survival rates are shown in more detail on accompanying FIG. 9, a plot of percentage of survivors as ordinate against days after renal ischemia as abscissa. On FIG. 9, the solid line derives from the results from the animals of sub-group A, and the dotted line derives from the results from the animals of sub-group B.

The results show a significant ( $p < 0.05$ , log rank test), improvement in animals which received treatment according to the invention, indicating successful preconditioning against injury resulting from the ischemia and/or the subsequent reperfusion, by the process of the invention.

Blood samples of volume 100–200  $\mu$ l were taken from the surviving re-perfused animals at days 1, 3, 6 and 12 after the ischemia, from the tail artery, and were analysed for creatinine content and for blood urea nitrogen (BUN) content. High creatinine content indicates impaired renal function, in that kidneys are not functioning to clear creatinine content from the blood adequately. BUN content is similarly a measure of the efficiency of renal function—the lower the BUN and creatinine content of the blood, the more efficient the renal function. Both tests are standard determinations of renal function in mammalian patients.

FIG. 10 of the drawings is a graphical presentation of the results of the BUN content determinations, averaged over each group of animals. Each curve is a plot of BUN values against days after ischemia. Curve 10B is derived from control sub-group B animals, curve 10A from sub-group A animals which received the treated blood. At day 6, the average BUN value for sub-group A animals was significantly lower ( $p < 0.025$ ).

FIG. 11 of the accompanying drawings similarly gives a graphical presentation of the results of serum creatinine measurements, with the averaged curve 11A from the treated, sub-group A animals being consistently and significantly lower than the averaged curve from the control sub-group B animals, at days 1, 3 and 6 ( $p < 0.025$ ). These results show consistently lower creatinine levels and lower BUN levels in samples from animals receiving treatment according to the invention, demonstrating that the treatment effectively preconditions the individual organs and tissues of the body for better resistance to subsequent ischemia stress and/or reperfusion injury.

The increase in creatinine and BUN in each sub-group peaked at day 3, with a return to basal values at day 12. This peak increase in the sub-group A animals is significantly lower. Six days after ischemia/reperfusion, the levels of both creatinine and BUN in the samples from the sub-group A animal are about half those in the samples from the control animals. In the first 24 hours after ischemia, 83% of the rats in control sub-group B were oliguric (less than 2 ml of urine passed in 24 hours) whereas oliguria was present in only 42% of the sub-group A rats ( $p < 0.01$ ). This is shown in accompanying FIG. 12, a bar plot of number of animals in each group passing urine during the 24 hours after renal ischemia/reperfusion in volume appropriate to classify the animals as oliguric, mildly oliguric or normal. The solid bars on FIG. 12 derive from the animals of sub-group A, the open bars from the animals of sub-group B.

#### EXAMPLE 7

SHR male rats, 60 in total, were divided into five groups of 12 animals per group. Samples of pooled blood from sacrificed SHR rats of the same strain were given four different stressor treatments as described in Example 1 but using the following, simultaneously applied stressor combinations:

1. bubbling  $O_2/O_3$  gas mixture while being subjected to UV light at elevated temperature of 42.5° C. maintained by IR lamps;
2. bubbling  $O_2/O_3$  gas mixture while being subjected to UV light;
3. bubbling  $O_2/O_3$  gas mixture while being maintained at elevated temperature (42.5° C.) by IR lamps; and
4. bubbling  $O_2$  gas while maintained at 42.5° C. by IR lamps and being subjected to UV light (this does not constitute an oxidative environment).

The stressor quantities, times, intensities etc. were as detailed in Example 1.

The treated blood samples were administered to the respective groups 1, 2, 3 and 4 of animals, group 5 receiving physiological saline in the same quantities and at the same regimen, namely, intramuscular injection of 150  $\mu$ l daily for a first course of 10 days commencing when the animals were 7 weeks old, and a second, similar course for 10 days when the animals were 12 weeks old. This is described in Example 6.

One day following the completion of the second course of injection, the animals were anaesthetized and subjected to uninephrectomy as in Example 6. The remaining left kidney was exposed to transient ischemia for 60 minutes by occluding the remaining renal artery. Survival rates were monitored for 8 days after ischemia and reperfusion. Urinary outputs were measured during the 24 hours following surgery.

FIG. 13 of the accompanying drawings shows the survival rates of animals in the various groups, 8 days after surgery. Group 5, the control group which received saline injections



had only a 25% survival rate, with all of the other groups significantly better. Group 2 which received blood treated with the oxidative stressor and UV light, was particularly good, with a 75% survival rate, indicating very good preconditioning to withstand subsequently encountered ischemic-reperfusion stresses.

FIG. 14 of the accompanying drawings presents the results of urine output measurements, with an output of 6 ml or less of urine during the 24 hour period following surgery being determinative of oliguric animals, i.e. seriously impaired or non-existent kidney function. The number of oliguric animals is presented on the vertical axis. The highest number of oliguric animals is observed in the control group 5, with all groups treated according to the present invention significantly improved.

#### EXAMPLE 8

The experimental procedure of Example 6 demonstrating the use of the process in preconditioning against ischemic stress and reperfusion in an ischemic *in vivo* kidney test, was performed on experimental dogs, namely pure-bred normal beagles age 1–2 years, equal numbers of males and females in each group and sub-group.

Thus the animals were separated into four groups, A, B, C and D, each group consisting of 6 animals, 3 males and 3 females. Animals of groups A and C were subjected to the process of the invention, by being two 10-day courses of daily blood aliquot (3 ml) removal, extracorporeal treatment of the blood aliquot with ozone/oxygen, UV radiation and heat as described in Example 6, and re-administration of the treated aliquot to the same animal, by intramuscular injection. Each animal experienced a three-week rest period between the 10-day courses of treatment. Groups B and D were control groups, given two 10-day courses of daily injections of 3 ml of physiological saline, with a three-week rest period between the 10-day courses.

One day following the second course of injections, the animals were anaesthetized under light gas anaesthesia, and the right kidney of each animal was removed through back incision. An occlusive clip was placed on the remaining renal artery and vein, to expose the left kidney to transient ischemia, for 60 minutes. Blood samples were subsequently taken from the animals, and analysed for creatinine and blood urea nitrogen, the indicators of impaired renal function as described in Example 6.

The creatinine results are presented graphically on accompanying FIG. 15, a plot of blood creatinine content against time, over a period of 6 days following ischemia. Curve AC, of results obtained from group A and group C animals, is consistently lower than curve BD of results from control groups B and D, indicating significantly better renal functional for the dogs treated by the process of the invention. The notation ARF indicates acute renal failure. The changes over time within groups are highly significant ( $p < 0.0001$ ).

Injury to an organ subjected to ischemia can occur as a consequence of the ischemia alone (e.g. in cases where ischemia is caused by a blood clot which is subsequently dissolving, but blood does not flow back into the affected area of the organ after the clot is dissolved—the so-called “no-reflow” phenomenon), or by the subsequent reperfusion of the organ with blood after ischemia, when leukocytes or free radicals or the like may damage the blood vessels and cells of the organ. The term “injury resulting from ischemia and/or reperfusion” and the term “ischemia/reperfusion injury” as used herein cover both types of injury, occurring alone or in combination.

The above results of the procedure of the present invention can protect the kidney from injury resulting from ischemia and/or reperfusion, as measured by survival rate, blood urea and creatinine levels and urinary flow in the SHR. This indicates use of the procedure in protecting body organs in general from ischemia/reperfusion injury, including the heart, the liver, the brain, the spinal cord and other vital organs and tissues as well as the kidney, and indicates practical application of the procedure on patients scheduled to undergo surgical procedures involving ischemia/reperfusion of a body organ, such as surgical repair, removal or transplantation of a body organ.

In particular, ischemic acute renal failure is an important clinical problem with high morbidity and high mortality. The process of the present invention presents a novel approach to combatting this disorder. It can be adopted prior to kidney transplantation, on either or both the donor or recipient. It can be adopted prior to kidney revascularization. It can be adopted prior to invasive evaluation in high risk subjects, e.g. angiography in diabetics. It can be adopted prior to abdominal aortic surgery such as aortic aneurism repair and renal bench surgery (i.e. where the kidney is temporarily removed and operated on *ex vivo*, and then re-implanted).

As regards its use in connection with procedures involving the heart, the procedure of the invention can be conducted prior to coronary angioplasty, and bypass, or prior to transplantation, as in the case of the kidney. It is indicated for use with patients about to undergo open heart surgery with cardio-pulmonary bypass for coronary artery bypass grafting, valve replacement or surgical repair of congenital or acquired cardiac structural abnormalities. In the case of the brain or other vital organs and tissues including the intestines, the kidneys and limbs, the procedure of the invention can be used prior to angioplasty or endarterectomy, in high risk subjects.

The use of the process of the present invention prior to general anaesthesia in connection with major surgery can be viewed as general pre-conditioning of the body, to better withstand ischemia-reperfusion injuries to which the major organs will later be subjected. It is indicated for use prior to conducting major surgical procedures involving general anaesthesia in patients known to have or likely to have a significant degree of underlying atherosclerosis in the arteries supplying the brain, heart, liver, intestine, spinal cord, kidneys or limbs, the atherosclerosis rendering them more susceptible to a thrombo-ischemic event in the operative or post-operative period. Such similar general pre-conditioning of the body by the process of the invention is also indicated for use in alleviating the effects of subsequently encountered shock, leading to under-perfusion of vital organs and tissues through failure to cardiac action loss of blood or other body fluids, excessive dilation of blood vessels and excessively low blood pressure. Examples include major blood loss, trauma, sepsis and cardiogenic shock. Individuals likely to be exposed to such hazards, including patients awaiting surgery, rescue and relief crews for natural disasters, would be beneficiaries of the process of the invention.

Other areas of utility of the procedure of the present invention, in connection with preconditioning of a patient body and body organ prior to subjection to stress, e.g. ischemic stress as part of a surgical procedure, general psychological stress or physiological stress, as part of surgery or other foreseeable stress-situations, will be apparent to those skilled in the art.

#### References

1. Gersh, B. J., Braunwald, E., and Rutherford, J. D.: Mechanism of Cardiac Contraction and Relaxation. In:

"Heart Disease: Textbook of Cardiovascular Medicine" Braunwald, E. Ed. W. B. Saunders Company, Philadelphia, 5th Edition, pages 360-393, 1997.

What is claimed is:

1. Process for preconditioning a mammalian patient to better withstand the adverse effects of ischemic stress encountered following subsequent surgery which results in ischemia-reperfusion of cells, tissues and/or a body organ of the patient, which comprises:

extracting an aliquot of the patient's blood;

subjecting said aliquot of blood extracorporeally to at least one stressor selected from an oxidative environment, UV radiation and elevated temperature up to about 45° C., and injecting the so-treated aliquot of blood into the patient.

2. The process according to claim 1 wherein the blood aliquot is of volume about 0.1 ml to 400 ml.

3. The process according to claim 2 wherein the chosen stressor or combination of stressors is applied to the blood aliquot for a period of time from 0.5-60 minutes.

4. The process according to claim 3 wherein the oxidative environment stressor to which the blood aliquot is subjected is a mixture of medical grade oxygen and ozone, with an ozone content from about 0.1-100 µg/ml.

5. The process according to claim 3 wherein the ultraviolet radiation stressor is ultraviolet radiation from UV lamps emitting primarily at wavelengths of 280 nm or shorter.

6. The process according to claim 3 wherein the elevated temperature stressor is a temperature in the range from about 38-43° C.

7. The process according to claim 3 wherein the aliquot of blood is subjected to the oxidative environment stressor and the UV radiation stressor simultaneously.

8. The process according to claim 3 wherein the aliquot of blood is subjected to the oxidative stressor and the elevated temperature stressor simultaneously.

9. The process according to claim 3 wherein the aliquot of blood is subjected to the UV radiation stressor and the elevated temperature stressor simultaneously.

10. The process according to claim 3 wherein the blood aliquot is subjected to all three said stressors simultaneously.

11. The process according to claim 10 wherein the elevated temperature stressor is applied by infra-red radiation.

12. Process for protecting mammalian donor organs destined for transplantation from a mammalian donor to a mammalian recipient, which comprises extracting an aliquot of blood from the donor, subjecting the aliquot of extracorporeally to at least one stressor selected from an oxidative environment, UV radiation and elevated temperature up to about 45° C., and injecting the so-treated aliquot of blood into the donor prior to the removal of the organ therefrom.

13. The process according to claim 1 wherein the ischemic stress is ischemia-reperfusion of the patient's kidney, heart, liver, intestine, spinal cord or brain.

14. The process according to claim 1 wherein the ischemic stress is ischemia-reperfusion of the kidney.

15. The process according to claim 1 in which the patient suffers from atherosclerosis and is scheduled for general anaesthesia prior to ischemia of a vital organ in a surgical procedure.

16. The process according to claim 1 in which the patient is scheduled to undergo open-heart surgery or heart transplantation with cardio-pulmonary bypass.

17. The process according to claim 1 which comprises subjecting an aliquot of the mammalian patient's blood extracorporeally to infrared radiation, and reinjecting the so-treated blood aliquot into the patient.

18. The process according to claim 1 wherein the patient is scheduled to undergo aortic aneurysm repair.

19. The process according to claim 17 wherein the aliquot of blood is subjected extracorporeally to infra-red radiation in combination with an oxidative environment and/or UV radiation.

20. The process according to claim 1 in which the patient suffers from atherosclerosis and is scheduled for surgery.

21. The process according to claim 20 comprising a plurality of injections of blood aliquots which have been subjected to said stressors, administered at intervals of at least once per day.

22. The process according to claim 10 wherein the oxidative environment stressor to which the blood aliquot is subjected is a mixture of medical grade oxygen and ozone, with an ozone content from about 0.1-100 µg/ml, the ultraviolet radiation stressor is ultraviolet radiation from UV lamps emitting primarily at wavelengths of 280 nm or shorter, and the elevated temperature stressor is a temperature in the range from about 38-43° C.

23. The process according to claim 12 wherein the blood aliquot is of volume about 0.1 ml to 400 ml.

24. The process according to claim 23 wherein the chosen stressor or combination of stressors is applied to the blood aliquot for a period of time from 0.5-60 minutes.

25. The process according to claim 24 wherein the oxidative environment stressor to which the blood aliquot is subjected is a mixture of medical grade oxygen and ozone, with an ozone content from about 0.1-100 µg/ml.

26. The process according to claim 24 wherein the ultraviolet radiation stressor is ultraviolet radiation from UV lamps emitting primarily at wavelengths of 280 nm or shorter.

27. The process according to claim 24 wherein the elevated temperature stressor is a temperature in the range from about 38-43° C.

28. The process according to claim 24 wherein the aliquot of blood is subjected to the oxidative environment stressor and the UV radiation stressor simultaneously.

29. The process according to claim 24 wherein the aliquot of blood is subjected to the oxidative stressor and the elevated temperature stressor simultaneously.

30. The process according to claim 24 wherein the aliquot of blood is subjected to the UV radiation stressor and the elevated temperature stressor simultaneously.

31. The process according to claim 24 wherein the blood aliquot is subjected to all three said stressors simultaneously.

32. A process of preconditioning a mammalian patient susceptible to psychological stress, to better withstand the adverse effects of subsequently encountered psychological stresses, which comprises:

selecting a patient susceptible to psychological stress;

extracting an aliquot of said selected patient's blood;

subjecting said aliquot extracorporeally to at least one stressor selected from the group consisting of an oxidative environment, UV radiation and elevated temperature up to about 45° C.; and

injecting the so-treated aliquot of blood into said selected patient.

33. The process according to claim 32 wherein the blood aliquot is of volume about 0.1 ml to 400 ml.

34. The process according to claim 33 wherein the chosen stressor or combination of stressors is applied to the blood aliquot for a period of time from 0.5-60 minutes.

35. The process according to claim 34 wherein the oxidative environment stressor to which the blood aliquot is subjected is a mixture of medical grade oxygen and ozone, with an ozone content from about 0.1-100 µg/ml.

17

36. The process according to claim 34 wherein the ultraviolet radiation stressor is ultraviolet radiation from UV lamps emitting primarily at wavelengths of 280 nm or shorter.

37. The process according to claim 34 wherein the elevated temperature stressor is a temperature in the range from about 38–43° C.

38. The process according to claim 34 wherein the aliquot of blood is subjected to the oxidative environment stressor and the UV radiation stressor simultaneously.

18

39. The process according to claim 34 wherein the aliquot of blood is subjected to the oxidative stressor and the elevated temperature stressor simultaneously.

40. The process according to claim 34 wherein the aliquot of blood is subjected to the UV radiation stressor and the elevated temperature stressor simultaneously.

41. The process according to claim 34 wherein the blood aliquot is subjected to all three said stressors simultaneously.

\* \* \* \* \*



US007223391B2

(12) **United States Patent**  
**Bolton**

(10) **Patent No.:** **US 7,223,391 B2**  
(45) **Date of Patent:** **May 29, 2007**

(54) **METHOD FOR TREATING MAMMALS WITH MODIFIED MAMMALIAN BLOOD**

(75) Inventor: **Anthony E. Bolton**, Ontario (CA)

(73) Assignee: **Vasogen Ireland Limited**, Shannon, County Clare (IE)

(\* ) Notice: Subject to any disclaimer, the term of this patent is extended or adjusted under 35 U.S.C. 154(b) by 0 days.

(21) Appl. No.: **11/150,084**

(22) Filed: **Jun. 10, 2005**

(65) **Prior Publication Data**

US 2005/0238623 A1 Oct. 27, 2005

**Related U.S. Application Data**

(63) Continuation of application No. 09/564,853, filed on May 5, 2000, now Pat. No. 6,986,888.

(30) **Foreign Application Priority Data**

May 6, 1999 (CA) ..... 2271190

(51) **Int. Cl.**

**A01N 39/00** (2006.01)  
**A01N 35/14** (2006.01)  
**C12N 5/06** (2006.01)

(52) **U.S. Cl.** ..... **424/93.7; 424/278.1; 424/529; 424/613; 435/372; 435/375; 435/377**

(58) **Field of Classification Search** ..... **424/613; 424/810, 93.21, 278.1**

See application file for complete search history.

(56) **References Cited**

**U.S. PATENT DOCUMENTS**

4,968,483 A 11/1990 Mueller et al.

5,591,457 A 1/1997 Bolton  
5,834,030 A 11/1998 Bolton  
5,980,954 A 11/1999 Bolton  
6,136,308 A 10/2000 Tremblay et al.  
6,572,895 B2 \* 6/2003 Smith et al. .... 424/529

**FOREIGN PATENT DOCUMENTS**

WO WO 96/34613 11/1996  
WO WO 98/07436 2/1998  
WO WO 99/13890 3/1999  
WO WO 00/29003 5/2000  
WO WO 00/62788 10/2000

**OTHER PUBLICATIONS**

Sweeney et al. *J. Leukoc. Biol.* 62(4):517-23 (Oct. 1997).  
The Merck Manual of Diagnosis and Therapy, Seventeenth Edition, 1999, pp. 416-122 and pp. 1654-1658.  
Van Noort et al. *International Review of Cytology* 178:127-205 (1998).

\* cited by examiner

*Primary Examiner*—Christina Chan  
*Assistant Examiner*—Phuong Huynh  
(74) *Attorney, Agent, or Firm*—Voley & Lardner LLP

(57) **ABSTRACT**

An improved method for treating or preventing a pathological condition in a mammalian subject in which modified mammalian blood is administered to the subject. The method comprises administering to the subject from two to four aliquots of modified mammalian blood, with the administration of any pair of consecutive treatments either being on consecutive days or being separated by a rest period of 1 to 21 days. The treatment is useful for treating or preventing a wide range of pathological conditions in which modified mammalian blood is effective, including preconditioning a mammalian subject to better withstand the adverse effects of ischemic stress, atherosclerosis and rheumatoid arthritis.

**5 Claims, 6 Drawing Sheets**

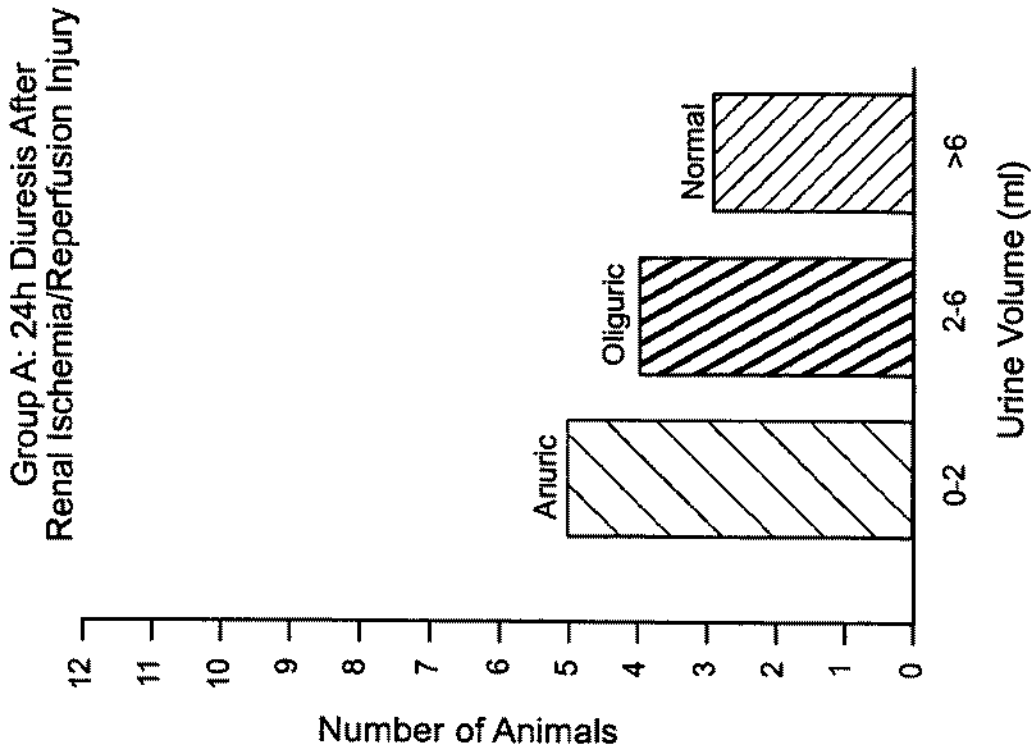


FIG.-2

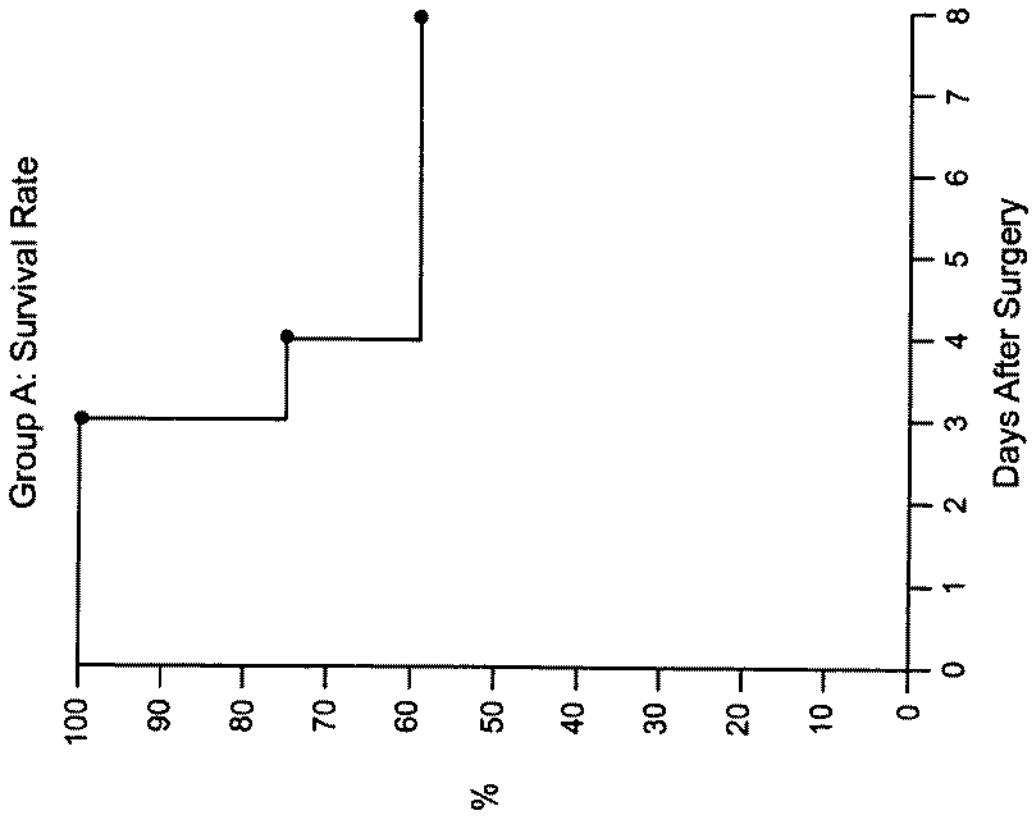


FIG.-1

Group E: 24h Diuresis After Renal Ischemia/Reperfusion Injury

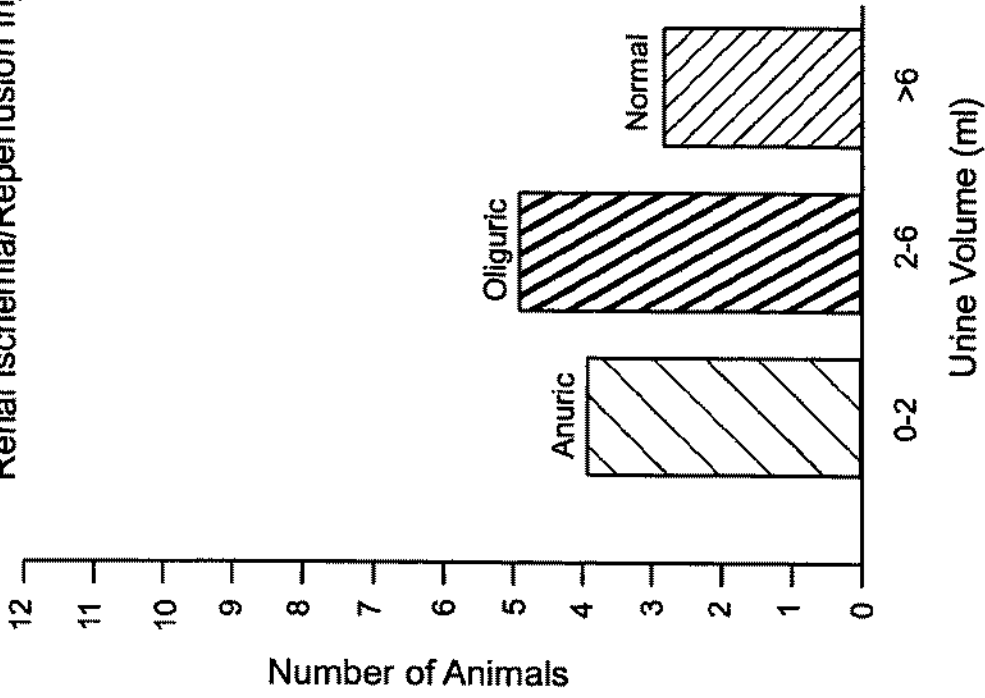


FIG.\_4

Group E: Survival Rate

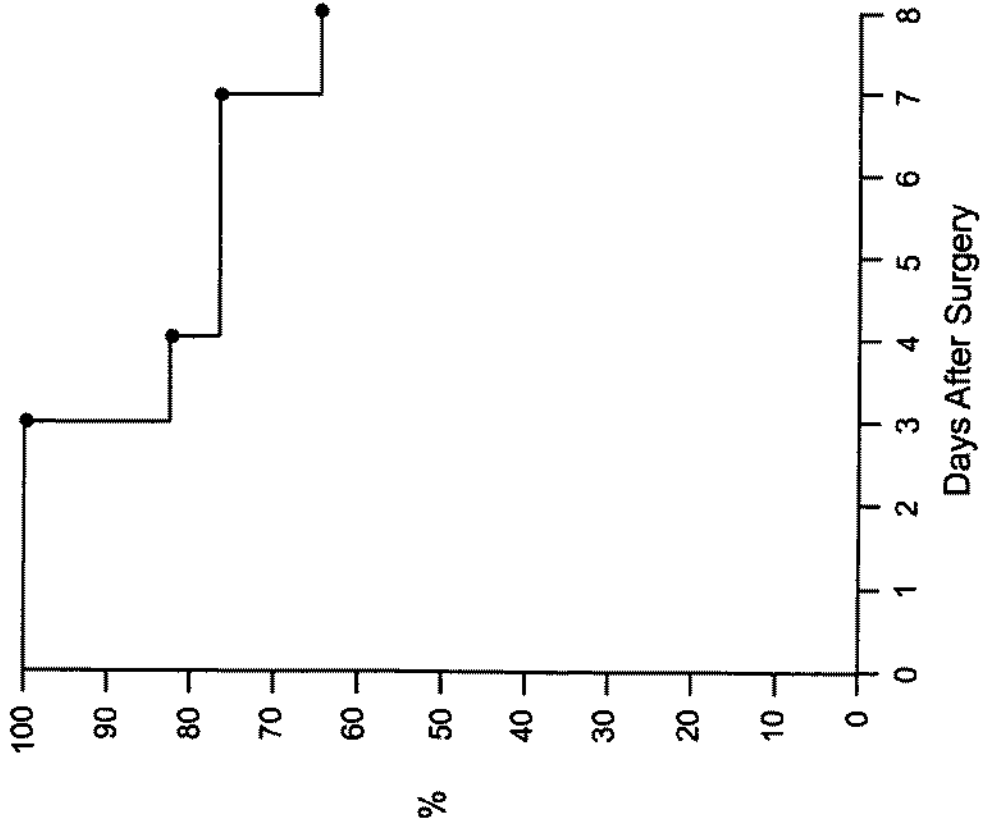


FIG.\_3

Group F: 24h Diuresis After Renal Ischemia/Reperfusion Injury

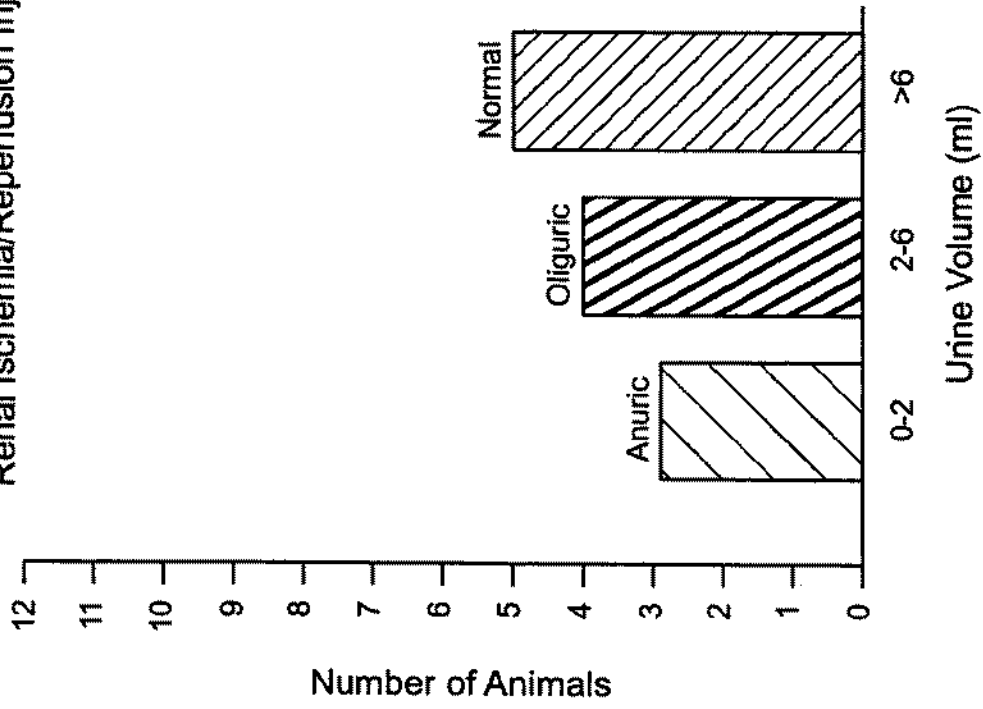


FIG.\_6

Group F: Survival Rate

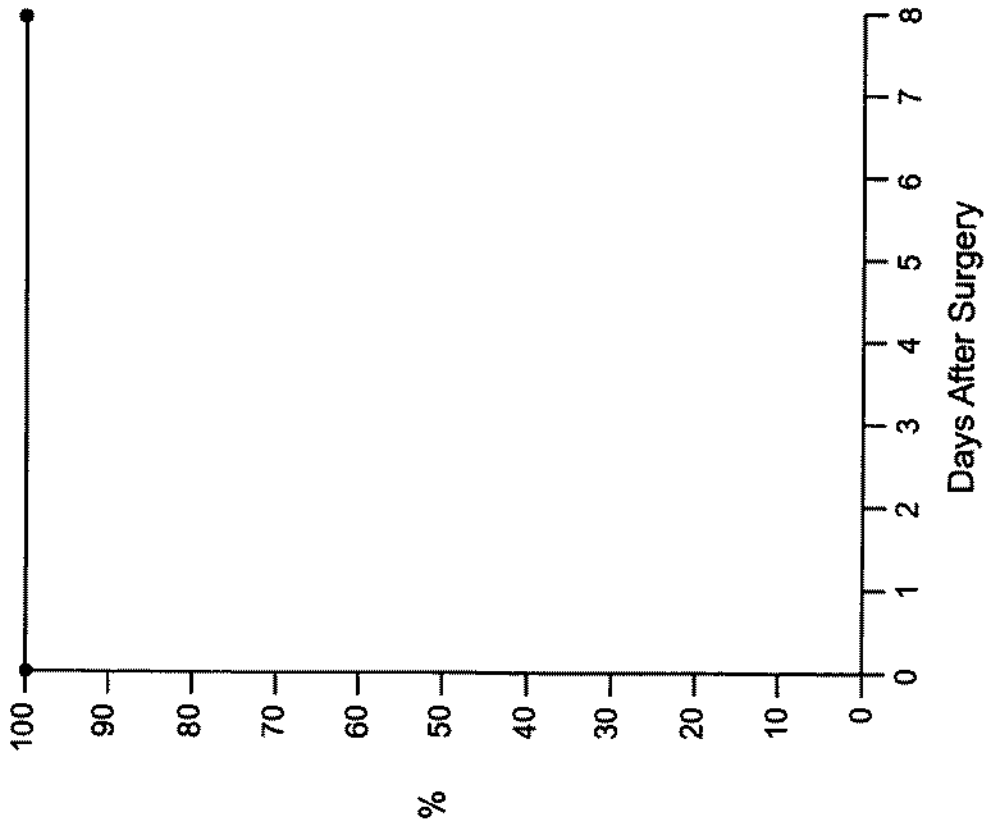


FIG.\_5

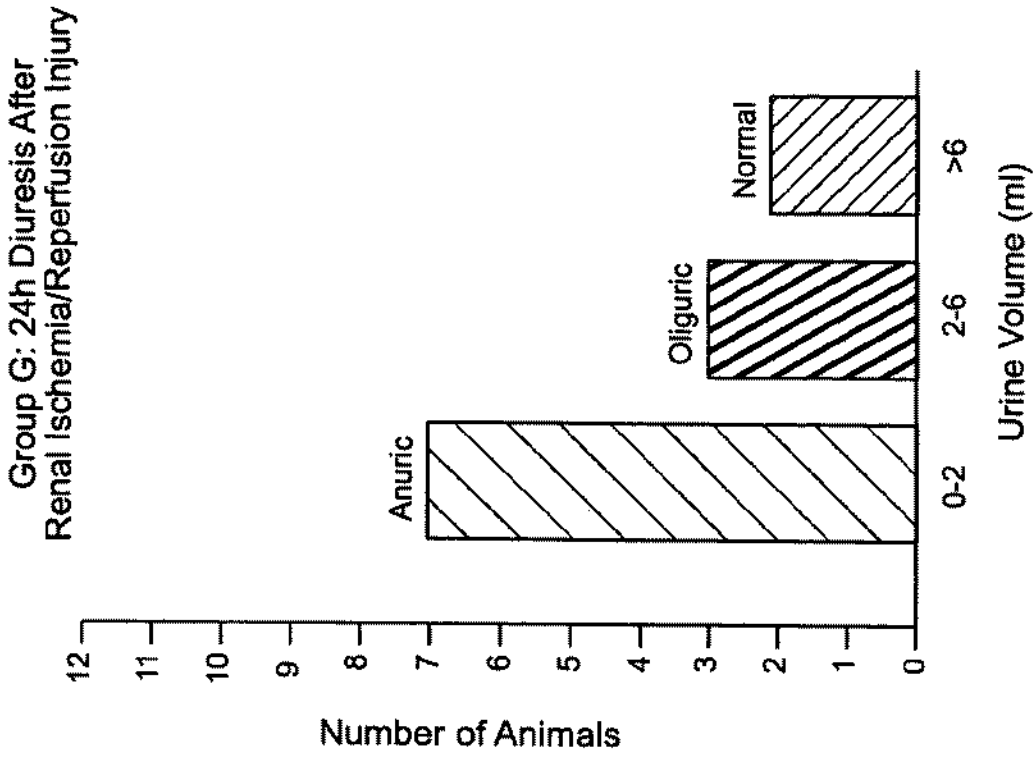


FIG.\_8

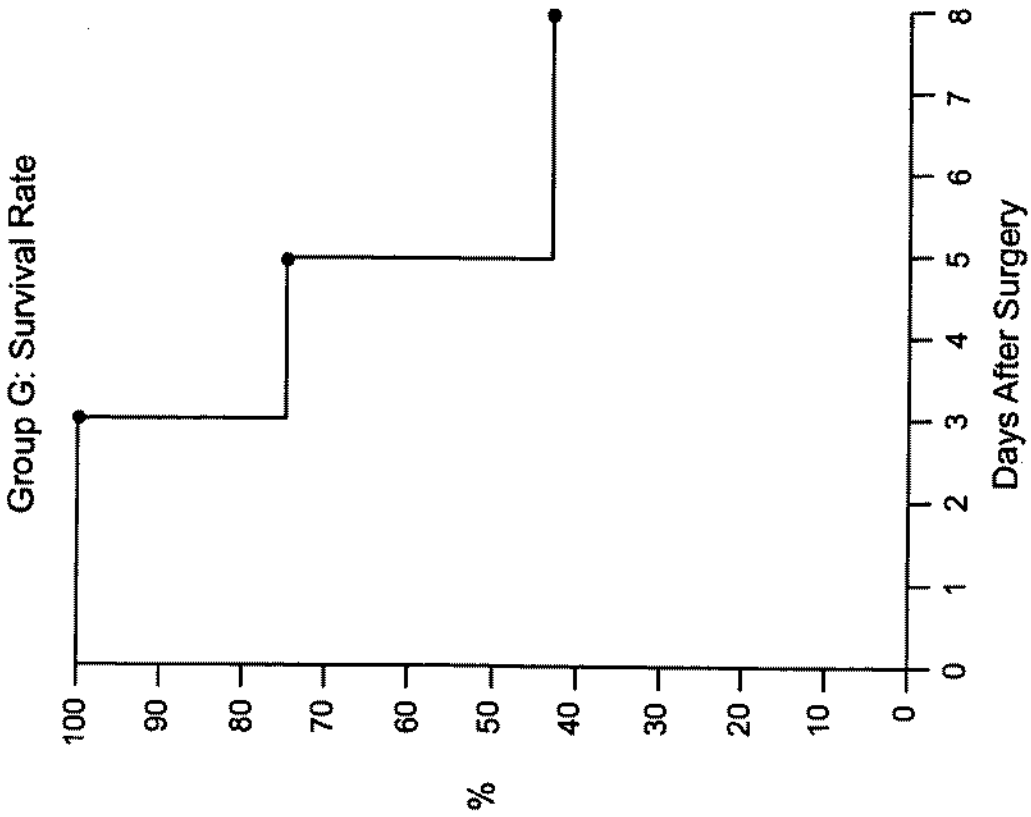
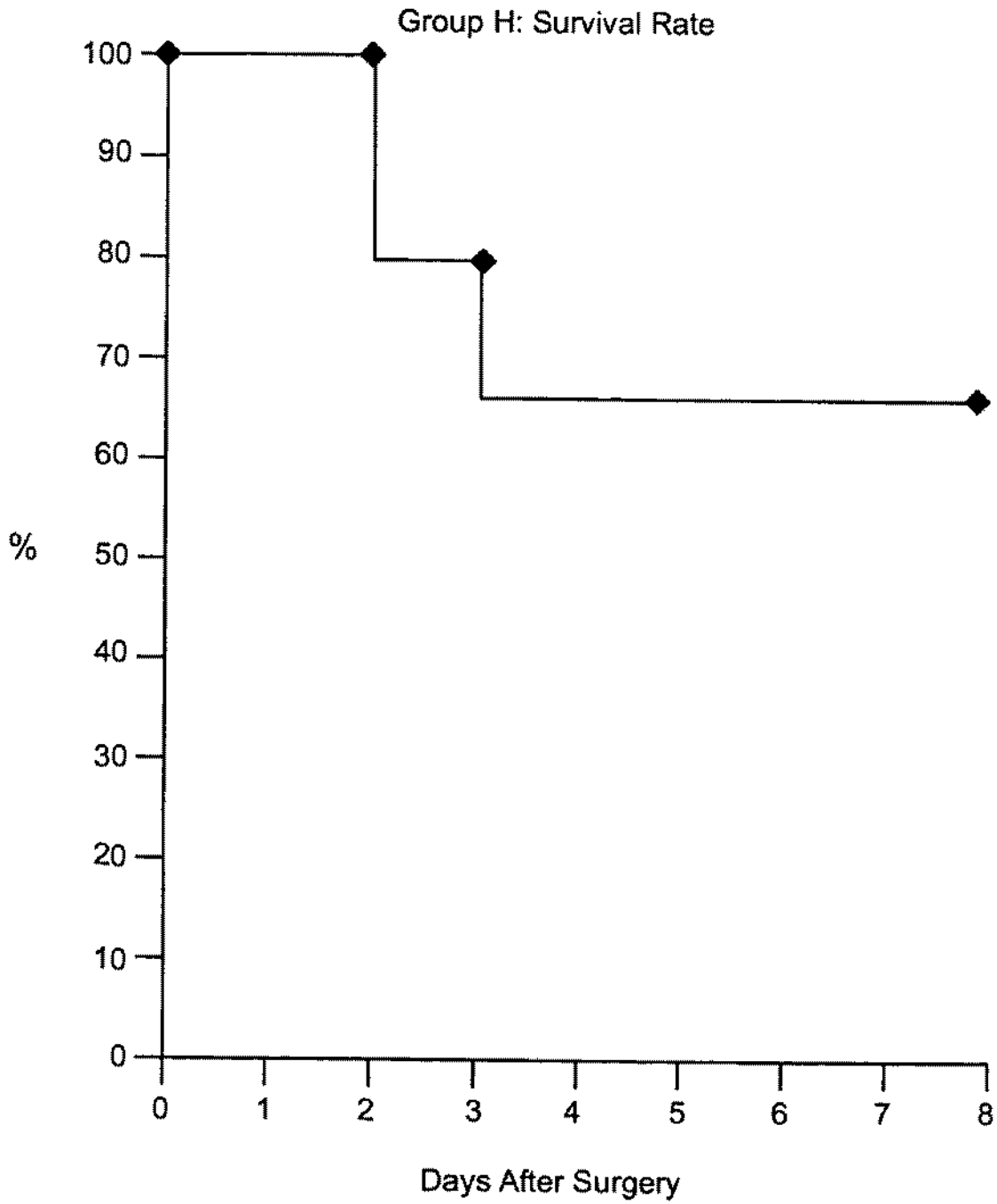
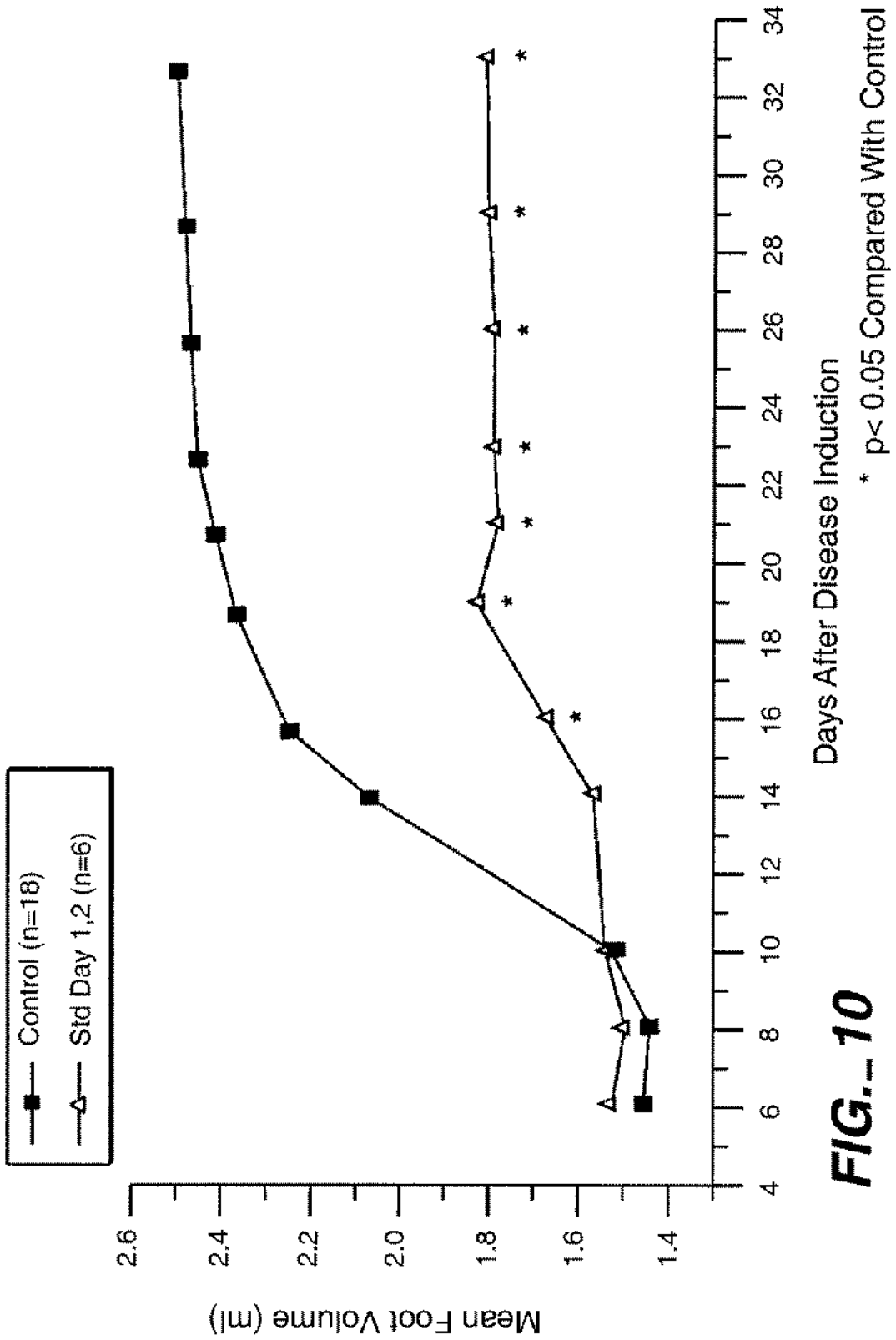


FIG.-7





**FIG.\_9**



**FIG. 10**

## METHOD FOR TREATING MAMMALS WITH MODIFIED MAMMALIAN BLOOD

This application is a continuation of U. S. patent application Ser. No. 09/564,853 filed on May 5, 2000 now U. S. Pat. No. 6,986,888, which claims priority to Canadian Patent Application No. 2,2171,190, filed on May 6, 1999, all of which applications are incorporated herein by reference in their entireties.

### FIELD OF THE INVENTION

This invention relates to the field of medicine and medical treatments. In particular, the invention relates to improved methods for treating the mammalian body, including the human body, by administration thereto of modified mammalian blood.

### BACKGROUND OF THE INVENTION

Mammalian blood modified by exposure to one or more certain stressors has been found useful for the treatment and prevention of a wide variety of pathological conditions. The stressors to which the blood is exposed are selected from one or more of an oxidative environment, a temperature stressor and ultraviolet (UV) light. The following is a brief discussion of the prior art relating to uses of mammalian blood which has been modified by one or more of the above-mentioned stressors.

U.S. Pat. No. 4,968,483 to Mueller et al. describes an apparatus for oxygenating blood by treating an aliquot of a patient's blood extracorporeally, with an oxygen/ozone mixture and UV light, at a controlled temperature. The apparatus taught by Mueller is proposed for use in hematological oxidation therapy.

U.S. Pat. No. 5,591,457 to Bolton discloses a method of inhibiting the aggregation of blood platelets in a human, a method of stimulating the immune system and a method of treating peripheral vascular diseases such as Raynaud's disease, by extracting an aliquot of blood from a patient, subjecting it to an ozone/oxygen gas mixture and UV light at a temperature in the range of about 37 to 43° C., and then re-injecting the treated blood in the human patient.

U.S. Pat. No. 5,834,030 to Bolton describes a similar process for increasing the content of nitric oxide in the blood of mammalian subject, potentially useful in treating conditions such as high blood pressure in mammalian subjects. Example 5 of this patent discloses a course of treatment comprising ten injections of modified mammalian blood administered over a period of 2 to 4 weeks.

International Publication No. WO 98/07436 describes an autoimmune vaccine for administration to human patients to alleviate the symptoms of autoimmune diseases such as rheumatoid arthritis. The vaccine comprises an aliquot of the subject's blood which has been subjected extracorporeally to an oxidizing environment, UV light and elevated temperature. This application discloses a course of treatment comprising from 30 to 60 injections of modified mammalian blood.

International Publication No. WO 96/34613 relates to treatment of vascular disorders associated with deficient endothelial function, in a mammalian subject, by administration to the patient of an aliquot of blood which has been modified by having been subjected to at least one stressor selected from elevated temperature in the range of 37° to 55° C., UV light and an oxidative environment. This application discloses a number of different treatment methods. For

example, Example 1 discloses ten injections of modified mammalian blood administered over a period of 2 weeks; Example 2 discloses ten injections over a period of 2 to 4 weeks; Example 3 discloses a treatment schedule comprising two courses of treatment, the first course comprising ten injections over a period of 2 to 4 weeks and the second course comprising five injections; and Example 5 discloses administration of five injections at 2 to 3 day intervals.

U.S. patent application Ser. No. 09/190,236, filed Nov. 13, 1998, describes a method for lowering levels of lipids in mammals by injecting a mammalian subject with an aliquot of mammalian blood which has been treated extracorporeally by one or more stressors selected from heat, UV light and oxidative environments. This application describes a study in which animals were subjected to a course of treatment comprising a total of 10 injections over 12 days, with two sets of 5 daily injections being separated by a rest period of two days.

U.S. patent application Ser. No. 09/151,653, filed Nov. 9, 1998, discloses a method for treatment of stress and preconditioning against stress by injecting a mammalian subject with an aliquot of mammalian blood having been subjected extracorporeally to at least one stressor selected from an oxidative environment, UV light and elevated temperature up to about 45° C. This application discloses various treatment methods. Examples 1 and 3 disclose a single course of treatment comprising ten injections administered over a period of 10 days; and Examples 4 and 6 to 8 disclose a treatment method comprising two courses of treatment, each comprising ten injections administered over a period of 10 days, separated by a rest period of about three weeks.

Although the treatments described above have been shown to be useful in the treatment and prevention of a wide range of pathological conditions, there is a desire to develop a treatment schedule which is less costly to administer and more convenient to patients, and which either improves or at least does not reduce the effectiveness of the treatment.

### SUMMARY OF THE INVENTION

The present invention provides a novel method of treating a mammalian subject with modified mammalian blood which provides advantages over previously known methods of treatment, which have typically required subjects to be treated with a relatively large number of injections of modified blood.

The present invention is based upon the discovery that an effective treatment may be provided in which the number of aliquots of modified blood administered to the mammalian subject is substantially reduced from that disclosed in the prior art, while the efficacy of the treatment is significantly enhanced.

Accordingly, in one aspect, the present invention provides a method of treatment or prophylaxis of a condition in a mammalian subject in which modified mammalian blood is administered to said subject, said blood being modified extracorporeally by exposure to at least one stressor selected from the group consisting of an oxidative environment, an electromagnetic emission and a temperature above or below body temperature, said method comprising: administering to said subject from two to four aliquots of said modified mammalian blood, with the administration of any pair of consecutive aliquots either being on consecutive days or being separated by a rest period of 1 to 21 days on which no aliquots are administered to the subject; the rest period preferably being from about 3 to about 15 days.

The modified aliquot of blood is preferably prepared by exposing it to one or more stressors selected from an oxidative stressor, a temperature stressor and an electromagnetic emission, alone or in combinations of two or three of such stressors, applied simultaneously or sequentially.

#### BRIEF DESCRIPTION OF THE DRAWINGS

The invention will now be more fully described, by way of example only, with reference to the accompanying drawings.

FIG. 1 is a graph showing the survival rate of rats indicated as the number of days following surgery to induce ischemia/reperfusion injury versus percentage of survival rate of the rats, where the rats received injection of modified blood on days 1 and 21.

FIG. 2 is a graph showing the urine volume (ml) in rats 24 hours after renal ischemic/reperfusion injury was surgically induced, where the rats received injection of modified blood on days 1 and 21.

FIG. 3 is a graph showing the survival rate of rats indicated as the number of days following surgery to induce ischemia/reperfusion injury versus percentage survival rate of the rats, where the rats received injection of modified blood on day 1, followed by a five day rest period, and a second injection of modified blood on day 7.

FIG. 4 is a graph showing the urine volume (ml) in rats 24 hours after renal ischemia/reperfusion injury was surgically induced, where the rats received injection of modified blood on day 1, followed by a five day rest period, and a second injection of modified blood on day 7.

FIG. 5 is a graph showing the survival rate of rats indicated as the number of days following surgery to induce ischemia/reperfusion injury versus percentage survival rate of the rats, where the rats received injection of modified blood on day 1 and day 2, followed by a rest period of 11 days, and a third injection of modified blood on day 14.

FIG. 6 is a graph showing the urine volume (ml) in rats 24 hours after renal ischemic/reperfusion injury was surgically induced, where the rats received injection of modified blood on day 1 and day 2, followed by a rest period of 11 days, and a third injection of modified blood on day 14.

FIG. 7 is a graph showing the survival rate of rats indicated as the number of days following surgery to induce ischemia/reperfusion injury versus Percentage survival rate of the rats, where the rats received an injection of saline on days 1 and 21.

FIG. 8 is a graph showing the urine volume (ml) in rats 24 hours after renal ischemia/reperfusion injury was surgically induced, where the rats received an injection of saline on days 1 and 21.

FIG. 9 is a graph showing the survival rate of rats indicated as the number of days following surgery to induce ischemia/reperfusion injury versus percentage survival rate of the rats, where the rats received injection of treated blood on day 1, followed by a rest period of 12 days, and a second injection of treated blood on day 14.

FIG. 10 is a graph showing the number of days following the induction of arthritis and mean foot volume in the control group (saline) in the test group.

#### DETAILED DESCRIPTION OF PREFERRED EMBODIMENTS

According to a preferred process of the present invention, an aliquot of blood is extracted from a mammalian subject, preferably a human, and the aliquot of blood is treated ex

vivo with certain stressors, described in more detail below. The terms "aliquot", "aliquot of blood" or similar terms used herein include whole blood, separated cellular fractions of the blood including platelets, separated noncellular fractions of the blood including plasma, plasma components, and combinations thereof. The effect of the stressors is to modify the blood, and/or the cellular or non-cellular fractions thereof, contained in the aliquot. The modified aliquot is then re-introduced into the subject's body by any suitable method, most preferably intramuscular injection, but also including subcutaneous injection, intraperitoneal injection, intra-arterial injection, intravenous injection and oral, nasal or rectal administration.

The stressors to which the aliquot of blood is subjected ex vivo according to the method of the present invention are selected from temperature stress (blood temperature above or below body temperature), an oxidative environment and an electromagnetic emission, individually or in any combination, simultaneously or sequentially. Suitably, in human patients, the aliquot has a sufficient volume that, when re-introduced into the patient's body, has the desired effect. Preferably, the volume of the aliquot is up to about 400 ml, preferably from about 0.1 to about 100 ml, more preferably from about 5 to about 15 ml, even more preferably from about 8 to about 12 ml, and most preferably about 10 ml.

It is preferred, according to the invention, to apply all three of the aforementioned stressors simultaneously to the aliquot under treatment, in order to ensure the appropriate modification to the blood. It may also be preferred in some embodiments of the invention to apply any two of the above stressors, for example to apply temperature stress and oxidative stress, temperature stress and an electromagnetic emission, or an electromagnetic emission and oxidative stress. Care must be taken to utilize an appropriate level of the stressors to thereby effectively modify the blood to achieve the desired effect.

The temperature stressor warms the aliquot being treated to a temperature above normal body temperature or cools the aliquot below normal body temperature. The temperature is selected so that the temperature stressor does not cause excessive hemolysis in the blood contained in the aliquot and so that, when the treated aliquot is injected into a subject, the desired effect will be achieved. Preferably, the temperature stressor is applied so that the temperature of all or a part of the aliquot is up to about 55° C., and more preferably in the range of from about -5° C. to about 55° C.

In some preferred embodiments of the invention, the temperature of the aliquot is raised above normal body temperature, such that the mean temperature of the aliquot does not exceed a temperature of about 55° C., more preferably from about 40° C. to about 50° C., even more preferably from about 40° C. to about 44° C., and most preferably about 42.5±1° C.

In other preferred embodiments, the aliquot is cooled below normal body temperature such that the mean temperature of the aliquot is within the range of from about -5° C. to about 36.5° C., even more preferably from about 10° C. to about 30° C., and even more preferably from about 15° C. to about 25° C.

The oxidative environment stressor can be the application to the aliquot of solid, liquid or gaseous oxidizing agents. Preferably, it involves exposing the aliquot to a mixture of medical grade oxygen and ozone gas, most preferably by bubbling through the aliquot, at the aforementioned temperature range, a stream of medical grade oxygen gas having ozone as a minor component therein. The ozone content of the gas stream and the flow rate of the gas stream are

preferably selected such that the amount of ozone introduced to the blood aliquot, either on its own or in combination with other stressors, does not give rise to excessive levels of cell damage such that the treatment is rendered ineffective. Suitably, the gas stream has an ozone content of up to about 300  $\mu\text{g}/\text{ml}$ , preferably up to about 100  $\mu\text{g}/\text{ml}$ , more preferably about 30  $\mu\text{g}/\text{ml}$ , even more preferably up to about 20  $\mu\text{g}/\text{ml}$ , particularly preferably from about 10  $\mu\text{g}/\text{ml}$  to about 20  $\mu\text{g}/\text{ml}$ , and most preferably about 14.5 $\pm$ 1.0  $\mu\text{g}/\text{ml}$ . The gas stream is suitably supplied to the aliquot at a rate of up to about 2.0 liters/min, preferably up to about 0.5 liters/min, more preferably up to about 0.4 liters/min, even more preferably up to about 0.33 liters/min, and most preferably about 0.24 $\pm$ 0.024 liters/min. The lower limit of the flow rate of the gas stream is preferably not lower than 0.01 liters/min, more preferably not lower than 0.1 liters/min, and even more preferably not lower than 0.2 liters/min.

The electromagnetic emission stressor is suitably applied by irradiating the aliquot under treatment from a source of an electromagnetic emission while the aliquot is maintained at the aforementioned temperature and/or while the oxygen/ozone gaseous mixture is being bubbled through the aliquot. Preferred electromagnetic emissions are selected from photonic radiation, more preferably ultraviolet (UV), visible and infrared light, and even more preferably UV light. The most preferred sources of UV light are UV lamps emitting primarily UV-C band wavelengths, i.e. wavelengths shorter than about 280 nm. Such lamps may also emit amounts of visible and infrared light. Sources of UV light corresponding to standard UV-A (wavelengths from about 315 to about 400 nm) and LW-B (wavelengths from about 280 to about 315) can also be used. For example, an appropriate dosage of such UV light, applied simultaneously with one or both of the aforementioned temperature and oxidative environment stressors, can be obtained from up to eight lamps arranged to surround the sample container holding the aliquot, operated at an intensity to deliver a total LW light energy at the surface of the blood of from about 0.025 to about 10 joules/cm<sup>2</sup>, preferably from about 0.1 to about 3.0 joules/cm<sup>2</sup>. Preferably, four such lamps are used.

The time for which the aliquot is subjected to the stressors is normally within the time range of up to about 60 minutes. The time depends to some extent upon the chosen intensity of the electromagnetic emission, the temperature, the concentration of the oxidizing agent and the rate at which it is supplied to the aliquot. Some experimentation to establish optimum times may be necessary on the part of the operator, once the other stressor levels have been set. Under most stressor conditions, preferred times will be in the approximate range of from about 2 to about 5 minutes, more preferably about 3 minutes. The starting blood temperature, and the rate at which it can be warmed or cooled to a predetermined temperature, tends to vary from subject to subject. Such a treatment provides a modified blood aliquot which is ready for injection into the subject.

In one preferred embodiment of the present invention, the aliquot of blood is stressed by being simultaneously subjected to all three of the above stressors using an apparatus of the type described in aforementioned U.S. Pat. No. 4,968,483, issued on Nov. 6, 1990 to Mueller. The aliquot is placed in a suitable, sterile, UV light-transmissive container, which is lifted into the machine. The UV lamps are switched on for a fixed period before the gas flow is applied to the aliquot providing the oxidative stress, to allow the output of the UV lamps to stabilize. The UV lamps are typically on while the temperature of the aliquot is adjusted to the predetermined value, e.g. 42.5 $\pm$ 1° C. Then the oxygen/

ozone gas mixture, of known composition and controlled flow rate, is applied to the aliquot, for the predetermined duration of up to about 60 minutes, preferably 2 to 5 minutes and most preferably about 3 minutes as discussed above, so that the aliquot experiences all three stressors simultaneously. In this way, blood is appropriately modified according to the present invention to achieve the desired effects.

In the preferred method of the invention, each course of treatment comprises the administration to a mammalian subject of from two to four aliquots of mammalian blood which has been modified as discussed above.

For optimum effectiveness of the treatment, it is preferred that no more than one aliquot of modified blood be administered to the subject per day. In some preferred embodiments of the invention, at least one rest period is provided during the course of treatment. As used herein, the term "rest period" is defined as the number of days between consecutive aliquots on which no aliquots of modified blood are administered to the subject. The maximum rest period between any two consecutive aliquots during the course of treatment is preferably no greater than about 21 days, and is more preferably from about 3 to about 15 days.

In some preferred embodiments, aliquots of modified blood are administered to the subject on consecutive days, i.e. without an intervening rest period. Some preferred embodiments of the invention (comprising administration of 3 or 4 aliquots) include administration of a pair of aliquots on consecutive days and also provide for a rest period between a pair of consecutive aliquots.

More preferably, a course of treatment comprises administration of two or three aliquots to the subject, the course of treatment optionally including at least one rest period, with the longer (in the case of three aliquots) or the only (in the case of two aliquots) rest period between consecutively administered aliquots being from about 5 to 15 days.

Where the course of treatment comprises the administration of two aliquots to the subject, it is most preferred that the aliquots be administered on consecutive days without an intervening rest period.

Where the course of treatment comprises the administration of three aliquots to the subject, it may be preferred to provide two rest periods, including a longer rest period having a length of 9 to 13 days, more preferably about 10 to 12 days, and most preferably about 11 days; and a shorter rest period of 1 to 3 days.

However, where the course of treatment comprises three injections, it is most preferred to administer two of the three aliquots on consecutive days, and also to provide a rest period between two aliquots having a length of 9 to 13 days, more preferably about 10 to 12 days, and most preferably about 11 days. In a particularly preferred example, the first and second aliquots are administered on consecutive days without an intervening rest period, and the second and third aliquots are separated by a rest period of 11 days.

Although it may be sufficient to administer only one course of treatment as described above to the subject, it may be preferred in some circumstances to administer two or more courses of treatment, or to follow the above-described course of treatment by periodic "booster" treatments, if necessary, to maintain the desired effects of the present invention. In particular, it may be preferred to administer booster treatments or to administer a second course of treatments to the subject following a time period of several weeks or months. For example, it may be preferred to provide a time period of from about 1 to about 4 months

between consecutive courses of treatment, with 6 weeks being particularly preferred in some embodiments of the invention.

In one preferred embodiment, it is preferred to administer a first course of therapy comprising three injections, with the first and second aliquots being administered on consecutive days without an intervening rest period, and the second and third aliquots are separated by a rest period of 11 days. Following a period of six weeks from the end of the first course of therapy, an identical second course of therapy is administered to the subject.

The invention is further illustrated and described with reference to the following specific examples, comprising animal studies conducted in an approved manner.

In following Examples 1 to 5, the beneficial effects of the present invention are demonstrated in vivo by clinical experiments on juvenile and adult rats, specifically rats of an inbred strain of genetically hypertensive rats (SHR's). These genetically hypertensive rats are the most widely used animal model for hypertension research, and are well known and readily available to researchers in this field. SHR's have several genetic defects, one of the most important being failure to produce appropriate amounts of heat shock proteins when subjected to stress. SHR's develop hypertension rapidly and exhibit exaggerated increases in heart rate, blood pressure and body temperature in response to stress. They represent a model of hypersensitivity to stress. The results obtained using SHR's provide reliable indications of potential results obtainable with human patients.

#### EXAMPLE 1

Blood from sacrificed SHR's of the same strain as the test animals was collected, treated with sodium citrate anticoagulant and cooled. A portion of the blood was then placed in a sterile container, and subjected simultaneously to UV light, an ozone/oxygen gas oxidative environment and elevated temperature stressors, in an apparatus as generally described in the above-mentioned Mueller patent. More specifically, the blood sample in the sterile, UV-transparent container was heated using infrared lamps to 42.5° C., and while maintained at that temperature, was subjected to UV light emitting UV-C band wavelengths under the preferred conditions previously described. Simultaneously, a gaseous mixture of medical grade oxygen and ozone, the mixture having an ozone content of 13.5 to 15.5 µg/ml, was bubbled through the blood sample at a flow rate of about 240 ml/min. The time of simultaneous UV exposure and gas mixture feed was 3 minutes.

To provide a control, a sterile aqueous physiological saline solution was also prepared.

A total of 60 seven week old SHR's were selected and divided into five groups, Groups A, E, F, G and H, each containing 12 animals. For a period of 10 days (at 7 to 9 weeks of age), each animal of Group A received a daily intraglutal injection of 150 µl of the UV, heat and ozone treated blood, followed by a rest period of 21 days. After the rest period, the animals were subjected to a second series of 10 daily injections of the modified blood, each injection having a volume of 150 µl.

One day following the second course of injections, the rats of Group A were anesthetized under light gas anesthesia, and the right kidney of each animal was removed through a back incision. An occlusive clip was placed on the remaining renal artery and vein to expose the left kidney to transient ischemia, for 60 minutes. Following the exposure to ischemia, the skin was definitively closed. The animals were

then followed with respect to the degree of injury resulting from the ischemia and/or the subsequent reperfusion by determining survival rates and by observing the urine output of the animals, which is a measure of renal function.

The survival rate was monitored by daily count of survivors, and is graphically represented in FIG. 1. After eight days, 58% (7 animals) of the sub-group A animals which had received the treated blood injections were surviving. FIG. 2 illustrates that 5 animals were anuric, meaning that they produced less than 2 ml of urine in the 24 hour period following surgery.

#### EXAMPLE 2

The twelve animals of Group E were treated as discussed above in Example 1, with the exception that the course of therapy comprised a single course of treatment, each comprising two injections separated by a 5 day rest period (i.e. injection on day 1, followed by a five day rest period, followed by an injection on day 7).

Ischemia was induced one day following the final injection as described in Example 1 in the Group E animals, and the results are shown in FIGS. 3 and 4. Specifically, FIG. 3 shows that after 8 days following surgery, 67% (8 animals) of the Group E animals were surviving, and FIG. 4 illustrates that only 4 of the animals of Group E were anuric.

#### EXAMPLE 3

The Group F animals were treated as set out in Example 1, with the exception that the course of treatment comprised a total of three injections, with the first two injections being administered on consecutive days, with 11 days rest separating the second and third injections (i.e. injections on days 1 and 2, 11 day rest period, injection on day 14).

Ischemia was induced one day following the final injection in the Group F animals as described above in Example 1, with the results being shown in FIGS. 5 and 6. FIG. 5 illustrates a significant increase in survival rate, with 100% of the animals surviving eight days after the surgery. In addition, only 3 of the animals of Group F were shown to be anuric in the 24 hour period following surgery.

#### EXAMPLE 4

The animals of Group G received injections of physiological saline in place of modified blood, following an injection schedule identical to that in Example 1. Ischemia was induced one day following the final injection as described above in Example 1, and the results are shown in FIGS. 7 and 8. Only 42% (5 animals) of the Group G animals were surviving 8 days after the surgery, and 7 of the animals were shown to be anuric in the 24 hour period following surgery.

#### EXAMPLE 5

The animals in Group H were treated with a single course of treatment, comprising two injections separated by a 12 day rest period (i.e. injection on day 1, 12 day rest period, injection on day 14). The results of the ischemic stress on the animals of Group H are illustrated in FIG. 9, which illustrates that 67% (8 animals) in Group H were surviving eight days after the surgery. Also, 3 of the animals in Group H were anuric in the 24 hour period following surgery.

The results of the above animal studies are tabulated below.

TABLE I

Group	# of Courses	# of Injections	Rest Period (Days)	Survival Rate After 8 Days	# of Amuric Animals
A	2	10 + 10	21	58%	5
E	1	1 + 1	5	67%	4
F	1	2 + 1	11	100%	3
G*	2	10 + 10	21	42%	7
H	1	1 + 1	12	67%	3

\*Saline Control

The above results demonstrate that the method of the present invention protects the kidney from injury resulting from ischemia and/or reperfusion, as measured by survival rate and urine flow in the 24 hours following surgery in the SHR. This indicates use of the procedure in protecting other body organs from ischemia/reperfusion injury, including the heart, the liver, the brain, the spinal cord and other vital organs, and indicates practical application of the procedure on patients scheduled to undergo surgical procedures involving ischemia/reperfusion of a body organ, such as surgical repair, removal or transplantation of a body organ.

In particular, ischemic acute renal failure is an important clinical problem with high morbidity and high mortality. The process of the present invention presents a novel approach to combatting this disorder. It can be adopted prior to kidney transplantation, on either or both the donor or recipient. It can be adopted prior to kidney revascularization. It can be adopted prior to invasive evaluation in high risk subjects, e.g. angiography in diabetics. It can be adopted prior to abdominal aortic surgery such as aortic aneurism repair and renal bench surgery (i.e. where the kidney is temporarily removed and operated on ex vivo, and then re-implanted).

As regards its use in connection with procedures involving the heart, the procedure of the invention can be conducted prior to coronary angioplasty, and bypass, or prior to transplantation, as in the case of the kidney. It is indicated for use with patients about to undergo open heart surgery with cardio-pulmonary bypass for coronary artery bypass grafting, valve replacement or surgical repair of congenital or acquired cardiac structural abnormalities. In the case of the brain or other vital organs and tissues including the intestines, the kidneys and limbs, the procedure of the invention can be used prior to angioplasty or endarterectomy, in high risk subjects.

In connection with body organs destined for transplantation, treatment of the donor body by the process of the present invention serves to protect body organs against damage resulting from the inevitable ischemia which the organ will suffer on removal from the donor body, transportation and subsequent surgical introduction into the recipient body. The treatment according to the invention extends the useful life of the transplant organ between its removal from the donor body and its surgical introduction into the recipient body, thereby reducing losses of viable transplant organs due to transportation delays.

The use of the process of the present invention prior to general anaesthesia in connection with major surgery can be viewed as general pre-conditioning of the body, to better withstand ischemia-reperfusion injuries to which the major organs will later be subjected. It is indicated for use prior to conducting major surgical procedures involving general anaesthesia in patients known to have or likely to have a

significant degree of underlying atherosclerosis in the arteries supplying the brain, heart, liver, intestine, spinal cord, kidneys or limbs, the atherosclerosis rendering them more susceptible to a thrombo-ischemic event in the operative or post-operative period. In addition, it is known that repetitive mild ischemic (anginal) episodes can render tissues and organs less susceptible to stress-induced damage, by ischemic preconditioning, although application of ischemic preconditioning by current methods is largely impractical. The process of the present invention can take the place of ischemic preconditioning, ischemia being a species of physical stress. Accordingly, the process of the present invention offers potential for treatment of unstable angina and decrease of infarct size, a treatment not effectively addressed by available therapies.

A further, specific clinical application of the process of the invention is in treatment of patients suffering from transient ischemic attacks (TIA's, pre-strokes), which are due to temporary obstruction of blood flow to certain areas of the brain. They commonly indicate the likelihood of suffering a major stroke in the near future. Subjecting of such patients to treatment according to the process of the invention, at the onset of TIA's, will precondition the brain to avoid or at least to lessen the severity of the effects of the forthcoming major stroke.

Similar general pre-conditioning of the body by the process of the invention is also indicated for use in alleviating the effects of subsequently encountered shock, leading to under-perfusion of vital organs and tissues through failure of cardiac action due to loss of blood or other body fluids, excessive dilation of blood vessels and excessively low blood pressure. Examples include major blood loss, trauma, sepsis and cardiogenic shock. Individuals likely to be exposed to such hazards, including patients awaiting surgery, rescue and relief crews for natural disasters, would be beneficiaries of the process of the invention.

It now appears that common physiological events underlie all stress responses, including responses to ischemic stresses. These physiological events include the induction and upregulation or synthesis, in all body cells, of a group of specialized intracellular proteins known as heat stress proteins or heat shock proteins (HSP's). These HSP's function to protect the cells from potential damage caused by whatever form of stress is being applied. Therefore, it is expected that the method of the present invention is of general application and will be effective to provide a subject with resistance to a wide variety of different types of stresses, whether evident at the time the treatment is administered, or whether subsequently encountered. For example, psychological stresses induced by restraint, confinement, sudden exposure to danger, shock and the like translate into physical stresses affecting one or more organs of the body. Similarly, physical stress such as exposure to heat or cold, over-exertion and the like, result in abnormal functioning of body organs.

A subject who has undergone a treatment according to the method of the present invention will exhibit notably reduced adverse reactions to subsequently encountered stress, such as a notably reduced rise in body temperature, a reduced increase in heart rate and/or a reduced increase in diastolic blood pressure in response to stress, as compared to a similar but untreated subject.

In addition, it is expected that the improved results obtained by using the process of the invention would also be applicable to other conditions which may be treated by administration to a subject of modified mammalian blood, such as those discussed above with reference to the prior art.

Specific examples of such conditions are diseases of the circulatory system caused by atherosclerosis, for example coronary artery disease, cerebrovascular disease, peripheral vascular disease and diseases of other vascular systems; vasospastic disorders including primary and secondary Raynaud's disease, cardiac syndrome X (microvascular angina), migraine headache, cluster headache, hypertension, pre-eclampsia, and thrombotic disorders related to increased platelet aggregation and/or coagulation abnormalities and/or related endothelial dysfunction; immune system disorders such as rheumatoid arthritis, asthma, graft-versus-host disease, diabetes mellitus, organ rejection, miscarriage, systemic lupus erythematosus, atopic allergy, multiple sclerosis, allergic dermatitis, inflammatory bowel disease and psoriasis.

#### EXAMPLE 6

##### Model:

The purpose of the experiment is to determine the effects of treatment according to the present invention on the development of atherosclerosis in the LDL receptor (LDL-R) deficient mouse model, a widely used transgenic atherosclerosis model created by targeted disruption of the LDL receptor. This animal model is analogous to familial hypercholesterolemia, an inherited condition in which a mutation results in complete lack of functional LDL-R. In the human disease, homozygous individuals demonstrate a marked increase in serum cholesterol and develop severe premature atherosclerosis, often succumbing to this disease at an early age. In patients with this disease, currently used lipid lowering agents do not have a significant effect in terms of lowering cholesterol levels.

The LDL-R deficient mouse model shows intolerance to cholesterol feeding and develops widespread atherosclerotic changes which progress to mature fibrous lesions morphologically indistinguishable from established human atherosclerosis. Apart from the defined genetic abnormality causing predisposition to atherosclerosis, this model has the advantage of rapid development of widespread atherosclerosis within 6 to 8 weeks following institution of cholesterol feeding.

##### Protocol:

LDL-R deficient mice were purchased from Jackson Laboratories. The mice were entered into the study at 22 weeks of age. The mice were maintained on a 12 hour dark/12 hour light cycle with free access to food and water, and were fed a specified diet as follows.

Group A (control)—fed a normal diet;

Group B1—fed a high cholesterol diet as described below for 8 weeks;

Group B2—fed a high cholesterol diet as described below for 12 weeks;

Group C1—fed a high cholesterol diet as described below for 8 weeks, and treated by the preferred method of the present invention as described below at 4 weeks of dietary intervention; and

Group C2—fed a high cholesterol diet as described below for 12 weeks, and treated by the preferred method of the present invention as described below at 8 weeks of dietary intervention.

The high cholesterol group were fed a diet containing 1.25% cholesterol, 7.5% cocoa butter, 7.5% casein, and

0.5% sodium cholate. To ensure proper food intake, food consumption and animal weight were monitored on a weekly basis. In previous experiments, it was demonstrated that 8 weeks of feeding with the high cholesterol diet results in substantial atherosclerosis development, particularly in the aortic arch and the descending thoracic aorta.

##### Treatment:

Animals fed the high cholesterol diet were selected at random to undergo a course of treatment by the preferred method of the invention. The treatments began four or eight weeks after initiation of the study, with each of the animals on the high cholesterol diet receiving a total of 3 treatments (injections on days 1, 2 and 14 of the treatment). Each individual injection administered to the animals treated by the method of the present invention consisted of the collection of 10 ml of blood from genetically compatible donor animals fed on a normal diet, the blood being collected into sodium citrate anticoagulant. In order to collect each 10 ml aliquot of blood, about 1 ml of blood was extracted from each of 10 animals. The blood was extracted by cardiac puncture, with the animals being under full xylazine/ketamine anesthesia during the blood extraction procedure, and being given T-61 immediately following extraction. The blood aliquot was transferred to a sterile, disposable, low-density polyethylene vessel for ex vivo treatment, and was then treated simultaneously with a gaseous oxygen/ozone mixture and ultraviolet light at elevated temperature using an apparatus as generally described in aforementioned U.S. Pat. No. 4,968,483 to Mueller et al.

The constitution of the gas mixture was  $14.5 \pm 1.0$   $\mu$ g ozone/ml, with the remainder of the mixture comprising medical grade oxygen. The gas mixture was bubbled through the aliquot at a rate of  $240 \pm 24$  ml/min for a period of 3 minutes. The temperature of the aliquot was held steady at  $42.5 \pm 1.0^\circ$  C. The UV light was within the UV-C band, and included a wavelength of 253.7 nm.

After treatment by the preferred method of the present invention, 30  $\mu$ l of the treated blood was re-injected intramuscularly into each animal undergoing treatment according to the present invention. As discussed above, 3 treatments were administered to each animal over a 14 day period, with injections being administered on days 1, 2 and 14.

In the sham treatments, 30  $\mu$ l of untreated blood was injected intramuscularly into each of the remaining five animals on the high cholesterol diet.

##### Assessment of Atherosclerosis:

After 8 or 12 weeks, the animals were anesthetized with zylaxine/ketamine and the heart was exposed. After nicking the vena cava to obtain blood samples, the animals were perfused via ventricular puncture, first with PBS to flush out the blood and then with 10% neutral buffered formalin for 3 minutes to fix the aorta. The thoracic aorta was dissected away from the thorax en bloc and stored in 10% formalin at  $4^\circ$  C. Pressure-fixed (10% formalin) aortae were removed en bloc and opened to allow a longitudinal lill length inversion. The aortae were then mounted internally exposed on glass slides and stained with oil red O. The bright red staining (indicating lipid deposition) was then quantified using a computer assisted morphometric system, and expressed as a percentage of total aortic intimal surface.

##### Statistical Analysis:

Continuous variables are reported as mean  $\pm$  SD. Differences in atherosclerotic lesion area among groups were tested using the one-way ANOVA test in conjunction with the Bonferroni correction.



## Results:

As demonstrated by measurement of atherosclerotic area, the animals of group B (high cholesterol diet alone) exhibited substantial aortic lipid deposition, with group B1 animals having atherosclerosis ratios (AA/TA) of  $0.16 \pm 0.1$  at eight weeks and group B2 animals having ratios of  $0.17 \pm 0.1$  at 12 weeks of dietary intervention. In contrast, the animals of group C (high cholesterol diet with treatment according to the invention) exhibited profoundly reduced lipid deposition, with group C1 animals having ratios of  $0.04 \pm 0.02$  ( $p < 0.05$ ) at eight weeks of dietary intervention, and group C2 animals having ratios of  $0.04 \pm 0.02$  ( $p < 0.01$ ) at twelve weeks of dietary intervention.

The animals of group C also exhibited a marked reduction in xanthelasma and limb swelling as compared to animals of group B.

As shown in Example 6, the treatment according to the present invention substantially inhibited the development of atherosclerosis in a mouse model of familial hypercholesterolemia. These improvements in cardiovascular health were accompanied by improvements in the animals' general overall appearance and appetite.

## EXAMPLE 7

In this example, LDL-R deficient mice were fed a high cholesterol diet as in Example 6 for a period of 12 weeks and divided into two treatment groups, Group I and Group II. All animals of both groups received a first course of treatment comprising injections on days 1, 2 and 14 as described above in Example 6. In addition, the animals of Group II received a second, identical course of treatment 6 weeks after the end of the first course of treatment.

All animals were sacrificed 24 weeks after initiation of the high cholesterol diet. Calculation of percent plaque area by en face examination of oil red O stained aortas revealed a 38% reduction in plaque-area in Group II animals ( $0.32 \pm 0.03\%$  for sham versus  $0.20 \pm 0.03\%$  for treated,  $p = 0.016$ ) but no reduction in plaque area in the Group I animals.

The above example indicates that in some embodiments of the invention it may be preferred to administer two or more courses of therapy at spaced intervals.

## EXAMPLE 8

This example demonstrates the beneficial effects of the present invention in vivo clinical experiments on rats, specifically male Lewis rats in which rheumatoid-like arthritis has been induced. An animal model used for studying rheumatoid arthritis is adjuvant-induced arthritis in a rat model (see, for example, Pearson, C., 1956, "Development of Arthritis, periardritis and periostitis in rats given adjuvant", *Proc. Soc. Exp. Biol. Med.*, 91:95). According to this model, arthritis is induced in rats by injecting them with adjuvant containing *Mycobacterium butyricum*.

Male Lewis rats, 4 to 5 weeks of age, 100 to 120 g, were obtained from Charles River Laboratories, quarantined one week and entered into the study. An adjuvant mixture was prepared for induction of arthritis by suspending 50 mg *M. butyricum* (Difco Laboratories, Inc., Detroit Mich.) in 5 ml light white paraffin oil—m3516 (Sigma Chemical Co., St. Louis, Mo.) and thoroughly mixed using a homogenizer.

Aliquots of the mixture sufficient to supply 0.15 mg *M. butyricum* were injected into each animal subcutaneously, at the base of the tail. Symptoms of arthritis appeared about 12 days after induction, in each animal, as evidenced by limb swelling.

Blood was collected from donor animals, by cardiac puncture. 10 ml of citrated donor blood was transferred to a sterile, low density polyethylene vessel for ex vivo treatment with stressors according to the invention. Using an apparatus as described in the above-mentioned Mueller patent (more specifically, a VasoCare™ V7000 apparatus), the blood was heated to  $42.5 \pm 1^\circ \text{C}$ . and at that temperature irradiated with ultraviolet light, principally at a wavelength of 254 nm, while a gas mixture of medical grade oxygen containing  $14.5 \pm 1.0 \mu\text{g/ml}$  of ozone was bubbled through the blood at a flow rate of  $240 \pm 24 \text{ ml/min}$ .

Six animals were given a course of 2 injections of 0.2 ml aliquots of the treated blood, on days 1 and 2 after disease induction. Eighteen animals were injected with untreated blood or saline as controls. Hind paw volumes and clinical scores of the animals were measured every 2 to 3 days for 5 weeks after disease induction. Hind paw volumes were measured by water displacement in a 250 ml beaker using a top-loaded Mettler balance.

The results of this study showed that the incidence of arthritis in the treated group was decreased as compared with the control group, as measured both by clinical scores and foot volumes. The results of the foot volume measurements for each group of animals were averaged and are presented graphically on the accompanying FIG. 10, a plot of mean foot volume against days after induction of arthritis. The upper curve is derived from the control group of animals, the lower curve from the animals which received the course of injections of treated blood. A significant decrease in the severity of the arthritis, as indicated by lower foot volumes, is apparent for the treated animals as compared to the animals of the control group.

Although the invention has been described in connection with certain preferred embodiments, it is to be appreciated that it is not limited thereto. Rather, the present invention includes within its scope all embodiments which may fall within the scope of the following claims.

What is claimed is:

1. A method for inhibiting injury arising from hypertension or endothelial dysfunction in a mammalian subject which method comprises:

identifying a mammalian subject at risk of injury from hypertension or endothelial dysfunction;

administering to said subject three aliquots of said subject's modified blood according to the following regimen:

a) two aliquots of modified mammalian blood in a volume of about 0.1 ml to 100 ml on consecutive days; and

b) a third aliquot of modified mammalian blood in a volume of about 0.1 ml to 100 ml, after a rest period of 11 days after administration of the second aliquot,

wherein said blood is modified extracorporeally by exposure for a period of from about 2 to 5 minutes to a combination of stressors selected from the group consisting of a concentration of ozone from about 10 to 20  $\mu\text{g/ml}$ , UV light at a dosage of from about 0.1 to about 3  $\text{Joules/cm}^2$ ; and heating to a temperature above normal body temperature to about  $55^\circ \text{C}$ .

2. The method according to claim 1, wherein said injury arises from hypertension.

## 15

3. The method according to claim 1, wherein the injury arises from endothelial dysfunction.

4. A method for inhibiting injury arising from hypertension or endothelial dysfunction in a mammalian subject which method comprises:

identifying a mammalian subject at risk of injury from hypertension or endothelial dysfunction;

administering to said subject three aliquots of said subject's modified blood according to the following regimen:

a) two aliquots of modified mammalian blood in a volume of about 0.1 ml to 100 ml on consecutive days; and

b) a third aliquot of modified mammalian blood in a volume of about 0.1 ml to 100 ml, after a rest period of 11 days after administration of the second aliquot,

wherein said blood is modified extracorporeally by exposure for a period of about 3 minutes to a combination of stressors selected from the group consisting of a concentration of ozone from 13.5 to 15.5  $\mu\text{g}/\text{ml}$  at a flow rate of about 240 ml/minute, UV light at a dosage of from about 0.1 to about 3 joules/cm<sup>2</sup>; and a temperature of about 42.5° C.

## 16

5. A method for inhibiting injury arising from hypertension or endothelial dysfunction in a mammalian subject which method comprises:

identifying a mammalian subject at risk of injury of hypertension or endothelial dysfunction;

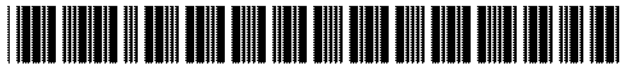
administering to said subject three aliquots of said subject's modified blood according to the following regimen:

a) two aliquots of modified mammalian blood in a volume of about 0.1 ml to 100 ml on consecutive days; and

b) a third aliquots of modified mammalian blood in a volume of about 0.1 ml to 100 ml, after a rest period of 11 days after administration of the second aliquot,

wherein said blood is modified extracorporeally by exposure for a period of about 2 to 5 minutes to a combination of stressors selected from the group consisting of a concentration of ozone from about 10 to 20  $\mu\text{g}/\text{ml}$ , UV light at a dosage of from about 0.1 to about 3 Joules/cm<sup>2</sup>; and heating to a temperature from about 40° to about 50° C.

\* \* \* \* \*



US006264646B1

(12) **United States Patent**  
**Stewart**

(10) **Patent No.:** **US 6,264,646 B1**  
(45) **Date of Patent:** **Jul. 24, 2001**

(54) **METHOD FOR PREVENTING AND REVERSING ATHEROSCLEROSIS IN MAMMALS**

4,968,483 11/1990 Müller et al. .  
5,591,457 1/1997 Bolton .  
5,834,030 11/1998 Bolton .

(75) **Inventor:** **Duncan J. Stewart, Toronto (CA)**

**FOREIGN PATENT DOCUMENTS**

(73) **Assignee:** **Vasogen Ireland Limited, Shannon (IE)**

2194485 11/1996 (CA) .  
1 068 428 11/1959 (DE) .  
WO 93/15778 8/1993 (WO) .  
WO 98/07436 2/1998 (WO) .

(\* ) **Notice:** Subject to any disclaimer, the term of this patent is extended or adjusted under 35 U.S.C. 154(b) by 0 days.

*Primary Examiner*—David J. Isabella  
*Assistant Examiner*—Kelly O'Hara  
(74) *Attorney, Agent, or Firm*—Burns, Doane, Swecker & Mathis, LLP

(21) **Appl. No.:** **09/304,262**  
(22) **Filed:** **May 6, 1999**

(57) **ABSTRACT**

**Related U.S. Application Data**

A method for delaying the onset, retarding the progression, and causing regression of atherosclerosis in a mammal comprises: (a) treating an aliquot of mammalian blood ex vivo with at least one stressor selected from the group consisting of a temperature above or below body temperature, ultraviolet light and an oxidative environment; and (b) administering the aliquot of blood treated in step (a) to the mammal, wherein the aliquot has a volume sufficient to achieve a reduction in lipid levels in the mammal.

(63) Continuation-in-part of application No. 09/190,236, filed on Nov. 13, 1998.

(51) **Int. Cl.<sup>7</sup>** ..... **A61M 31/00**

(52) **U.S. Cl.** ..... **604/522; 128/898; 250/432; 250/435; 250/504; 604/500**

(58) **Field of Search** ..... **128/898; 604/500; 604/522; 250/432, 435, 504**

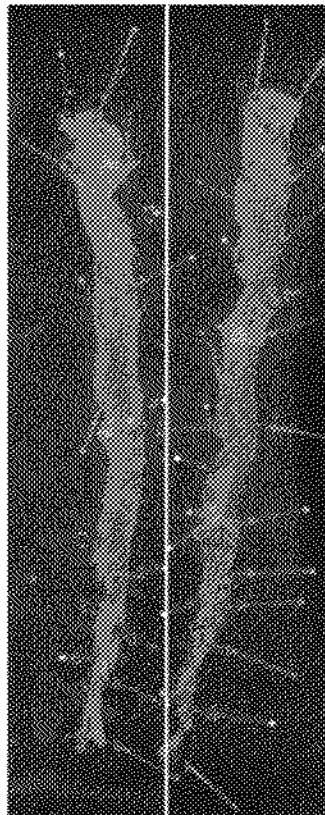
(56) **References Cited**

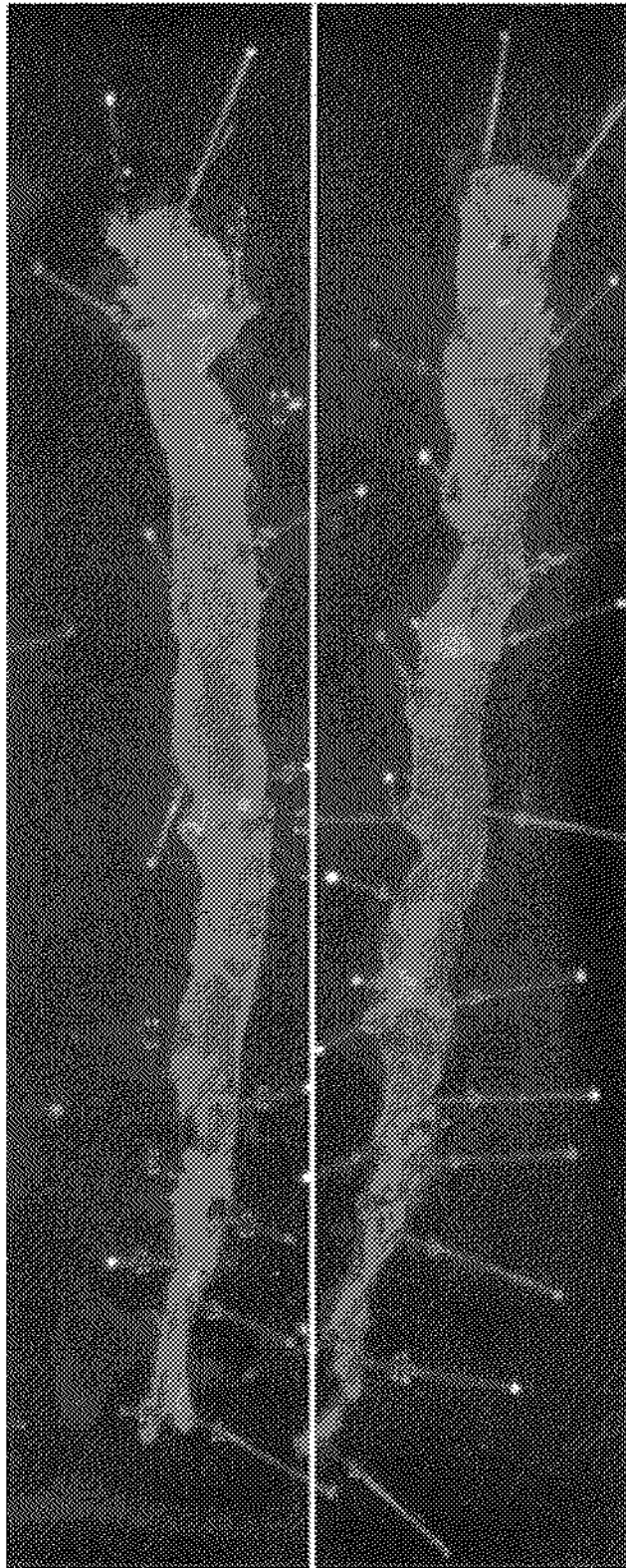
**22 Claims, 1 Drawing Sheet**

**U.S. PATENT DOCUMENTS**

4,831,268 5/1989 Fisch et al. .

**(1 of 1 Drawing Sheet(s) Filed in Color)**





**FIG.\_1A FIG.\_1B**

## METHOD FOR PREVENTING AND REVERSING ATHEROSCLEROSIS IN MAMMALS

This application is a continuation-in-part application of U.S. patent application Ser. No. 09/190,236 filed Nov. 13, 1998.

### FIELD OF THE INVENTION

This invention relates to treatment of blood, and to the use of treated, modified blood in connection with certain abnormal mammalian physical conditions and disease states. More specifically, it relates to modified mammalian blood and the treatment of cardiovascular disorders associated with elevated levels of lipids in the blood, in a mammalian subject, by administration to the subject of such modified blood.

### BACKGROUND OF THE INVENTION

Hyperlipidemias such as hypercholesterolemia and elevated serum triglyceride levels are among the most potent risk factors in the causation of atherosclerosis, which is the build-up of fatty plaque deposits within the walls of blood vessels. For example, high levels of serum cholesterol bound to low density lipoprotein (LDL), intermediate density lipoprotein (IDL) or very low density lipoprotein (VLDL) are known to correlate strongly with the occurrence of atherosclerosis in humans. In particular, it is believed that the higher the circulating levels of cholesterol in the form of LDL, IDL and VLDL cholesterol, and the higher the circulating levels of other lipids such as triglycerides, the more likely it is that cholesterol and lipids will be deposited within the blood vessel wall and cause or contribute to atherosclerosis.

In hypercholesterolemia, for example, the increase in the blood cholesterol level is associated mainly with a rise in the concentration of LDL, IDL and VLDL cholesterol. However, the specific causes of hypercholesterolemia are complicated and varied. At least one kind of hypercholesterolemia, known as familial hypercholesterolemia, is caused by a mutation in the gene for the LDL receptor that moves cholesterol out of the blood, primarily in the liver. Much more commonly, hypercholesterolemia has been associated with high dietary intake of saturated fatty acids and cholesterol, resulting in elevated blood cholesterol levels. High serum triglyceride levels have also been associated with high dietary intake of fatty acids.

Reduction of hyperlipidemia, including hypercholesterolemia, results in a delayed onset of atherosclerosis and a decrease in the progression of atherosclerosis, thus reducing the risk of coronary heart disease. In addition, there is evidence that relatively complicated plaques induced by hyperlipidemia can regress, and that further progression of atherosclerosis will decrease or cease when hyperlipidemia is removed. Some forms of hyperlipidemia, including hypercholesterolemia, are potentially partially reversible with current techniques of preventive management. Taking cholesterol-lowering drugs can result in a reduction in serum cholesterol, and other drugs may lower serum triglyceride levels. However, drugs are not always warranted for hyperlipidemia, and some lipid-lowering drugs may have serious side effects. Dietary therapy is usually recommended for all patients with hyperlipidemia but the effect is often not sufficient to reduce risk optimally.

Therefore, there is a need for a method which is effective in lowering blood lipid levels, especially cholesterol and triglyceride levels, and which does not have significant side effects.

### SUMMARY OF THE INVENTION

The present invention overcomes at least some of the above-noted and other disadvantages of presently known therapies for treatment of hyperlipidemia, such as hypercholesterolemia and elevated serum triglyceride levels, by providing a method for treating hyperlipidemia in which an aliquot of mammalian blood is treated *ex vivo* and subsequently introduced into the body of a mammalian subject.

The aliquot of blood is treated by being subjected to one or more stressors which have been found to modify the blood. According to the present invention, the blood aliquot can be modified by subjecting the blood, or separated cellular or non-cellular fractions of the blood, or mixtures of the separated cells and/or non-cellular fractions of the blood, to stressors selected from heat, ultraviolet light and oxidative environments such as treatment with ozone/oxygen mixtures, or any combination of such stressors, simultaneously or sequentially.

The observed effects of the modified blood of the present invention, when introduced into the mammalian subject's body, are several in number. Firstly, there is an observed reduction in total serum cholesterol levels, primarily due to a reduction in the levels of LDL and VLDL cholesterol. Levels of beneficial HDL cholesterol are not reduced. Reductions in cholesterol levels of as high as about 40 percent, as compared to subjects which received untreated blood as a placebo, have been observed. Secondly, there is an observed reduction in serum triglyceride levels. Such reductions in serum cholesterol and triglycerides would be expected to delay the onset and retard the progression of atherosclerosis due to hyperlipidemia.

Another of the observed effects of the treatment according to the present invention is that mammalian subjects treated according to the present invention show substantially reduced deposition of lipids within blood vessel walls, as compared to untreated subjects. As well as retarding the progression of plaque deposition, the treatment of the invention has been shown to cause existing plaques to regress. It is believed that this observed vessel protection is due at least in part to the reduced serum lipid levels in subjects treated by the method of the present invention. However, the reduced deposition of lipids within blood vessel walls has also been observed in the absence of a reduction in serum lipids.

Accordingly, in one aspect the present invention provides a method of reducing the serum level of a lipid in a mammal, comprising: (a) treating an aliquot of mammalian blood *ex vivo* with at least one stressor selected from the group consisting of a temperature above or below body temperature, ultraviolet light and an oxidative environment; and (b) administering the aliquot of blood treated in step (a) to the mammal, wherein the aliquot has a volume sufficient to achieve a reduction in the serum lipid level in the mammal.

In another aspect, the present invention provides a method of preventing or treating a condition in a mammalian subject, said method reducing the serum level of a lipid in the mammal and comprising (a) treating an aliquot of mammalian blood *ex vivo* with at least one stressor selected from the group consisting of a temperature above or below body temperature, ultraviolet light and an oxidative environment; and (b) administering the aliquot of blood treated in step (a) to the mammal, wherein the aliquot has a volume sufficient to achieve a reduction in the serum lipid level in the mammal.

### BRIEF DESCRIPTION OF THE DRAWINGS

The file of this patent contains at least one drawing executed in color. Copies of this patent with color drawing

(s) will be provided by the Patent and Trademark Office upon request and payment of the necessary fee.

The invention will now be more fully described, by way of example only, with reference to the accompanying drawings, in which.

FIG. 1 is a photograph showing two full length aortae obtained from LDL receptor deficient mice which underwent the study described in Example 1, the aorta labeled "A" being obtained from an animal which received a high cholesterol diet and sham treatments, and the aorta labeled "B" being obtained from an animal which received a high cholesterol diet and was treated according to a preferred method of the present invention, with aortic lipid deposition being made visible by staining the aortae with oil red O. FIG. 1 is identical to FIG. 1 of co-pending application no. 09/190,236, of which this application is a continuation-in-part, and which is incorporated herein by reference.

#### DETAILED DESCRIPTION OF PREFERRED EMBODIMENTS

According to a preferred process of the present invention, an aliquot of blood is extracted from a mammalian subject, preferably a human, and the aliquot of blood is treated *in vivo* with certain stressors, described in more detail below. The terms "aliquot", "aliquot of blood" or similar terms used herein include whole blood, separated cellular fractions of the blood including platelets, separated non-cellular fractions of the blood including plasma, and combinations thereof. The effect of the stressors is to modify the blood, and/or the cellular or non-cellular fractions thereof, contained in the aliquot. The modified aliquot is then re-introduced into the subject's body by any method suitable for vaccination, preferably selected from intra-arterial injection, intramuscular injection, intravenous injection, subcutaneous injection, intraperitoneal injection, and oral, nasal or rectal administration.

The stressors to which the aliquot of blood is subjected *in vivo* according to the method of the present invention are selected from temperature stress (blood temperature above or below body temperature), an oxidative environment and ultraviolet light, individually or in any combination, simultaneously or sequentially. Suitably, in human subjects, the aliquot has a volume sufficient that, when re-introduced into the subject's body, a reduction in a serum lipid level and/or a retardation in progression or a regression of atherosclerotic plaque formation is achieved in the subject. Preferably, the volume of the aliquot is up to about 400 ml, preferably from about 0.1 to about 100 ml, more preferably from about 5 to about 15 ml, even more preferably from about 8 to about 12 ml, and most preferably about 10 ml.

It is preferred, according to the invention, to apply all three of the aforementioned stressors simultaneously to the aliquot under treatment, in order to ensure the appropriate modification to the blood. It may also be preferred in some embodiments of the invention to apply any two of the above stressors, for example to apply temperature stress and oxidative stress, temperature stress and ultraviolet light, or ultraviolet light and oxidative stress. Care must be taken to utilize an appropriate level of the stressors to thereby effectively modify the blood to achieve a serum lipid reduction in the subject.

The temperature stressor warms the aliquot being treated to a temperature above normal body temperature or cools the aliquot below normal body temperature. The temperature is selected so that the temperature stressor does not cause excessive hemolysis in the blood contained in the aliquot

and so that, when the treated aliquot is injected into a subject, a lipid reduction and/or a retardation in progression or regression in the formation of atherosclerotic plaque will be achieved. Preferably, the temperature stressor is applied so that the temperature of all or a part of the aliquot is up to about 55° C., and more preferably in the range of from about -5° C. to about 55° C.

In some preferred embodiments of the invention, the temperature of the aliquot is raised above normal body temperature, such that the mean temperature of the aliquot does not exceed a temperature of about 55° C., more preferably from about 40° C. to about 50° C., even more preferably from about 40° C. to about 44° C., and most preferably about 42.5±1° C.

In other preferred embodiments: the aliquot is cooled below normal body temperature such that the mean temperature of the aliquot is within the range of from about -5° C. to about 36.5° C., even more preferably from about 10° C. to about 30° C., and even more preferably from is about 15° C. to about 25° C.

The oxidative environment stressor can be the application to the aliquot of solid, liquid or gaseous oxidizing agents. Preferably, it involves exposing the aliquot to a mixture of medical grade oxygen and ozone gas, most preferably by bubbling through the aliquot, at the aforementioned temperature range, a stream of medical grade oxygen gas having ozone as a minor component therein. The ozone content of the gas stream and the flow rate of the gas stream are preferably selected such that the amount of ozone introduced to the blood aliquot, either on its own or in combination with other stressors, does not give rise to excessive levels of cell damage such that the therapy is rendered ineffective. Suitably, the gas stream has an ozone content of up to about 300 µg/ml, preferably up to about 100 µg/ml, more preferably about 30 µg/ml, even more preferably up to about 20 µg/ml, particularly preferably from about 10 µg/ml to about 20 µg/ml, and most preferably about 14.5±1.0 µg/ml. The gas stream is suitably supplied to the aliquot at a rate of up to about 2.0 liters/min, preferably up to about 0.5 liters/min, more preferably up to about 0.4 liters/min, even more preferably up to about 0.33 liters/min, and most preferably about 0.24±0.024 liters/min. The lower limit of the flow rate of the gas stream is preferably not lower than 0.01 liters/min, more preferably not lower than 0.1 liters/min, and even more preferably not lower than 0.2 liters/min.

The ultraviolet light stressor is suitably applied by irradiating the aliquot under treatment from a source of UV light while the aliquot is maintained at the aforementioned temperature and while the oxygen/ozone gaseous mixture is being bubbled through the aliquot. Preferred UV sources are UV lamps emitting UV-C band wavelengths, i.e. at wavelengths shorter than about 280 nm. Ultraviolet light corresponding to standard LTV-A (wavelengths from about 315 to about 400 nm) and UV-B (wavelengths from about 280 to about 315) sources can also be used. For example, an appropriate dosage of such UV light, applied simultaneously with the aforementioned temperature and oxidative environment stressors, can be obtained from up to eight lamps arranged to surround the sample container holding the aliquot, operated at an intensity to deliver a total UV light energy at the surface of the blood of from about 0.025 to about 10 joules/cm<sup>2</sup>, preferably from about 0.1 to about 3.0 joules/cm<sup>2</sup>, may advantageously be used. Preferably, four such lamps are used.

The time for which the aliquot is subjected to the stressors is normally within the time range of up to about 60 minutes.

The time depends to some extent upon the chosen intensity of the UV light, the temperature, the concentration of the oxidizing agent and the rate at which it is supplied to the aliquot. Some experimentation to establish optimum times may be necessary on the part of the operator, once the other stressor levels have been set. Under most stressor conditions, preferred times will be in the approximate range of from about 2 to about 5 minutes, more preferably about 3 minutes. The starting blood temperature, and the rate at which it can be warmed or cooled to a predetermined temperature, tends to vary from subject to subject. Such a treatment provides a modified blood aliquot which is ready for injection into the subject.

In the practice of the preferred process of the present invention, the blood aliquot may be treated with the stressors using an apparatus of the type described in U.S. Pat. No. 4,968,483 to Mueller. The aliquot is placed in a suitable, sterile, UV light-transmissive container, which is fitted into the machine. The UV lamps are switched on for a fixed period before the gas flow is applied to the aliquot providing the oxidative stress, to allow the output of the UV lamps to stabilize. The UV lamps are typically on while the temperature of the aliquot is adjusted to the predetermined value, e.g.  $42.5 \pm 1^\circ \text{C}$ . Then the oxygen/ozone gas mixture, of known composition and controlled flow rate, is applied to the aliquot, for the predetermined duration of up to about 60 minutes, preferably 2 to 5 minutes and most preferably about 3 minutes as discussed above, so that the aliquot experiences all three stressors simultaneously. In this way, blood is appropriately modified according to the present invention to achieve the desired effects.

The invention is further illustrated and described with reference to the following specific examples.

#### EXAMPLE 1

##### Animal Studies Model

The purpose of the experiment is to determine the effects of treatment according to the present invention on the development of atherosclerosis in the LDL receptor (LDL-R) deficient mouse model, a widely used transgenic atherosclerosis model created by targeted disruption of the LDL receptor. This animal model is analogous to familial hypercholesterolemia, an inherited condition in which a mutation results in complete lack of functional LDL-R. In the human disease, homozygous individuals demonstrate a marked increase in serum cholesterol and develop severe premature atherosclerosis, often succumbing to this disease at an early age. In patients with this disease, currently used lipid lowering agents do not have a significant effect in terms of lowering cholesterol levels.

The LDL-R deficient mouse model shows intolerance to cholesterol feeding and develops widespread atherosclerotic changes which progress to mature fibrous lesions morphologically indistinguishable from established human atherosclerosis. Apart from the defined genetic abnormality causing predisposition to atherosclerosis, this model has the advantage of rapid development of widespread atherosclerosis within 6 to 8 weeks following institution of cholesterol feeding.

##### Protocol:

LDL-R deficient mice were purchased from Jackson Laboratories. A total of 20 mice were entered into the study at 22 weeks of age, and 15 mice completed the study. The length of the study was 8 weeks. The mice were maintained on a 12 hour dark/12 hour light cycle with free access to food and water, and were fed a specified diet as follows. A control

group comprised of 5 animals, all of which completed the study, received a normal diet. The high cholesterol group comprising 15 animals, of which 10 completed the study, were fed a diet containing 1.25% cholesterol, 7.5% cocoa butter, 7.5% casein, and 0.5% sodium cholate. To ensure proper food intake, food consumption and animal weight were monitored on a weekly basis. In previous experiments, it was demonstrated that 8 weeks of feeding with the high cholesterol diet results in substantial atherosclerosis development, particularly in the aortic arch and the descending thoracic aorta.

##### Treatment:

Ten of the animals fed the high cholesterol diet were selected at random to undergo a course of treatment by the preferred method of the invention. Six of the treated animals completed the study. It is to be noted that the four deaths in this group were not in any way related to the treatment, but occurred early in the study as a result of fighting among animals which were housed together during the study. The other five animals on the high cholesterol diet underwent a course of sham treatments, and four survived the protocol.

The treatments began four weeks after initiation of the study, with each of the animals on the high cholesterol diet receiving a total of 10 treatments (2 courses of treatment of 1 injection per day for 5 days, the 2 courses of treatment separated by two days, i.e. 10 injections over a period of 12 days). Each individual treatment administered to the animals treated by the method of the present invention consisted of the collection of 10 ml of blood from genetically compatible donor animals fed on a normal diet, the blood being collected into sodium citrate anticoagulant. In order to collect each 10 ml aliquot of blood, about 1 ml of blood was extracted from each of 10 animals. The blood was extracted by cardiac puncture, with the animals being under fill xylazine/ketamine anesthesia during the blood extraction procedure, and being given T-61 immediately following extraction. The blood aliquot was transferred to a sterile, disposable, low-density polyethylene vessel for *ex vivo* treatment, and was then treated simultaneously with a gaseous oxygen/ozone mixture and ultraviolet light at elevated temperature using an apparatus as generally described in aforementioned U.S. Pat. No. 4,968,483 to Mueller et al.

The constitution of the gas mixture was  $14.5 \pm 1.0 \mu\text{g}$  ozone/ml, with the remainder of the mixture comprising medical grade oxygen. The gas mixture was bubbled through the aliquot at a rate of  $240 \pm 24 \text{ ml/min}$  for a period of 3 minutes. The temperature of the aliquot was held steady at  $42.5 \pm 1.0^\circ \text{C}$ . The UV light was within the UV-C band, and included a wavelength of 253.7 nm.

After treatment by the preferred method of the present invention, 30  $\mu\text{l}$  of the treated blood was re-injected intramuscularly into each animal undergoing treatment according to the present invention.

In the sham treatments, 30  $\mu\text{l}$  of untreated blood was injected intramuscularly into each of the remaining five animals on the high cholesterol diet.

##### Assessment of Atherosclerosis:

After 8 weeks, the animals were anesthetized with xylazine/ketamine and the heart was exposed. After nicking the vena cava to obtain blood samples, the animals were perfused via ventricular puncture, first with PBS to flush out the blood and then with 10% neutral buffered formalin for 3 minutes to fix the aorta. The thoracic aorta was dissected away from the thorax en bloc and stored in 10% formalin at  $4^\circ \text{C}$ . Pressure-fixed (10% formalin) aortae were removed en bloc and opened to allow a longitudinal full length inversion. The aortae were then mounted internally exposed on glass

slides and stained with oil red O. The bright red staining (indicating lipid deposition) was then quantified using a computer assisted morphometric system, and expressed as a percentage of total aortic intimal surface.

Plasma Lipid and Lipoprotein Analysis:

Lipoprotein profiles were obtained by means of fast-phase liquid chromatography with a Superose 6B column. 200  $\mu$ l aliquots of platelet-poor plasma from each animal were loaded onto the column and eluted with TSE buffer at a constant flow rate of 0.35 ml/min. An aliquot of 80  $\mu$ l from each fraction was used for the measurement of total cholesterol minus esterified cholesterol. Total cholesterol and triglycerides in plasma samples and column fractions for 11 representative animals were measured by an enzymatic method established in the lipid research group at St. Michael's Hospital, Toronto.

Statistical Analysis:

Continuous variables are reported as mean  $\pm$ SD. Differences in cholesterol levels and triglyceride levels among groups were tested by Student's t-test. Differences in atherosclerotic lesion area among groups were tested using the one-way ANOVA test in conjunction with the Bonferroni correction.

Results:

The measurement of the cholesterol levels among the different groups of animals showed that the total serum cholesterol level did not change significantly in the animals which received the normal diet, but was markedly increased in the animals receiving the high cholesterol diet. This marked increase occurred both in the sham treated group and to a lesser extent in the group which received the treatments according to the preferred method of the present invention.

The measured triglyceride levels were also higher in the animals which received the high cholesterol diet, as compared to the animals which received the normal diet. However, among the animals which received the high cholesterol diet, the increase in triglyceride levels was much greater in the sham treated group than in the group which was treated according to the preferred method of the present invention.

The measured cholesterol and triglyceride levels, and the average cholesterol and triglyceride levels for each group, are shown below in Table I.

TABLE I

GROUP	ANIMAL	CHOLESTEROL (mM)	TRIGLYCERIDES (mM)
Treated	1	12.99	0.305
Treated	2	13.19	0.336
Treated	3	16.22	0.348
Treated	4	14.87	0.397
	Average (1-4)	14.3 $\pm$ 1.5	0.35 $\pm$ 0.04
Control	6	4.41	0.341
Control	7	5.15	0.397
Control	8	5.73	0.440
	Average (6-8)	5.1 $\pm$ 0.7	0.39 $\pm$ 0.05
HC Diet	11	27.52	0.697
HC Diet	12	26.59	0.720
HC Diet	13	23.45	0.605
HC Diet	14	24.56	0.636
	Average (11-14)	25.5 $\pm$ 1.9	0.66 $\pm$ 0.05

In Table I, the "Treated" group of animals received the high cholesterol diet and were treated according to the preferred method of the present invention, the "Control" animals received the normal diet and no treatment, and the "HC Diet" animals received the high cholesterol diet and the sham treatment. From the above data, it is apparent that the ratio of the average cholesterol level of the HC Diet group

to that of the Control group is 5.01:1 ( $p=0.0000051$ ), whereas the ratio of the average cholesterol level of the Treated group to that of the Control group is 2.81:1 ( $p=0.00010$ ). Therefore, the increase in the average cholesterol level of the Treated group is significantly lower than the increase in the average cholesterol level of the HC Diet group, with the ratio of the average cholesterol level of the Treated group to that of the HC Diet group being 0.56:1 ( $p=0.000043$ ). These variations in cholesterol level occurred primarily in the LDL and VLDL fractions. In addition, it was found that there was no significant difference in the serum level of HDL cholesterol between the Treated and HC groups. Therefore, the treatment of the present invention does not bring about a reduction in serum HDL cholesterol, which is believed to be beneficial.

It is also apparent from the above data that the ratio of the average triglyceride level of the HC Diet group to that of the Control group is 1.69:1 ( $p=0.00050$ ), whereas the ratio of the average triglyceride level of the Treated group to that of the Control group is 0.88:1 ( $p=0.11$ ). Therefore, the increase in the average triglyceride level of the Treated group is significantly lower than the increase in the average triglyceride level of the HC Diet group, with the ratio of the average triglyceride level of the Treated group to that of the HC Diet group being 0.52:1 ( $p=0.000034$ ).

EXAMPLE 2

Human Studies

The reduction in triglyceride levels observed in the animal studies is consistent with results obtained in two human studies, the results of which are presented below.

Human Study A

A total of 94 healthy human volunteers, of which 57 were males and 37 were females, were given a course of six treatments according to the preferred method of the present invention over a two week period. Serum triglyceride levels were measured before and after the course of treatments, and the average measurements are shown below in Table 2.

TABLE 2

Pre-treatment triglyceride level (mg/dl)	Post-treatment triglyceride level (mg/dl)	Significance (p)
146	134	0.04

Human Study B

A total of 49 patients from family practice were given various schedules of treatments according to the preferred method of the present invention. The treatments comprised from 5 to 40 injections per patient. Serum triglyceride levels of each patient were measured before and after the course of therapy and the average measurements are presented below in Table 3.

TABLE 3

Pre-treatment triglyceride level (mg/dl)	Post-treatment triglyceride level (mg/dl)	Significance (p)
135.4	121.9	<0.05

From the above human studies, it can be concluded that the treatment according to the preferred method of the present invention achieves a significant reduction in total serum triglyceride levels in human subjects.



## EXAMPLE 3

## Animal Studies

In this study, LDL-R deficient mice were divided into groups and studied using the following protocol:

Group A (control)—fed a normal diet as in Example 1;

Group B1—fed a high cholesterol diet as described in Example 1 for 8 weeks;

Group B2—fed a high cholesterol diet as described in Example 1 for 12 weeks,

Group C1—fed a high cholesterol diet as described in Example 1 for 8 weeks, and treated by the preferred method of the present invention as described in Example 1 at 4 weeks of dietary intervention; and

Group C2—fed a high cholesterol diet as described in Example 1 for 12 weeks, and treated by the preferred method of the present invention as described in Example 1 at 8 weeks of dietary intervention.

For each group of animals, atherosclerotic area was assessed at either 8 or 12 weeks according to the method described in Example 1 under the heading "Assessment of Atherosclerosis". As demonstrated by measurement of atherosclerotic area, the animals of group B (high cholesterol diet alone) exhibited substantial aortic lipid deposition, with group B1 animals having levels of  $0.16 \pm 0.1$  at eight weeks and group B2 animals having levels of  $0.17 \pm 0.1$  at 12 weeks of dietary intervention. In contrast, the animals of group C (high cholesterol diet with treatment according to the invention) exhibited profoundly reduced lipid deposition, with group C1 animals having levels of  $0.04 \pm 0.03$  ( $p < 0.05$ ) at eight weeks of dietary intervention, and group C2 animals having levels of  $0.04 \pm 0.02$  ( $p < 0.01$ ) at twelve weeks of dietary intervention.

The animals of group C also exhibited a marked reduction in xanthelasma and limb swelling as compared to animals of group B.

Total lipoprotein profiles were measured as in Example 1 by fast-phase liquid chromatography and an enzyme-linked assay. The results of this analysis showed that the animals of group B (high cholesterol diet alone) had markedly increased levels of total serum cholesterol (CHO  $25.5 \pm 1.9$  mM and triglycerides as compared to control group A (CHO  $5.1 \pm 0.7$  mM). This is to be contrasted with the animals of group C, which showed a significant reduction in both cholesterol (CHO  $14.3 \pm 1.5$  mM;  $p < 0.01$  for B vs. C) and triglycerides as compared to the animals of group B.

## Conclusions:

The treatment according to the preferred method of the present invention achieved about a forty percent reduction in total serum cholesterol and a significant reduction in triglyceride levels, and substantially inhibited the development of atherosclerosis in a mouse model of human familial hypercholesterolemia. In addition to substantially reducing the development of atherosclerosis at an early stage and inhibiting the progression of established atherosclerotic lesions, the treatment according to the preferred method of the present invention was shown to cause regression of existing atherosclerotic lesions. This can be seen for example by comparing the results for the animals of subgroups B1 and C2 in Example 2, which show that existing plaque deposits at week eight of a high cholesterol diet are reduced by about 75% when the animals are treated at week eight according to the present invention. These improvements in cardiovascular health were accompanied by improvements in the animals' general overall appearance and appetite. It is believed that the atherosclerosis inhibitory effect is at least partially due to the reduction in cholesterol and triglyceride levels. However, the retardation in progres-

sion and regression of the formation of atherosclerotic plaques is not necessarily accompanied by a reduction in serum lipid levels.

Furthermore, the treatment of the present invention is capable of not only preventing increases in serum lipid levels caused by a high cholesterol diet, but is also effective in reducing existing moderate to high lipid levels.

Although the invention has been described with reference to specific preferred embodiments, it will be appreciated that many variations may be made to the invention without departing from the spirit or scope thereof. All such modifications are intended to be included within the scope of the following claims.

What is claimed is:

1. A method of causing regression of an existing atherosclerotic lesion in a mammal with atherosclerosis, comprising:

(a) treating mammalian blood *ex vivo* with at least one stressor selected from the group consisting of a temperature above or below body temperature, ultraviolet light and an oxidative environment; and

(b) administering the mammalian blood treated in step (a) to the mammal in an amount sufficient to achieve a regression in said existing atherosclerotic lesion in the mammal.

2. The method of claim 1, wherein the oxidative environment comprises applying an oxidizing agent to the aliquot.

3. The method of claim 2, wherein the oxidizing agent contains ozone gas, and the ozone gas is introduced into the blood aliquot in an amount which does not give rise to excessive levels of mutagenicity.

4. The method of claim 2, wherein the oxidizing agent comprises a mixture of ozone gas and medical grade oxygen, the ozone gas being contained in the mixture in a concentration of up to about 300  $\mu\text{g}/\text{ml}$ .

5. The method of claim 4, wherein the ozone gas is contained in the mixture in a concentration of up to about 30  $\mu\text{g}/\text{ml}$ .

6. The method of claim 1, wherein the mixture is applied to the aliquot at a flow rate of up to about 0.33 liters/min.

7. The method of claim 1, wherein the ultraviolet light comprises one or more UV-C band wavelengths.

8. The method of claim 1, wherein the temperature to which the aliquot is cooled or heated is a temperature which does not result in substantial hemolysis of the blood in the aliquot.

9. The method of claim 1, wherein the temperature stressor is applied so that the temperature of at least part of the aliquot is in the range of from about  $-5^\circ\text{C}$ . to about  $55^\circ\text{C}$ .

10. The method of claim 1, wherein the mean temperature of the blood in the aliquot is in the range of from about  $37^\circ\text{C}$ . to about  $44^\circ\text{C}$ .

11. The method of claim 1, wherein the mean temperature of the blood in the aliquot is in the range of from about  $0^\circ\text{C}$ . to about  $36.5^\circ\text{C}$ .

12. The method of claim 1, wherein the mean temperature of the blood in the aliquot is in the range of from about  $10^\circ\text{C}$ . to about  $30^\circ\text{C}$ .

13. The method of claim 1, wherein the temperature is in the range of from about  $37^\circ\text{C}$ . to about  $55^\circ\text{C}$ .

14. The method of claim 13, wherein the temperature is  $42.5 \pm 1^\circ\text{C}$ .

15. The method of claim 1, wherein the volume of the aliquot is up to about 400 ml.

16. The method of claim 15, wherein the volume of the aliquot is about 10 ml.

11

17. The method of claim 1, wherein the aliquot is subjected to the stressors for a period of up to about 60 minutes.

18. The method of claim 17, wherein the aliquot is subjected to the stressors for a period of about 3 minutes.

19. The method of claim 1, wherein the blood is administered to the mammal by a method suitable for vaccination selected from the group consisting of intra-arterial injection, intramuscular injection, intravenous injection, subcutaneous injection, intraperitoneal injection, and oral, nasal or rectal administration.

12

20. The method of claim 1, wherein all of the stressors are simultaneously administered to the aliquot.

21. The method of claim 1, wherein any two of the stressors are simultaneously administered to the aliquot.

22. The method of claim 1, wherein the blood treated in step (a) is provided by removing the blood from the same mammal to which the treated blood is administered in step (b).

\* \* \* \* \*



US006669965B2

(12) **United States Patent**  
**Bolton**

(10) **Patent No.:** **US 6,669,965 B2**  
(45) **Date of Patent:** **\*Dec. 30, 2003**

(54) **METHOD OF TREATING**  
**ATHEROSCLEROSIS**

(75) Inventor: **Anthony E. Bolton**, Tideswell (CA)

(73) Assignee: **Vasogen Ireland Limited**, County  
Clare (IE)

(\* ) Notice: This patent issued on a continued prosecution application filed under 37 CFR 1.53(d), and is subject to the twenty year patent term provisions of 35 U.S.C. 154(a)(2).

Subject to any disclaimer, the term of this patent is extended or adjusted under 35 U.S.C. 154(b) by 0 days.

This patent is subject to a terminal disclaimer.

(21) Appl. No.: **09/436,243**

(22) Filed: **Nov. 9, 1999**

(65) **Prior Publication Data**

US 2002/0086064 A1 Jul. 4, 2002

**Related U.S. Application Data**

(63) Continuation-in-part of application No. 08/754,348, filed on Nov. 22, 1996, now Pat. No. 5,980,954, which is a continuation-in-part of application No. 08/352,802, filed on Dec. 1, 1994, now Pat. No. 5,591,457, which is a continuation-in-part of application No. 07/941,327, filed on Sep. 4, 1992, now abandoned, which is a continuation-in-part of application No. 07/832,798, filed on Feb. 7, 1992, now abandoned.

(51) **Int. Cl.**<sup>7</sup> ..... **A61K 33/00; A61K 35/14**

(52) **U.S. Cl.** ..... **424/613; 424/93.7; 424/93.71; 424/529; 424/534; 514/824; 604/4.01; 604/6.08**

(58) **Field of Search** ..... 250/493.1; 422/24, 422/44, 45, 46; 424/613, 810, 93.7, 93.71, 529, 534; 514/824, 929; 435/2, 372, 375, 377; 604/4, 4.01, 6.08

(56) **References Cited**

**U.S. PATENT DOCUMENTS**

695,657 A	3/1902	Smith	604/25
3,715,430 A	2/1973	Ryan	424/613
3,925,344 A	12/1975	Mazur	530/385
4,061,736 A	12/1977	Morris et al.	514/6
4,473,496 A	9/1984	Scannon	530/385
4,500,534 A	2/1985	Fiebel et al.	514/301
4,529,719 A	7/1985	Tye	514/6
4,584,130 A	4/1986	Bucci et al.	530/385
4,600,531 A	7/1986	Walder	530/385
4,632,980 A	12/1986	Zee et al.	530/380
4,659,726 A	4/1987	Yoshino et al.	514/365
4,826,811 A	5/1989	Schgal et al.	514/6
4,831,268 A	5/1989	Fisch et al.	250/432 R
4,857,636 A	8/1989	Hsia	530/385
4,968,483 A	11/1990	Müller et al.	422/45
4,983,637 A	1/1991	Herman	514/724
5,028,588 A	7/1991	Hoffman et al.	514/6
5,052,382 A	10/1991	Wainwright	128/202.25

5,194,590 A	3/1993	Sebgal et al.	530/385
5,250,665 A	10/1993	Kluger et al.	530/385
5,591,457 A	1/1997	Bolton	424/613
5,834,030 A	11/1998	Bolton	424/613
5,980,954 A	* 11/1999	Bolton	424/613
6,264,646 B1	* 7/2001	Stewart	604/522

**FOREIGN PATENT DOCUMENTS**

DE	1068428	5/1957
DE	2926523	1/1981
EP	0 111 418 A	6/1984
EP	0 284 409 A	9/1988
JP	58198466	2/1984
WO	WO 92 10198 A	6/1992
WO	93/15778	8/1993
WO	WO 96/34613	11/1996
WO	98/07436	2/1998

**OTHER PUBLICATIONS**

Caulada-Benedetti, Z., et al. "Comparison of Th1-and Th2-Associated Immune Reactivities Stimulated by Single Versus Multiple Vaccination of Mice with Irradiated *Schistosoma mansoni* Cercariae." *J. Immunol.* 146(5): 1655-1660 (1991).

Chemical Abstracts. 100: 99189m (1984).

Murina, M.A., et al. "Changes in erythrocyte and thrombocyte aggregation after ultraviolet irradiation." *Biofizika.* 29(1): 92-95 (1984). (Summary in English).

*Physician's Guide to Rare Diseases.* Thoene, et al. (eds.) Dowden Publishing Co., NJ. 787-790 (1992).

Edelson, "Photopheresis: a Clinically Relevant Immunobiologic Response Modifier," *Annals of the New York Academy of Sciences*, Jan., 1991, pp 154-164, vol. 636.

Knobler et al., "Parenteral administration of 8-methoxypsoralen in photopheresis," *J. Am. Acad. Dermatol.*, 1993, pp. 580-584, vol. 28, No. 4.

Rook et al., "Extracorporeal photochemotherapy in the treatment of cutaneous T cell lymphoma and autoimmune disorders affecting the skin," *Ciba Foundation Symposium*, 1989, pp. 171-177, vol. 146.

Harrison's Principles of Internal Medicine (1994, 13th Ed.), pp. 1106-1116.\*

(List continued on next page.)

*Primary Examiner*—Jose' G. Dees

*Assistant Examiner*—Frank Choi

(74) *Attorney, Agent, or Firm*—Burns, Doane, Swecker & Mathis LLP

(57) **ABSTRACT**

A method of treating or preventing atherosclerosis in a mammalian subject comprises: (a) extracting the aliquot of blood from the subject; (b) treating the aliquot of blood *ex vivo* with at least one stressor selected from the group consisting of an oxidizing agent, ultraviolet radiation and elevated temperature; and (c) administering the aliquot of blood treated in step (b) to the subject. Preferably, the aliquot has a volume of from about 0.01 ml to about 400 ml and is treated simultaneously by ozone gas and ultraviolet radiation at a temperature of from 37-55° C.

**9 Claims, 5 Drawing Sheets**

**(4 of 5 Drawing Sheet(s) Filed in Color)**

## OTHER PUBLICATIONS

Harrison's Principles of Internal Medicine (1980, 9th Ed.), pp. 1156-1166.\*

Medline Abstract 91104111, abstracting: Petukhov, E.B. et al, "Correction of Blood Hyperviscosity . . ." *Grud Seronechnosudistaia Khir*, (1990) (10), pp. 34-37.

Medline Abstract 90020932, abstracting: Petukhov, E.B. et al. "Decreased Activity of Lipid . . .", *Vestn Khir* (May 1989), vol. 142(5), pp. 36-39.

Medline Abstract 80130497, abstracting: Vella Briffa D. et al. "Inhibition of human blood platelet aggregation . . ." *Br. J. Dermatol.* (Dec. 1979), vol. 101(6), pp. 679-683.

Drug Facts and Comparisons, 1994 edition, published by Facts and Comparisons, St. Louis, see pp. 263-269.

Cecil Textbook of Medicine, 19<sup>th</sup> ed., published by W.B. Saunders Co., PA, 1992, pp. 253-269, 823, 1085, 1530-1534 and 2161.

Physicians' Desk Reference, 47<sup>th</sup> ed., published by Medical Economics Data, NJ, 1993, pp. 710 and 2408-2411.

Rook, Alain H. et al., "Treatment of Autoimmune Disease with Extracorporeal Photochemotherapy: progressive systemic sclerosis," *The Yale J. of Biology and Medicine*, vol. 62, No. 6, Nov./Dec. 1989, pp. 639-645.

Tattoni, G. et al., "Osservazioni sull'efficacia di un trattamento balneoterapico ozonizzato in pazienti affetti da vasculopatie periferiche," *Minerva Cardioangiologica*, vol. 25/9, 1997, pp. 745-748.

"Cloned and Expressed Nitric Oxide Synthase Structurally Resembles Cytochrome P-450 Reductase," *Nature*, Jun. 27, 1992, vol. 351, pp. 714-718.

*British Medical Journal*, vol. 296, Jan. 30, 1988, pp. 320-331, entitled "Secondary Prevention of Vascular Disease by Prolonged Antiplatelet Treatment".

"Ozone: Historical Review," published in *Biomedical Technology*, Dec. 16, 1991, p. 5.

"Biological Roles of Nitric Oxide," *Scientific American*, May 1992, pp. 68-77.

D. Baran et al (associates) "Technical Report and Clinical Update" Mueller Medical International Inc., Oakville, Ontario, Canada, Sep. 1990.

Harbrecht, B.G., "Nitric Oxide Synthesis Serves to Reduce Hepatic Damage During Acute Murine Endotoxemia," *Critical Care Med.* 20(11): 1568-1574 (1992).

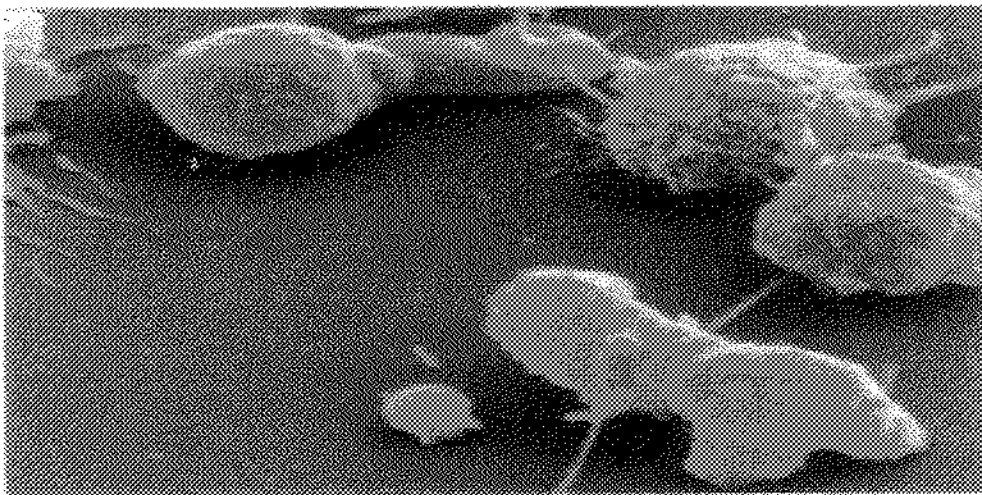
Hishikawa, K., et al. "Effect of systemic L-arginine administration on hemodynamics and nitric oxide release in man." *Jap. Heart Jnl.* 33(1): 41-48 (1992).

Thomsen, L.L., et al. "Tumor-Dependent Increased Plasma Nitrate Concentrations as an Indication of the Antitumor Effect of Flavone-8-Acetic Acid and Analogues in Mice," *Cancer Research.* 51(1): 77-81 (1991).

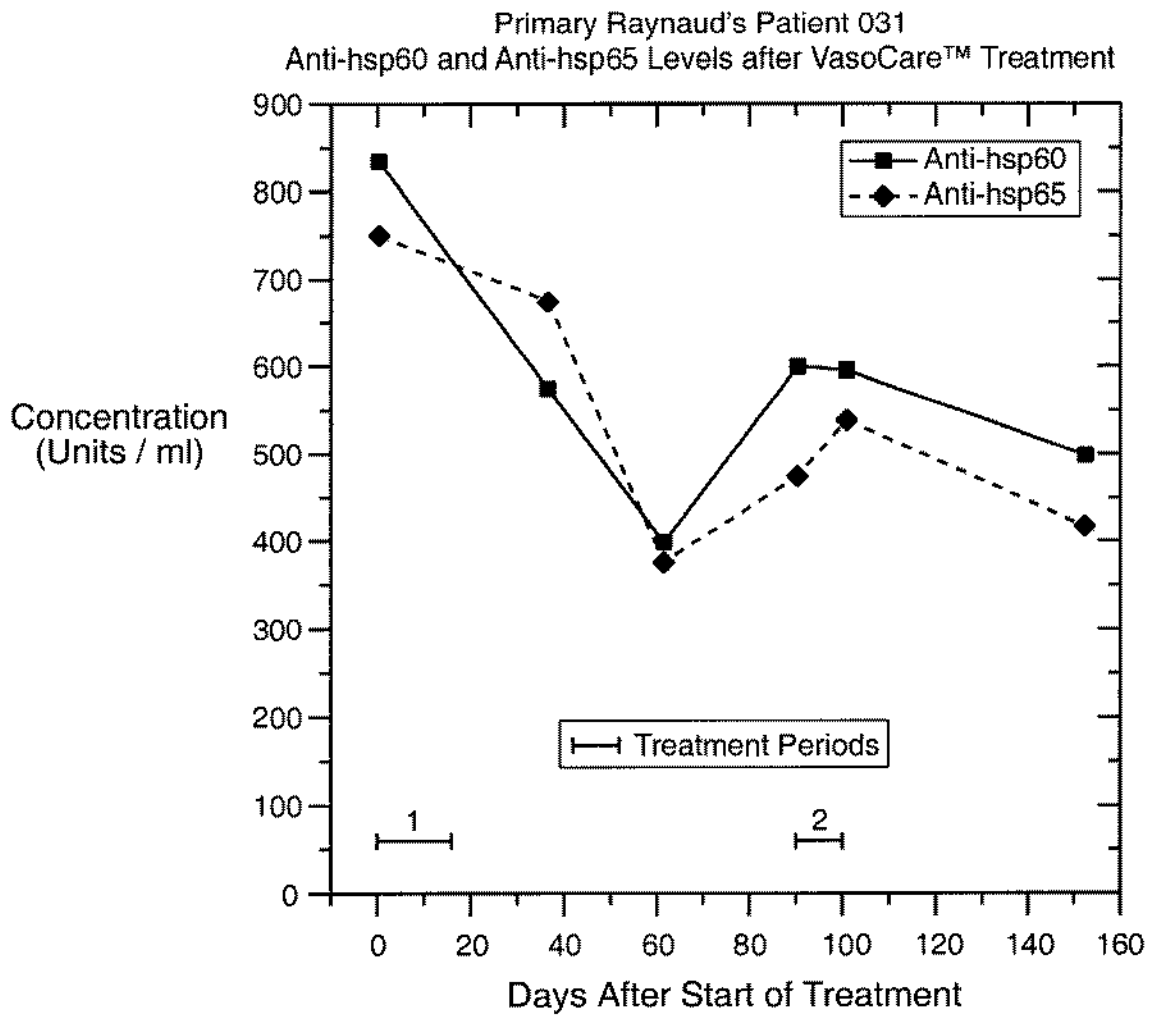
\* cited by examiner



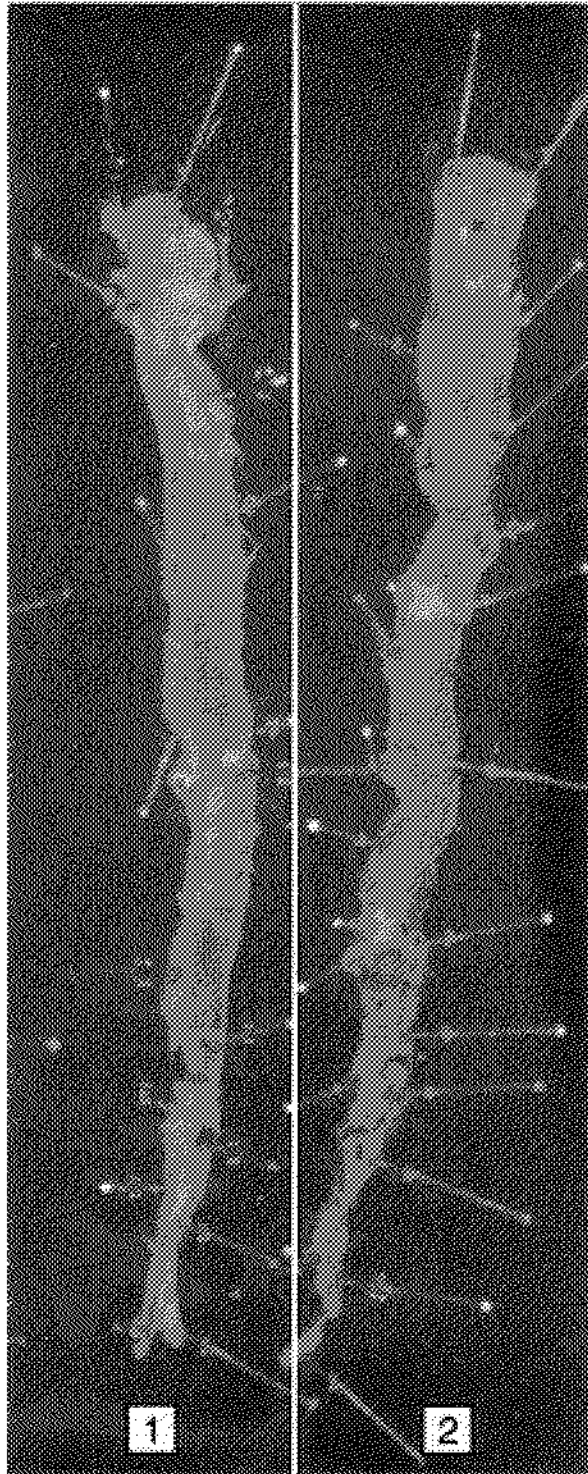
**FIG. 1A**



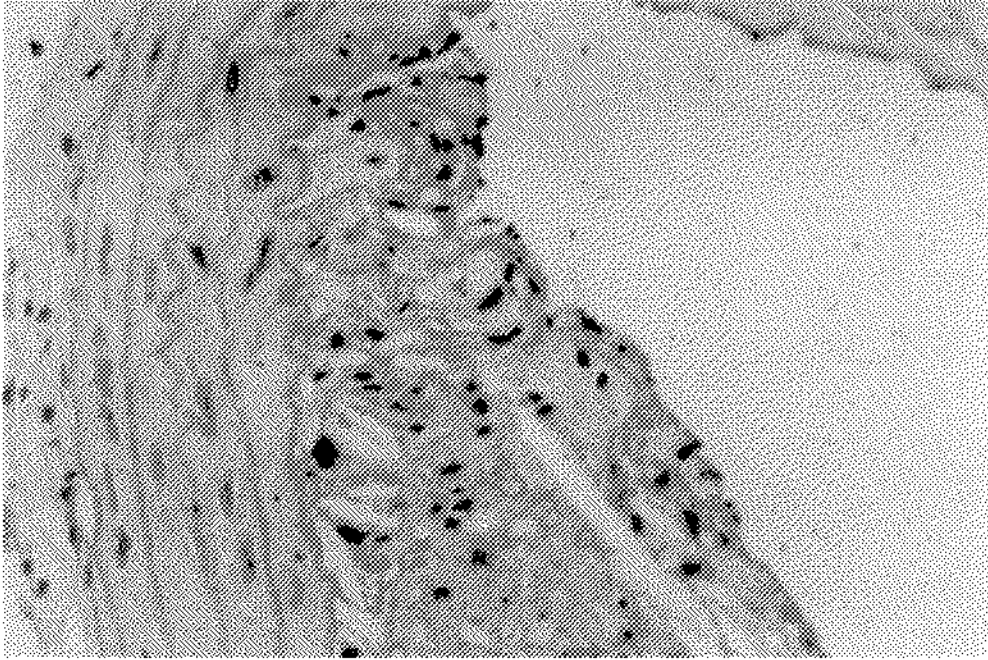
**FIG. 1B**



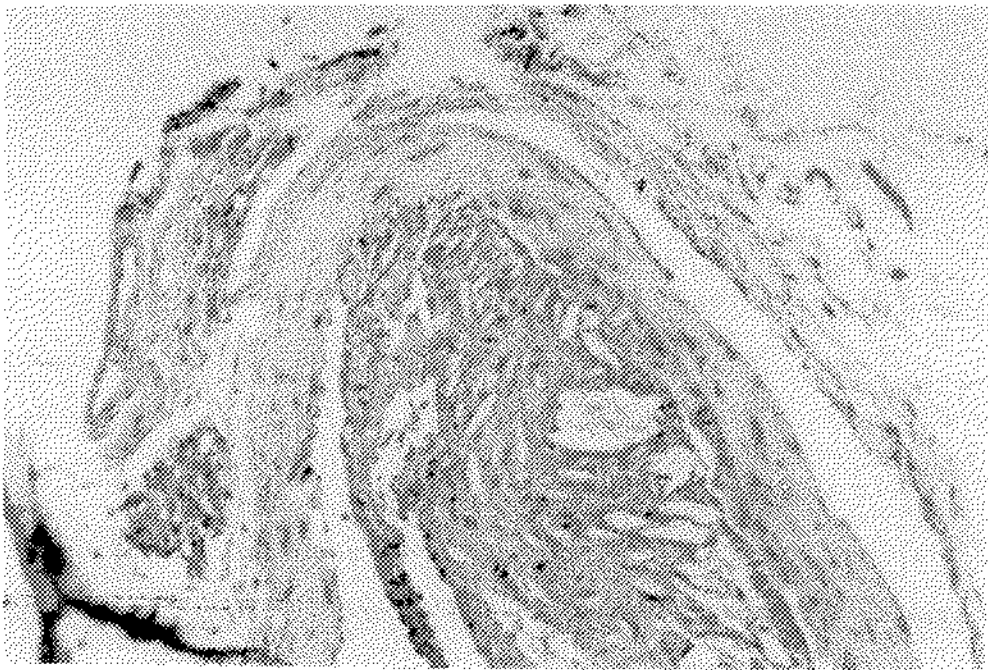
**FIG. 2**



**FIG.\_3A FIG.\_3B**

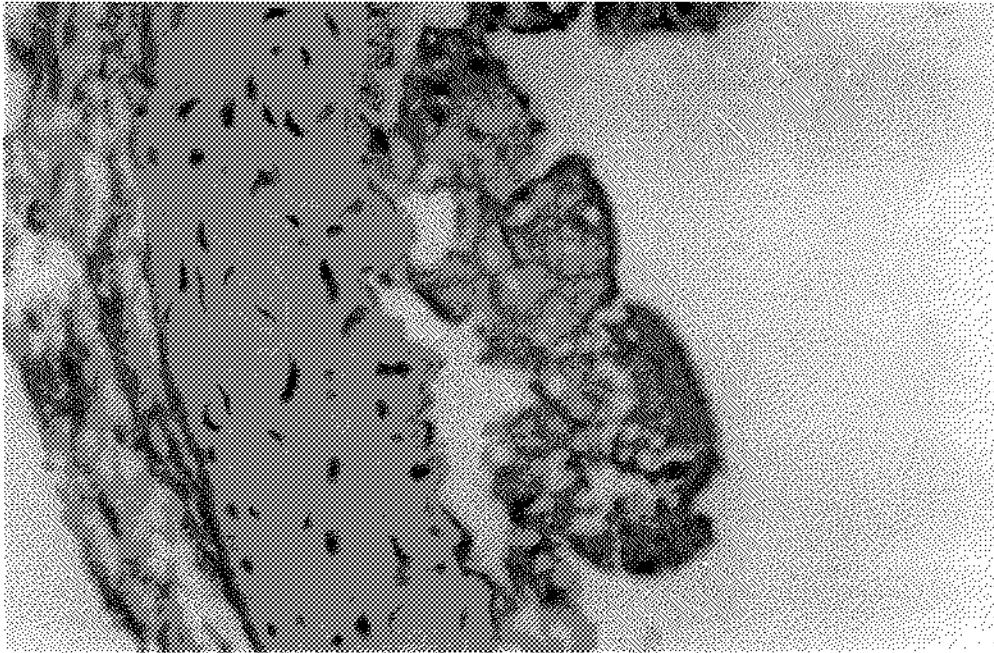


**FIG.\_4**



**FIG.\_5**





**FIG. 6**

## METHOD OF TREATING ATHEROSCLEROSIS

### CROSS-REFERENCE TO RELATED APPLICATIONS

This application is a continuation-in-part of U.S. patent application Ser. No. 08/754,348, filed Nov. 22, 1996 which is issued Nov. 9, 1999 as U.S. Pat. No. 5,980,954 which is a continuation-in-part of U.S. patent application Ser. No. 08/352,802 filed Dec. 1, 1994 and which issued on Jan. 7, 1997 as U.S. Pat. No. 5,591,457, which is in turn a continuation-in-part of U.S. patent application Ser. No. 07/941,327 filed Sep. 4, 1992 and now abandoned, which was in turn a continuation-in-part of U.S. patent application Ser. No. 07/832,798 (now abandoned) filed Feb. 7, 1992.

### FIELD OF THE INVENTION

This invention relates to vaccines, their preparation and use in medical treatments. More particularly, it relates to treatments for alleviating autoimmune diseases and their symptoms, to a vaccine useful therein, and to processes for preparing and using such a vaccine. In one particularly preferred aspect, the present invention relates to methods for treating and preventing atherosclerosis.

### BACKGROUND OF THE INVENTION

Autoimmune (immune-mediated) diseases include rheumatoid arthritis, graft versus host disease, systemic lupus erythematosus (SLE), scleroderma, multiple sclerosis, diabetes, organ rejection, inflammatory bowel disease, psoriasis, and other afflictions. It is becoming increasingly apparent that many vascular disorders, including atherosclerotic forms of such disorders, have an autoimmune component, and a number of patients with vascular disease have circulating auto antibodies. Autoimmune diseases may be divided into two general types, namely systemic autoimmune diseases (exemplified by arthritis, lupus and scleroderma), and organ-specific (exemplified by multiple sclerosis, diabetes and atherosclerosis, in which latter case the vasculature is regarded as a specific organ).

In general terms, a normally functioning immune system distinguishes between the antigens of foreign invading organisms (non-self) and tissues native to its own body (self), so as to provide a defence against foreign organisms. Central to the proper functioning of the immune system, therefore, is the ability of the system to discriminate between self and non-self. When a patient's immune system fails to discriminate between self and non-self and starts to react against self antigens, then an autoimmune disorder may arise.

The causes responsible for the reaction of an affected person's immune system against self are not fully understood, and several different theories have been put forward. The immune response to an antigen is triggered by the interaction of the antigen with receptors of predetermined specificity on certain lymphocytes. It is believed that, at an early stage in development of the immune system, those lymphocytes with receptors recognizing self antigens are recognized and eliminated from the body's system by a process of deletion. Alternatively, or in addition, such self-reactive lymphocytes may be controlled by the suppression of their activities. Both mechanisms probably occur.

The immune system of normal healthy individuals is able to identify and to react against a family of proteins which are highly conserved in nature (i.e. they have a similar structure

throughout all living organisms). This family of proteins is called the stress or heat-shock proteins (HSP), and they are grouped according to their approximate molecular weights. Members of the HSP family include the HSP60 group, including, among others, proteins in the molecular weight range 50 to 100 kilodaltons. Increased production of HSP's was first identified as a response to heat stress, but this now appears to be part of a general response to a variety of cell stresses. HSPs are normally located within cells, and their function appears to be stabilization of the structure of various proteins in stressed cells, so as to protect the cell from the protein denaturing effects of various stressors. However, it is likely that HSPs have a number of other functions which are, as yet, not fully understood. Heat shock proteins, HSP's are discussed in some detail by William J. Welch, in an article in "Scientific American", May, 1993, page 56.

One group of the family of HSP's, the HSP60 group, contains proteins which show about 50% identity between bacterial cells and human cells. Infections with bacteria containing HSP 65 results in an immune response in healthy humans against the bacterial HSP65, evidenced by the production of anti-HSP65 antibodies. Thus, a healthy immune system appears to be able to identify and react against self-like antigens.

In certain pathologies, for example many autoimmune diseases such as rheumatoid arthritis and scleroderma, patients also show the presence of antibodies to HSP65. In the past, this has led to conclusions that autoimmune diseases result from bacterial infection. Now it seems likely that autoimmune diseases are associated with an inappropriate control of autoimmune response. In other words, it is possible that the antibodies to HSP65 result from an autoimmune reaction initiated by HSPs from the body itself, but one which has been improperly controlled. In such cases, therefore, it should be possible to control an inappropriate autoimmune response, by stimulating the body's natural immune control mechanisms, using a particularly and specific method of vaccination.

To stimulate the body's immune response, a vaccine is required which will, upon injection into the host body, enable the host immune system to present the antigens contained in the vaccine to cells of the host immune system. Antigen presentation is performed by antigen presenting cells.

A vaccine to treat autoimmune diseases should contain antigens or fragments thereof (peptides) that will activate the body's immune control mechanisms present. In addition, the antigens (peptides) should be present in a form which can be recognized by the host immune system when the vaccine is introduced into the host. Certain of the antigens may be present on intact cells. The objective of such a vaccination is to activate regulatory immune pathways, particularly those controlling autoimmune responses, thereby downregulating the autoimmune response.

The particular antigens which will activate the control mechanisms of a mammalian autoimmune system are not fully understood. It is however recognized that they may include antigens derived from lymphocyte receptors, which may function to stimulate control mechanisms, to inhibit those lymphocytes which cause pathological autoimmune responses in the patient. They may also include HSPs, such as the HSP60 group of proteins, and leucocyte surface molecules such as those of the Major Histocompatibility Complex (MHC) including MHC Class II molecules. MHC Class II molecules function physiologically to present peptides to CD4<sup>+</sup>T-cells as part of the immune response.

It is important that the lymphocyte receptors and other cell-derived molecules for vaccination of an autoimmune suffering patient be derived from cells obtained from the same patient, since this system will contain the autoimmune specificity. Receptors on other leucocytes in the blood may alternatively or additionally be important in a proposed vaccination process. The use of such a system as the basis of a vaccine may be considered analogous to the use of a particular viral antigen as a vaccine to treat and prevent disease caused by that virus. A vaccine for treating an autoimmune disease should, therefore, be prepared from a sample of the patient's own blood. Such a vaccine may be described as an autovaccine.

For antigens to be effective in stimulating (or inhibiting) the immune system, the antigens should be presented to immune cells of the host system by antigen-presenting cells, which are naturally present in the body. Many of the antigen-presenting cells are phagocytes, which attach to the antigens, engulf them by phagocytosis, and break them down or process them. The preparation of such an autovaccine should include a process whereby the lymphocytes and other leucocytes in the vaccine, which may be a source of antigens, are modified into a form whereby they are likely to be phagocytosed by phagocytic antigen-presenting cells upon re-injection into the patient, so that the antigens or effective residues thereof are presented on the surface of an antigen-presenting cell. Then they can effect a controlling mechanism on the immune system, either inhibitory or stimulatory.

During the normal growth period of a mammalian body, tissues become reshaped with areas of cells being removed. This is accomplished by the cells' undergoing a process called programmed cell death or apoptosis, the apoptotic cells being phagocytosed while not becoming disrupted sufficient to expose self-antigens to the immune system.

#### BRIEF REFERENCE TO THE PRIOR ART

U.S. Pat. No. 3,715,430 Ryan relates to a method and apparatus for producing substantially pure oxygen having a controlled content of ozone and higher oxygen polymers. The purified oxygen gas is exposed to ultraviolet light in a wavelength of 2485 to 2537 angstrom units in order to produce 5 to 500 parts per million of ozone and higher oxygen polymers in the gas mixture. Ryan indicates that the gas produced in this manner is non-irritating to the human body and may be intravenously injected into the blood stream for therapeutic use.

U.S. Pat. No. 4,632,980 Zee et al. discloses a method of freeing blood and blood components of enveloped viruses by contacting the blood or blood product in an aqueous medium with an enveloped virus inactivating amount of ozone. The treatment is carried out at a temperature of 4° to 37° C., and an ozone concentration of 1-100 ppm.

U.S. Pat. No. 4,831,268 Fisch et al. provides a method for the radiation of blood to prevent arteriosclerosis related heart and vascular diseases caused by disturbances in the fat exchange. The disclosed process involves irradiating the blood in a blood conducting tube with radiation having an intensity of from about 1 mWcm<sup>-2</sup> to 10 mWcm<sup>-2</sup> in a wavelength range of from about 300 to 600 nm.

U.S. Pat. No. 4,968,483 Müller et al. describes an apparatus for oxygenating blood, by treating an aliquot of a patient's blood, extracorporeally, with an oxygen/ozone mixture and ultraviolet light, at a controlled temperature. The apparatus is proposed for use in haematological oxidation therapy.

U.S. Pat. No. 5,052,382 Wainwright discloses an apparatus for the controlled generation and administration of ozone. The apparatus includes a generator for generating ozone, a monitor for monitoring the ozone production, a dosage device for providing a predetermined amount of ozone administration, and a computer control device for controlling the operation of the apparatus. The patent further discloses that administration of ozone to patients is known for the treatment of viral and bacterial infections, as well as for the treatment of external sores and wounds.

#### SUMMARY OF THE INVENTION

It is an object of the present invention to provide a novel autovaccine useful in the prevention and alleviation of symptoms of atherosclerosis.

It is a further object of the present invention to provide a novel process for the preparation of such an autovaccine.

It is a further and more specific object of the present invention to provide a novel method for prevention and alleviation of the symptoms of atherosclerosis in a mammalian subject, preferably a human subject.

Accordingly, the present invention provides, from a first aspect, an autovaccine for prevention and treatment of atherosclerosis in a mammalian subject, and derived from an aliquot of the subject's own blood. The autovaccine is characterized by the presence therein, in comparison with the normal blood of the patient, of at least one of the following characterizing features:

- increasing numbers of lymphocytes and other leucocytes, exhibiting a condensed apoptotic-like morphology;
- a release of specific proteins from the cell surface of the blood leucocytes, including the MHC Class II molecule HLA-DR, resulting in a reduction in the number of cells expressing such surface proteins;
- an upregulation in the expression of certain cell surface markers for example CD-11a, a component of the ligand for the cell adhesion molecule ICAM-1; and certain T-cell regulatory molecules;
- an increase in the amount of heat shock protein HSP-60 in the plasma;
- a decrease in HSP-72 within the lymphocytes.

By inducing an apoptotic-like state in the lymphocytes and other leucocytes in the blood comprising the autovaccine, as evidenced by the increased numbers of lymphocytes and other leucocytes exhibiting a condensed apoptotic-like morphology therein, these cells may become more readily phagocytosed upon re-injection into the host body.

There are a number of different phagocytic cell types present in the mammalian body, including various antigen presenting cells and neutrophils. In order to facilitate phagocytosis by antigen presenting cells rather than by other phagocytes, the lymphocytes and other leucocytes present in the autovaccine of the invention are treated so that they may interact preferentially with antigen presenting phagocytic cells. Cells adhere to each other by a number of mechanisms including the expression of cell adhesion molecules. Cell adhesion molecules present on one cell type interact with specific ligand for particular adhesion molecules present on the adhering cell type. The present invention may result in a preferential interaction of cells in the autovaccine to antigen presenting cells in the host body, by upregulation, on the surface of the cells in the autovaccine, of the expression of the ligand for adhesion molecules found on antigen-presenting cells in the host body. Antigen-presenting cells

express a number of cell adhesion molecules, including ICAM-1, a component of the ligand of which is CD-11a. One way by which the process of the invention may change the preferential phagocytosis of apoptosing cells is by upregulation of CD-11a.

The preparation of the autovaccine according to the present invention comprises extracting from the subject an aliquot of blood of volume about 0.01 ml to about 400 ml, and contacting the aliquot of blood, extracorporeally, with an immune system-stimulating effective amount of ozone gas and ultraviolet radiation.

The method for preventing and alleviating the symptoms of atherosclerosis in a human subject, in accordance with the present invention, comprises extracting from the patient an aliquot of blood of volume about 0.001 ml to about 400 ml, contacting the aliquot of blood, extracorporeally, with an immune system-stimulating amount of ozone gas and ultraviolet radiation, followed by administering the treated blood aliquot to the subject.

In another aspect, the present invention provides a method of treating or preventing atherosclerosis in a mammalian subject, comprising: (a) extracting an aliquot of blood from the subject; (b) treating the aliquot of blood *ex vivo* with at least one stressor selected from the group consisting of an oxidizing agent, ultraviolet radiation and elevated temperature; and (c) administering the aliquot of blood treated in step (b) to the subject.

#### BRIEF DESCRIPTION OF THE DRAWINGS

The patent file contains at least one drawing executed in color. Copies of this patent with the color drawing(s) will be provided by the Office upon request and payment of the necessary fee.

The accompanying drawing

FIG. 1 shows scanning electron micrographs of peripheral blood mononuclear cells isolated from whole blood by density gradient centrifugation, the micrograph labeled (A) showing mononuclear cells obtained from an untreated blood sample, and the micrograph labeled (B) showing mononuclear cells obtained from a sample of blood treated according to the method of the present invention;

FIG. 2 is a graphical presentation of the results of Example 2 below;

FIG. 3 comprises photographs of two full length aortae obtained from LDL receptor deficient mice which underwent the study described in Example 5, the aorta labeled 1 being obtained from an animal which received a high cholesterol diet and sham treatments, and the aorta labeled 2 being obtained from an animal which received a high cholesterol diet and was treated according to a preferred method of the present invention, with aortic lipid deposition being made visible by staining the aortae with oil red O; and

FIGS. 4 to 6 comprise photographs of aortic cross-sections obtained from LDL receptor deficient mice which underwent the study described in Example 5, the aorta shown in FIG. 4 being obtained from an animal which received a normal diet, the aorta of FIG. 5 being obtained from an animal which received the high cholesterol diet and sham treatments, and the aorta of FIG. 6 being obtained from an animal which received a high cholesterol diet and was treated according to a preferred method of the present invention, with the presence of macrophages in the aortic plaque deposits being made visible by immunostaining the aortae.

#### DESCRIPTION OF THE PREFERRED EMBODIMENTS

When the autovaccine according to the present invention is injected into the autoimmune patient, significant allevia-

tion of the patient's autoimmune condition is experienced, as set out in the specific embodiments of the invention described below. Exactly how the vaccine operates following this re-injection is not currently fully understood. The following tentative explanations are offered for a better and more complete description of the invention, but are not to be considered as binding or limiting.

T-cells, which are one kind of lymphocyte and which play a significant role in the control of the immune system, include CD-8 cells, and CD-4 cells otherwise known as T-helper cells, further subdividable into TH1 and TH2 cells. The TH1 cells secrete pro-inflammatory cytokines such as interferon gamma. The TH2 cells are considered to be regulatory cells and secrete regulatory cytokines, such as interleukin-4. In a normal, healthy individual, the ratio of TH1 cells to TH2 cells is around 3:1. In autoimmune conditions, there is usually an imbalance in the TH cell types, often with an increase in the TH1 cells compared to the TH2 cells, i.e. there is a change in the ratio between them, with a consequent development of an inflammatory condition often noted in autoimmune disease. A number of components of the autovaccine of the present invention, possibly including HLA-DR and/or other MHC antigens released from the leucocyte cell surfaces, upregulate the TH2 cells in the patient's blood and/or locally at the site of the inflammation, thereby increasing the secretion of regulatory cytokines, and/or upregulating the suppressor cells to stimulate an inhibitory pathway for the autoimmune disease and alleviate or even switch off the autoimmune response pathway.

It is also commonly accepted that autoimmune disease sufferers may have significant populations of abnormal autoreactive T-cells, which are partly responsible for the autoimmune disease. The autoimmune disease suffering patient's ability to suppress these autoreactive T-cells is compromised. The autovaccine of the invention restores the system towards a normal immune state.

The autovaccine is prepared by exposing the blood aliquot to at least one stressor, in controlled amounts, the stressor being selected from among oxidizing agents such as ozone, ultraviolet radiation and elevated temperature, and combinations of two or more of such stressors. The resulting blood aliquot, after such treatment, serves as an autovaccine, and can be re-injected into the autoimmune patient. Following a course of such treatments, a patient's signs and symptoms of autoimmune disease such as those of rheumatoid arthritis, scleroderma and the like are markedly reduced. The subjective reports of alleviation of symptoms of rheumatoid arthritis are consistent with objective measurements of relative erythrocyte sedimentation rates, an objective test accepted as meaningful in measuring the progression of an autoimmune disease such as rheumatoid arthritis, by the American College of Rheumatology.

In preparing the autovaccine according to the invention, by modification of a blood aliquot extracted from the patient, the blood cells are stressed. This affects the heat shock proteins, HSP, contained in the cell. HSP-60 levels in the mononuclear cells are reduced, and are increased in the plasma. Further, the level of HSP-72 present in the mononuclear cells is reduced. Also as a result of the process of the invention, certain surface (membrane) proteins on the lymphocytes, for example HLA-DR, are reduced whereas others, such as CD-3, do not change and yet others such as CD-11a in neutrophils are upregulated. Accordingly it is apparently not a non-specific membrane change which is occurring, nor is it cell destruction. It is a complex active process.

On microscopic visualization of the autovaccine according to the present invention, mononuclear cells with a condensed apoptotic-like morphology can be observed, suggesting the presence in the autovaccine of increased numbers of apoptosing cells capable of preferential phagocytosis upon reinjection, for appropriate presentation of the antigens of the autoimmune disease. The effect of the treatment of the present invention on the morphology of blood mononuclear cells is illustrated in FIG. 1, which shows scanning electron micrographs of (A) mononuclear cells from untreated blood and (B) mononuclear cells from blood treated according to the method of the invention. The blood cells were isolated from whole blood by density gradient centrifugation and observed under scanning electron microscopy.

In the preferred autovaccine in accordance with the present invention, the number of mononuclear cells or leucocytes exhibiting the presence of HSP-60 therein is decreased, as does the amount of HSP-60 in each cell, as compared with the normal, untreated peripheral blood of the source patient. Whereas the patient normally has, typically, about 30% of mononuclear cells exhibiting the presence of HSP-60 therein (as measured by whole blood intracellular flow cytometry), the autovaccine has only 12–20%. In clinical studies, it has been found that the figure reduces from 29.3% to 15.5%, mean of six tests. Preferably also, the number of leucocytes exhibiting the presence of HSP-72, which is about 50% in the untreated blood of the source patient, is reduced to 25–35% in the autovaccine of the present invention. In clinical studies, this figure for HSP-72 reduced from 49.4% in untreated blood to 30.2% in the autovaccine, mean of six tests, similarly measured.

The number of cells which express the cell surface specific protein HLA-DR, in the preferred autovaccine of the present invention, is reduced as compared with the patient's untreated blood, possibly as a result of its release from the cell surface. Typically, the number of cells expressing HLA-DR reduces from about 23% to about 8–12%, as measured by whole blood flow cytometry. In clinical studies, this figure reduced from 23.3% to 10.3%, mean of five experiments.

The upregulation of the surface marker CD-11a in the preferred autovaccine of the present invention can be expressed as an increase in the percentage of neutrophils in the autovaccine which test positive for CD-11a, compared with the patient's source blood. Typically, the increase is from about 10% up to the approximate range 70–95%. In clinical studies, an increase from 10.3% to 84% was obtained, mean of six tests.

A significant feature of the present invention is that the source of the blood from which the autovaccine is prepared for a specific patient suffering from an autoimmune disease is the patient himself or herself. The antigens forming the basis of the autovaccine find their origin in the patient's own blood. No extraneous antigens are added; the effective antigens are present in the patient's blood, and/or are released or modified by the process of preparing the autovaccine using the patient's own blood as the source material. Moreover, in many cases, the precise autoimmune disease from which the patient suffers appears to be immaterial. The antigens for the autovaccine for the disease are present in, or are developed by treatment of, the patient's own blood.

Preferably, the stressors to which the leucocytes in the extracted blood aliquot are subjected are a temperature stress (blood temperature above body temperature), an oxidative environment, such as a mixture of ozone and oxygen bubbled through the blood aliquot, and ultraviolet radiation, simultaneously or successively, but preferably simultaneously.

The present invention provides a method of preventing and alleviating the symptoms of an autoimmune disease in a human, specifically atherosclerosis, which comprises:

(a) contacting of about 0.01 ml to about 400 ml of blood with an immune system modifying effective amount of ozone gas and ultraviolet radiation; and

(b) administering the blood treated in step (a) to a human.

In another aspect, the present invention provides a method of treating or preventing atherosclerosis in a mammalian subject, comprising: (a) extracting an aliquot of blood from the subject; (b) treating the aliquot of blood *ex vivo* with at least one stressor selected from the group consisting of an oxidizing agent, ultraviolet radiation and elevated temperature; and (c) administering the aliquot of blood treated in step (b) to the subject.

In general, from about 0.01 ml to about 400 ml of blood may be treated according to the invention. Preferred amounts are in the range of about 0.1 ml to 200 ml. More suitably, the aliquot for treatment has a volume of from about 0.1–100 mls, preferably 1–50 ml and most preferably 5–15 mls. The method most preferably involves treating an aliquot of about 10 mls of blood with ozone gas and ultraviolet radiation, then re-administering the treated blood to the patient by intramuscular injection.

As noted, it is preferred, according to the invention, to apply all three of the aforementioned stressors simultaneously to the aliquot under treatment. Cure must be taken not to utilize an excessive level of the stressors, to the extent that the cell membranes of the white cells are caused to be disrupted.

The temperature stressor must keep the aliquot in the liquid phase, i.e. from about 0° C. to about 56° C. and should not heat it above about 55° C. Any suitable source of heat known in the art may be employed to heat the blood, preferably one or more infrared lamps. Preferably the temperature stressor warms the aliquot being treated, to a temperature above normal body temperature, i.e. to about 37–55° C., and most preferably from about 37–43° C., e.g. about 42.5° C. Preferably the temperature of the blood aliquot is maintained at this elevated temperature during the treatment with UV/ozone.

Alternatively, the blood sample is heated while being subjected to UV radiation, until the blood reaches a predetermined temperature (preferably about 42.5° C.), at which point bubbling of ozone gas through the blood is commenced. The concurrent UV/ozone treatment is then maintained for a predetermined period of time, preferably about 3 minutes.

Another alternative method involved subjecting the blood to UV/ozone while heating to a predetermined temperature (preferably about 42.5° C.), then either ending the treatment once the predetermined temperature is reached, or continuing UV/ozone treatment for a further period of time, most preferably about 3 minutes.

The application of the oxidative stressor preferably involves exposing the aliquot to a mixture of medical grade oxygen and ozone gas, most preferably by bubbling through the aliquot, at the aforementioned temperature range, a stream of medical grade oxygen gas having ozone as a minor component therein. The ozone gas may be provided by any conventional source known in the art. Suitably the gas stream has an ozone content of from 0.5–100 µg/ml, or about 1.0–100 µg/ml, preferably 3–70 µg/ml, and most preferably from about 5–50 µg/ml. The gas stream is supplied to the aliquot at a rate of from about 0.01–2.0 liters per minute, preferably 0.1–1.0 liters per minute and most preferably at about 0.12 liters per minute (STP).

The ultraviolet radiation stressor is suitably applied by irradiating the aliquot under treatment from an appropriate source of UV radiation, while the aliquot is maintained at the aforementioned temperature and while the oxygen/ozone gaseous mixture is being bubbled through the aliquot. The ultraviolet radiation may be provided by any conventional source known in the art, for example by a plurality of low-pressure ultraviolet lamps. The method of the invention preferably utilizes a standard UV-C source of ultraviolet radiation, namely UV lamps emitting in the C-band wavelengths, i.e. at wavelengths shorter than about 280 nm. Ultraviolet radiation corresponding to standard UV-A and UV-B sources can also be used. Preferably employed are low-pressure ultraviolet lamps that generate a line spectrum wherein at least 90% of the radiation has a wavelength of about 253.7 nm. An appropriate dosage of such UV radiation, applied simultaneously with the aforementioned temperature and oxidative environment stressors, is obtained from lamps with a power output of from about 15 to about 25 watts, at the chosen UV wavelength, arranged to surround the sample container holding the aliquot, each lamp providing an intensity, at a distance of 1 meter, of from about 45–65 mW/sq.cm. Several such lamps surrounding the sample bottle, with a combined output at 253.7 nm of 15–25 watts, operated at maximum intensity, may advantageously be used. At the incident surface of the blood, the UV energy supplied is 0.2–0.25 Joules per cm<sup>2</sup>. Such a treatment provides a blood aliquot which is appropriately modified according to the invention to create the autovaccine outlined above ready for re-injection into the patient.

The time for which the aliquot is subjected to the stressors can be from a few seconds to about 60 minutes. It is normally within the time range of from about 0.5–60 minutes. This depends to some extent upon the chosen intensity of the UV irradiation, the temperature and the concentration of the rate at which the oxidizing agent is supplied to the aliquot. The more severe the stressors applied to the aliquot, generally the shorter time for which they need to be applied. Some experimentation to establish optimum times may be necessary on the part of the operator, once the other stressor levels have been set. Under most stressor conditions, preferred times will be in the approximate range of about 0.5–10 minutes, most preferably 2–5 minutes, and normally around 3 minutes. The starting blood temperature, and the rate at which it can be warmed or cooled to a predetermined temperature, tends to vary from patient to patient.

In the practice of the preferred process of the present invention, the blood aliquot (or the separated cellular fractions of the blood, or mixtures of the separated cells, including platelets, these various leucocyte-containing combinations, along with whole blood, being referred to collectively throughout as the "aliquot") may be treated with the stressors using an apparatus of the type described in U.S. Pat. No. 4,968,483 Mueller. The aliquot is placed in a suitable, sterile, UV-radiation-transmissive container, which is then fitted into the machine. The temperature of the aliquot is adjusted to the predetermined value, e.g. 42.5° C., by the use of a suitable heat source such as an IR lamp, and the UV lamps are switched on for a fixed period before the gas flow is applied to the aliquot providing the oxidative stress, to allow the output of the UV lamps to stabilize. Then the oxygen/ozone gas mixture, of known composition and controlled flow rate, is applied to the aliquot, for the predetermined duration of 0.5–60 minutes preferably 2–5 minutes and most preferably about 3 minutes as discussed above, so that the aliquot experiences all three stressors simultaneously. In this way, the blood aliquot is appropriately

modified to produce an autovaccine according to the present invention sufficient to achieve the desired effects.

Example 4 below supports the finding that the method of treating blood according to the invention has an immune modifying effect. In particular, treatment of blood with UV/ozone has been found to increase the expression of activation markers on the surface of the lymphocytes.

Thus, the invention also provides a method of stimulating or activating the immune system in a human by contacting about 0.01 ml to about 400 ml of blood from a human with an immune system-stimulating effect amount of ozone gas and ultraviolet radiation, followed by administering the treated blood to a human. It is believed that this stimulation or activation of the immune system may have the effect of preventing and alleviating atherosclerosis. Similarly, the invention contemplates a method of treating an existing immune system disorder in a human, in particular atherosclerosis, by contacting about 0.01 ml to about 400 ml of blood from a human with an immune system-stimulating effective amount of ozone gas and ultraviolet radiation, followed by administering the treated blood to a human.

The immune system disorders which may be treated by this method include allergic conditions, autoimmune conditions, and inflammatory conditions. Specific immune system disorders which may be treated according to the invention include rheumatoid arthritis, scleroderma, diabetes mellitus, organ rejection, miscarriage, multiple sclerosis, inflammatory bowel disease, psoriasis, and other inflammatory disorders. The discoveries of the present invention may also be applied to treat autoimmune diseases which manifest as infertility, including endometriosis. It is also effective in treatment of atherosclerosis, which can be regarded as an autoimmune disease of the vasculature.

The invention is further described for illustrative purposes with reference to specific examples of pre-clinical and clinical use of it and objective and subjective results from such uses.

## SPECIFIC DESCRIPTION OF THE MOST PREFERRED EMBODIMENTS

### EXAMPLE 1

Thirty patients with active rheumatoid arthritis, 21 females and 9 males, were treated by the preferred process according to the present invention. The age range of the patients was 26–72 years, with the mean age 52.2 years, at the start of the study. Each patient received between 30 and 60 individual treatments (mean 48.3 treatments) over a time span of 62 weeks (mean 20.6 weeks). Each individual treatment consisted of the removal of 10 a mL aliquot of blood, the treatment of the blood aliquot simultaneously with gaseous oxygen/ozone mixture and ultraviolet light at elevated temperature using an apparatus as generally described in the aforementioned U.S. Pat. No. 4,968,483 Mueller et al.

The constitution of the gas mixture was 14–15 mcg/mL ozone/medical grade oxygen. The gas mixture was led through the aliquot at a rate of about 200 mLs/minute, for a period of 3 minutes. The temperature of the aliquot was held steady at 42.5° C. The UV radiation has a wavelength of 253.7 nm.

Post treatment measurements were conducted 1 day to nine months after the final treatment of each patient (mean 12.4 weeks). Blood samples were taken and analyzed for leucocytes, erythrocyte sedimentation rate, rheumatoid factor and C-reactive protein, using standard test procedures. The erythrocyte sedimentation rate and C-reactive protein

are elevated in most inflammatory conditions including rheumatoid arthritis, and Rheumatoid Factor is elevated in most cases of rheumatoid arthritis as well as in some cases of certain other autoimmune diseases. White blood cell count, erythrocyte sedimentation rate, rheumatoid factor and C-reactive protein all showed significant reduction after the course of treatment. Particularly noteworthy is the significant reduction in erythrocyte sedimentation rate, an indicator of rheumatoid arthritis improvement, accepted by the American College of Rheumatology.

In addition, patients were rated by medical personnel subjectively, for the apparent severity of their rheumatoid arthritis symptoms, before and after the courses of treatment, on a scale of 5 (very bad) to 1 (excellent). Again, a marked improvement in each case was reported.

The mean results are given in Table 1 below.

TABLE 1

Clinical Measurements	Normal Ranges	Pre-Treatment (Mean ± SD)	Post-Treatment (Mean ± SD)	Paired T-Test
Symptom Rating		3.9 ± 0.9	2.6 ± 0.6	p<0.0001
Leucocytes, 10 <sup>9</sup> /L	4.0~10.0	11.68 ± 2.81	8.70 ± 1.02	p<0.0001
Erythrocyte Sed. Rate 1 hr (mm)	0~20	50.1 ± 22.9	28.1 ± 13.7	p<0.0001
Rheumatoid Factor IU	<100	117.0 ± 76.1	91.7 ± 67.4	p<0.02
C-Reactive Protein mg/L	<1.0	5.28 ± 3.62	3.73 ± 3.44	p<0.009

EXAMPLE 2

Four patients with primary Raynaud's disease were given a course of therapy according to the invention, in an open clinical trial performed at St Bartholomew's Hospital, London, under properly controlled and supervised conditions. All four patients showed alleviation of their symptoms following treatment.

An investigation of an autoimmune component of the disease in these patients demonstrated high levels of auto-antibodies specific for HSP-60 and HSP-65 in one patient. The levels of these auto-antibodies in this patient are shown on FIG. 2, from which it can be seen that the levels decreased markedly following a course of therapy. The first course of treatment, indicated "1" on FIG. 2, consisted of 9 treatments carried out over 14 days. Furthermore, the levels of these auto-antibodies began to increase again some weeks later, and were again lowered following a second course of therapy. The second course of treatment, indicated "2" on FIG. 2, consisted of 5 treatments carried out over 10 days. These data suggest that therapy with blood treated according to the invention, i.e. the autovaccine described herein, may reduce an autoimmune response as evidenced by a reduction of auto-antibodies in a treated patient.

EXAMPLE 3

The helper T-lymphocyte subsets TH1 and TH2 have been measured in 13 normal control volunteers and in two patients suffering from the autoimmune disease scleroderma. The ratio of TH1:TH2 in the controls, as measured by intracellular cytokine flow cytometry, was found to be 3.029+/-0.639 (mean+/-standard deviation). The patients with scleroderma had TH1:TH2 ratios of 5.0 and 4.58 respectively, most likely, indicating an increase in the TH1

population relative to the TH2 population. In inflammatory pathologies such as many autoimmune diseases there is a relative increase in the TH1 cells; therefore it was to be expected that this ratio would be higher in these patients than in the healthy control individuals.

Following a course of therapy with blood treated according to the invention (i.e. the autovaccine described herein), the TH1:TH2 ratios in these patients was 3.29 and 3.13 respectively, i.e. the ratio had approached the normal range. These data suggest that therapy with blood treated according to the present invention may reduce an autoimmune response as evidenced by a relative increase in the TH2 cells.

EXAMPLE 4

15 Staining of Activation Markers

This example illustrates an experimental approach which indicates that treatment of blood with UV/ozone according to the invention has an immune-stimulatory effect on human blood, as evidenced by an increase in certain activation markers on the surface of the treated mononuclear cells.

Samples (20 ml) of peripheral blood were taken from individuals. Each sample was divided into two aliquots. The first aliquot was treated according to the inventive technique, as follows:

25 The 10 ml aliquot was treated in vivo for three minutes with ozone gas (variable ozone concentration of 5.50 µg/ml) and ultraviolet light (253.7 nm), at a temperature of 42.5° C. An apparatus similar to that disclosed in U.S. Pat. No. 4,968,483 was utilized to carry out the treatment of the blood sample.

30 The second 10 ml aliquot from each sample served as an untreated control.

Each blood sample was stained for certain activation markers of T-lymphocytes using conventional monoclonal antibody techniques. The proportion of the total cells which stained positive for the individual markers was quantitated by microscopy. The results are shown in Table 2 below.

TABLE 2

Marker	Control	Ozone/UV Treated
CD25 (IL-2 receptor)	1%	26%
CD2 (E-rosette receptor)	3%	33%

45 The above data for this example are all means of duplicates, and indicate that treatment with UV/ozone according to the invention results in the activation of T-lymphocytes.

EXAMPLE 5

50 Model

The purpose of the experiment is to determine the effects of treatment according the present invention on the development of atherosclerosis in the LDL receptor (LDL-R) deficient mouse model, a widely used transgenic atherosclerosis model created by targeted disruption of the LDL receptor. This animal model is analogous to familial hypercholesterolemia, an inherited condition in which a mutation results in complete lack of functional LDL-R. In the human disease, homozygous individuals demonstrate a marked increase in serum cholesterol and develop severe premature atherosclerosis, often succumbing to this disease at an early age. In patients with this disease, currently used lipid lowering agents do not have a significant effect in terms of lowering cholesterol levels.

65 The LDL-R deficient mouse model shows intolerance to cholesterol feeding and develops widespread atherosclerotic

changes which progress to mature fibrous lesions morphologically indistinguishable from established human atherosclerosis. Apart from the defined genetic abnormality causing predisposition to atherosclerosis, this model has the advantage of rapid development of widespread atherosclerosis within 6 to 8 weeks following institution of cholesterol feeding.

#### Protocol

LDL-R deficient mice were purchased from Jackson Laboratories. A total of 20 mice were entered into the study at 22 weeks of age, and 15 mice completed the study. The length of the study was 8 weeks. The mice were maintained on a 12 hour dark/12 hour light cycle with free access to food and water, and were fed a specified diet as follows. A control group comprised of 5 animals, all of which completed the study, received a normal diet. The high cholesterol group comprising 15 animals, of which 10 completed the study, were fed a diet containing 1.25% cholesterol, 7.5% cocoa butter, 7.5% casein, and 0.5% sodium cholate. To ensure proper food intake, food consumption and animal weight were monitored on a weekly basis. In previous experiments, it was demonstrated that 8 weeks of feeding with the high cholesterol diet results in substantial atherosclerosis development, particularly in the aortic arch and the descending thoracic aorta.

#### Treatment

Ten of the animals fed the high cholesterol diet were selected at random to undergo a course of treatment by the preferred method of the invention. Six of the treated animals completed the study. It is to be noted that the four deaths in this group were not in any way related to the treatment, but occurred early in the study as a result of fighting among animals which were housed together during the study. The other five animals on the high cholesterol diet underwent a course of sham treatments, and four survived the protocol.

The treatments began four weeks after initiation of the study, with each of the animals on the high cholesterol diet receiving a total of 10 treatments (2 courses of treatment of 1 injection per day for 5 days, the 2 courses of treatment separated by two days, i.e. 10 injections over a period of 12 days). Each individual treatment administered to the animals treated by the method of the present invention consisted of the collection of 10 ml of blood from genetically compatible donor animals fed on a normal diet, the blood being collected into sodium citrate anticoagulant. In order to collect each 10 ml aliquot of blood, about 1 ml of blood was extracted from each of 10 animals. The blood was extracted by cardiac puncture, with the animals being under full xylazine/ketamine anesthesia during the blood extraction procedure, and being given T-61 immediately following extraction. The blood aliquot was transferred to a sterile, disposable, low-density polyethylene vessel for ex vivo treatment, and was then treated simultaneously with a gaseous oxygen/ozone mixture and ultraviolet light at elevated temperature using an apparatus as generally described in aforementioned U.S. Pat. No. 4,968,483 to Mueller et al.

The constitution of the gas mixture was  $14.5 \pm 1.0 \mu\text{g}$  ozone/ml, with the remainder of the mixture comprising medical grade oxygen. The gas mixture was bubbled through the aliquot at a rate of  $240 \pm 24$  ml/min for a period of 3 minutes. The temperature of the aliquot was held steady at  $42.5 \pm 1.0^\circ \text{C}$ . The UV light was within the UV-C band, and included a wavelength of 253.7 nm.

After treatment by the preferred method of the present invention,  $30 \mu\text{l}$  of the treated blood was re-injected intramuscularly into each animal undergoing treatment according to the present invention.

In the sham treatments,  $30 \mu\text{l}$  of untreated blood was injected intramuscularly into each of the remaining five animals on the high cholesterol diet.

#### Assessment of Atherosclerosis

After 8 weeks, the animals were anesthetized with zylaxine/ketamine and the heart was exposed. After nicking the vena cava to obtain blood samples, the animals were perfused via ventricular puncture, first with PBS to flush out the blood and then with 10% neutral buffered formalin for 3 minutes to fix the aorta. The thoracic aorta was dissected away from the thorax en bloc and stored in 10% formalin at  $4^\circ \text{C}$ . Pressure-fixed (10% formalin) aortae were removed en bloc and opened to allow a longitudinal full length inversion. The aortae were then mounted internally exposed on glass slides and stained with oil red O. The bright red staining (indicating lipid deposition) was then quantified using a computer assisted morphometric system, and expressed as a percentage of total aortic intimal surface.

#### Plasma Lipid and Lipoprotein Analysis

Lipoprotein profiles were obtained by means of fast-phase liquid chromatography with a Superose 6B column.  $200 \mu\text{l}$  aliquots of platelet-poor plasma from each animal were loaded onto the column and eluted with TSE buffer at a constant flow rate of 0.35 ml/min. An aliquot of  $80 \mu\text{l}$  from each fraction was used for the measurement of total cholesterol minus esterified cholesterol. Total cholesterol and triglycerides in plasma samples and column fractions for 11 representative animals were measured by an enzymatic method established in the lipid research group at St. Michael's Hospital, Toronto.

#### Statistical Analysis

Continuous variables are reported as mean  $\pm$  SD. Differences in cholesterol levels and triglyceride levels among groups were tested by student's t-test. Differences in atherosclerotic lesion area among groups were tested using the one-way ANOVA test in conjunction with the Bonferroni correction.

#### Results

FIG. 3 illustrates two full length aortae stained with oil red O to detect lipid deposition and plaque formation inside the arteries. The animals which received the high cholesterol diet and the sham treatments exhibited substantial aortic lipid deposition (aorta 1 in FIG. 3), with a ratio of atherosclerotic area (AA) to total area (TA) being  $0.16 \pm 0.1$ . In comparison, those animals which were treated by the preferred method of the present invention showed a profoundly reduced level of aortic lipid deposition (aorta 2 in FIG. 3), with AA/TA being  $0.04 \pm 0.02$ . These ratios are significantly different, with  $p < 0.05$ . In the animals which received the normal diet, no significant atherosclerotic changes were observed.

In addition, the animals which were treated according to the preferred method of the present invention were observed to have better general appearance, reduced skin xanthomatosis (eyelids, nose and paws), reduced limb swelling, and better appetite than the untreated animals which received the high cholesterol diet.

To further illustrate the effects of the method of the present invention, sections of aortae obtained from animals in this example were immunostained for MOMA-2, a marker of inflammatory monocyte/macrophages. These results are illustrated in FIGS. 4 (normal diet), 5 (HC diet-no treatment) and 6 (HC diet-treated). No staining is seen in FIG. 4. Staining is visible in both FIGS. 5 and 6, indicating that the majority of cells in the neointima of the animals which received the high cholesterol diet were monocyte/macrophages. However, as seen by comparing FIGS. 5 and



6, animals that had been treated by the method of the invention showed a marked reduction in the amount of plaque deposition, and therefore also show a decrease in the overall number of monocyte/macrophages. This indicates a reduction in autoimmune/inflammatory processes in the plaque of treated compared to control animals.

The measurement of the cholesterol levels among the different groups of animals showed that the total serum cholesterol level did not change significantly in the animals which received the normal diet, but was markedly increased in the animals receiving the high cholesterol diet. This marked increase occurred both in the sham treated group and to a lesser extent in the group which received the treatments according to the preferred method of the present invention.

The measured triglyceride levels were also higher in the animals which received the high cholesterol diet, as compared to the animals which received the normal diet. However, among the animals which received the high cholesterol diet, the increase in triglyceride levels was much greater in the sham treated group than in the group which was treated according to the preferred method of the present invention.

The measured cholesterol and triglyceride levels, and the average cholesterol and triglyceride levels for each group, are shown below in Table 3.

TABLE 3

GROUP	ANIMAL	CHOLESTEROL (mM)	TRIGLYCERIDES (mM)
Treated	1	12.99	0.305
Treated	2	13.39	0.336
Treated	3	16.22	0.348
Treated	4	14.87	0.397
	Average (1-4)	14.3 ± 1.5	0.35 ± 0.04
Control	6	4.41	0.341
Control	7	5.15	0.297
Control	8	5.73	0.440
	Average (6-8)	5.1 ± 0.7	0.39 ± 0.05
HC Diet	11	27.52	0.697
HC Diet	12	26.59	0.720
HC Diet	13	23.45	0.605
HC Diet	14	24.56	0.636
	Average (11-14)	25.5 ± 1.9	0.66 ± 0.05

In Table 3, the "Treated" group of animals received the high cholesterol diet and were treated according to the preferred method of the present invention, the "Control" animals received the normal diet and no treatment, and the "HC Diet" animals received the high cholesterol diet and the sham treatment.

EXAMPLE 6

In this study, LDL-R deficient mice were divided into groups and studied using the following protocol:

Group A (control)—fed a normal diet as in Example 5;

Group B1—fed a high cholesterol diet as described in Example 5 for 8 weeks;

Group B2—fed a high cholesterol diet as described in Example 5 for 12 weeks;

Group C1—fed a high cholesterol diet as described in Example 5 for 8 weeks, and treated by the preferred method of the present invention as described in Example 5 at 4 weeks of dietary intervention; and

Group C2—fed a high cholesterol diet as described in Example 5 for 12 weeks, and treated by the preferred method of the present invention as described in Example 5 at 8 weeks of dietary intervention.

For each group of animals, atherosclerotic area was assessed at either 8 or 12 weeks according to the method described in Example 5 under the heading "Assessment of Atherosclerosis". As demonstrated by measurement of atherosclerotic area, the animals of group B (high cholesterol diet alone) exhibited substantial aortic lipid deposition, with group B1 animals having levels of 0.16±0.1 at eight weeks and group B2 animals having levels of 0.17±0.1 at 12 weeks of dietary intervention. In contrast, the animals of group C (high cholesterol diet with treatment according to the invention) exhibited profoundly reduced lipid deposition, with group C1 animals having levels of 0.04±0.02 (p<0.05) at eight weeks of dietary intervention, and group C2 animals having levels of 0.04±0.02 (p<0.01) at twelve weeks of dietary intervention.

The animals of group C also exhibited a marked reduction in xanthelasma and limb swelling as compared to animals of group B.

Total lipoprotein profiles were measured as in Example 5 by fast-phase liquid chromatography and an enzyme-linked assay. The results of this analysis showed that the animals of group B (high cholesterol diet alone) had markedly increased levels of total serum cholesterol (CHO 46.71±3.61 mM) as compared to control group A (CHO 5.1±0.7 mM). The animals of group C did not show a significant reduction in cholesterol (CHO 44.69±2.83 mM; p=0.27 for B vs. C) as compared to the animals of group B.

As shown in above Examples 5 and 6, the treatment according to the present invention substantially inhibited the development of atherosclerosis in a mouse model of human familial hypercholesterolemia. In addition to substantially reducing the development of atherosclerosis at an early stage and inhibiting the progression of established atherosclerotic lesions, the treatment according to the preferred method of the present invention was shown to cause regression of existing atherosclerotic lesions. This can be seen for example by comparing the results for the animals of subgroups B1 and C2 in Example 6, which show that existing plaque deposits at week eight of a high cholesterol diet are reduced by about 75% when the animals are treated at week eight according to the present invention. These improvements in cardiovascular health were accompanied by improvements in the animals' general overall appearance and appetite.

Furthermore, Example 5 indicates that the method of the invention also achieved about a forty percent reduction in total serum cholesterol and a significant reduction in triglyceride levels. However, Example 6 demonstrates that the retardation in progression and regression of atherosclerotic plaques is not necessarily accompanied by a significant reduction in serum lipid levels.

As discussed above, atherosclerosis has a significant immune-modulated inflammatory component. It is therefore believed that the ability of the method of the invention to prevent and treat atherosclerosis is at least partially due to its anti-inflammatory action, and in particular its ability to produce an increase in the TH2 cells and/or a decrease in TH1 cells in the blood of treated subjects, as demonstrated in Example 3. As previously discussed, a relative increase in TH2 cells which secrete anti-inflammatory cytokines, relative to TH1 cells which secrete inflammatory cytokines, would be expected to reduce an autoimmune response.

Although the invention has been described with reference to specific preferred embodiments, it will be appreciated that many variations may be made to the invention without departing from the spirit or scope thereof. All such modifications are intended to be included within the scope of the following claims.

What is claimed is:

1. A method of inhibiting the development of atherosclerotic plaques in a mammalian subject, comprising:

- (a) identifying a subject in need of inhibiting the development of atherosclerotic plaques;
- (b) extracting an aliquot of blood from said subject;
- (c) modifying the extracted blood aliquot extracorporeally by subjecting it to about 0.5–100  $\mu\text{g}/\text{ml}$  of ozone gas and ultraviolet radiation at a temperature of from about 0° C. to about 56° C., so as to create in the blood aliquot, in comparison with an equal volume aliquot of the subject's unmodified blood, at least one of the following distinguishing features:
  - (i) increased numbers of leukocytes exhibiting a condensed apoptotic-like morphology;
  - (ii) a reduction in the number of leukocytes expressing the MHC Class II leukocyte cell surface specific protein HLA-DR;
  - (iii) an upregulated expression on leukocytes of the CD-11a cell surface marker;

and re-injecting the blood aliquot so modified into the subject, thereby inhibiting the development of atherosclerotic plaques in said subject.

2. The method of claim 1 wherein the aliquot size is from 0.01–400 ml.

3. The method of claim 2 wherein the aliquot size is from 1–50 ml.

4. The method of claim 1 wherein the ozone gas and ultraviolet radiation are applied to the blood aliquot simultaneously, whilst the blood aliquot is at a temperature of from 37–55° C.

5. The method of claim 1 wherein the ozone is administered as a gas stream in admixture with medical grade oxygen at a rate of from 0.01–2.0 liters per minute (STP), over a period of 0.5–60 minutes.

6. The method of claim 5 wherein the blood aliquot is treated with ozone and ultraviolet radiation at a temperature from 37–43° C., for a period of from 2–5 minutes, the ozone/oxygen mixture being supplied at a rate of from 0.1–1.0 liters per minute, with an ozone content of from 5–50  $\mu\text{g}/\text{ml}$ .

7. The method of claim 1 wherein the ultraviolet radiation is supplied from at least one ultraviolet lamp emitting in the C-band wavelength.

8. The method of claim 1 wherein the ultraviolet radiation is obtained from ultraviolet lamps emitting at least about 90% of ultraviolet radiation of a wavelength of about 253.7 nm.

9. The method of claim 1 wherein the extracted blood aliquot is extracorporeally treated so as to create in the subject, a decrease in the ratio of TH1:TH2 cells.

\* \* \* \* \*



US006258357B1

(12) **United States Patent**  
**Spaner**

(10) **Patent No.:** **US 6,258,357 B1**  
(45) **Date of Patent:** **Jul. 10, 2001**

(54) **INHIBITION OF GRAFT VERSUS HOST DISEASE**

(75) **Inventor:** **David Elliot Spaner, Toronto (CA)**

(73) **Assignee:** **Vasogen Ireland Limited, Shannon (IE)**

(\* ) **Notice:** Subject to any disclaimer, the term of this patent is extended or adjusted under 35 U.S.C. 154(b) by 0 days.

(21) **Appl. No.:** **09/363,678**

(22) **Filed:** **Jul. 30, 1999**

(30) **Foreign Application Priority Data**

Jul. 30, 1998 (CA) ..... 2244554

(51) **Int. Cl.<sup>7</sup>** ..... **A01N 63/00; A61K 45/00; A61K 47/00; A61K 39/00; A61L 2/00**

(52) **U.S. Cl.** ..... **424/93.71; 424/278.1; 424/613; 424/810; 422/24**

(58) **Field of Search** ..... **424/93.71, 278.1, 424/613, 810; 422/24**

(56) **References Cited**

**U.S. PATENT DOCUMENTS**

5,980,954 \* 11/1999 Bolton .

**FOREIGN PATENT DOCUMENTS**

96/37208 11/1996 (WO) .  
98/07436 2/1998 (WO) .

**OTHER PUBLICATIONS**

Spaner et al. Abstract 4272, Blood Nov. 15, 1998.

\* cited by examiner

*Primary Examiner*—Patrick J. Nolan

*Assistant Examiner*—Gerald R. Ewoldt

(74) *Attorney, Agent, or Firm*—Burns, Doane, Swecker & Mathis, LLP

(57) **ABSTRACT**

The development of graft versus host disease in a mammalian patient undergoing cell transplantation therapy for treatment of a bone marrow mediated disease, is prevented or alleviated by subjecting at least the T-cells of the allogeneic cell transplantation composition, extracorporeally, to oxidative stress, in appropriate dosage amounts, such as bubbling a gaseous mixture of ozone and oxygen through a suspension of the T-cells. The process may also include irradiation of the cells with UV light, simultaneously with the application of the oxidative stress. The oxidative stress induces reduced inflammatory cytokine production and a reduced proliferative response in the T-cells.

**7 Claims, 2 Drawing Sheets**

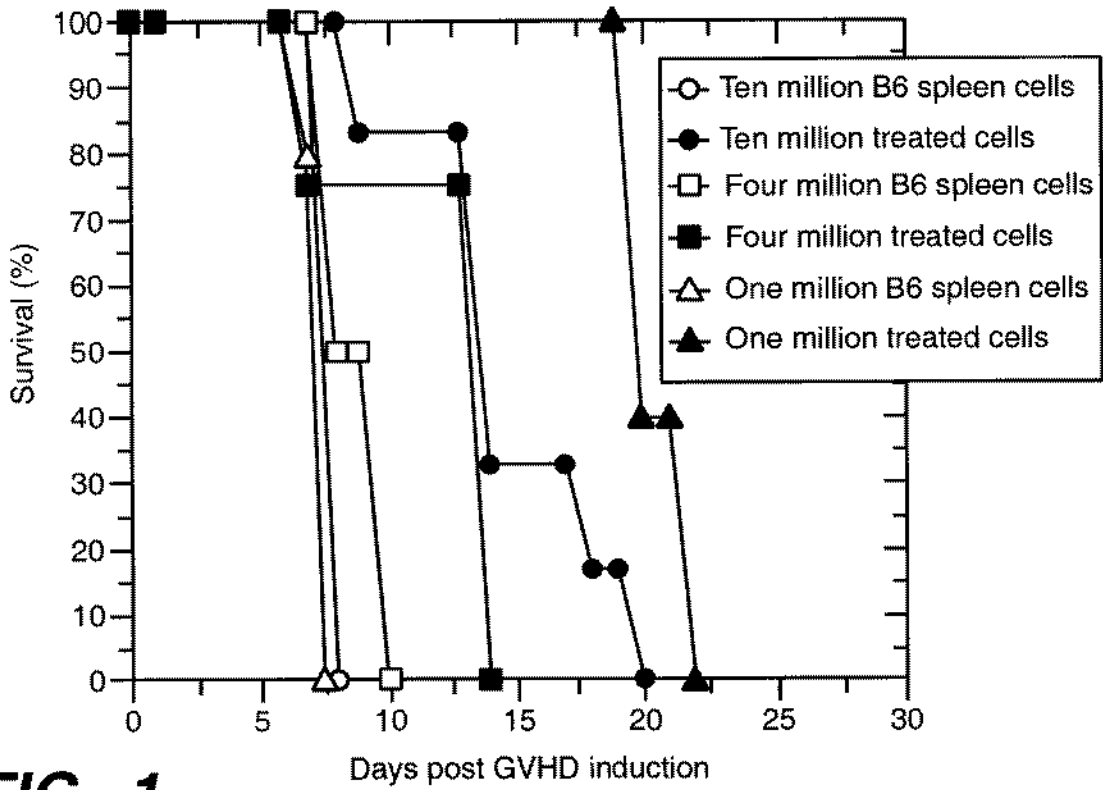


FIG. 1

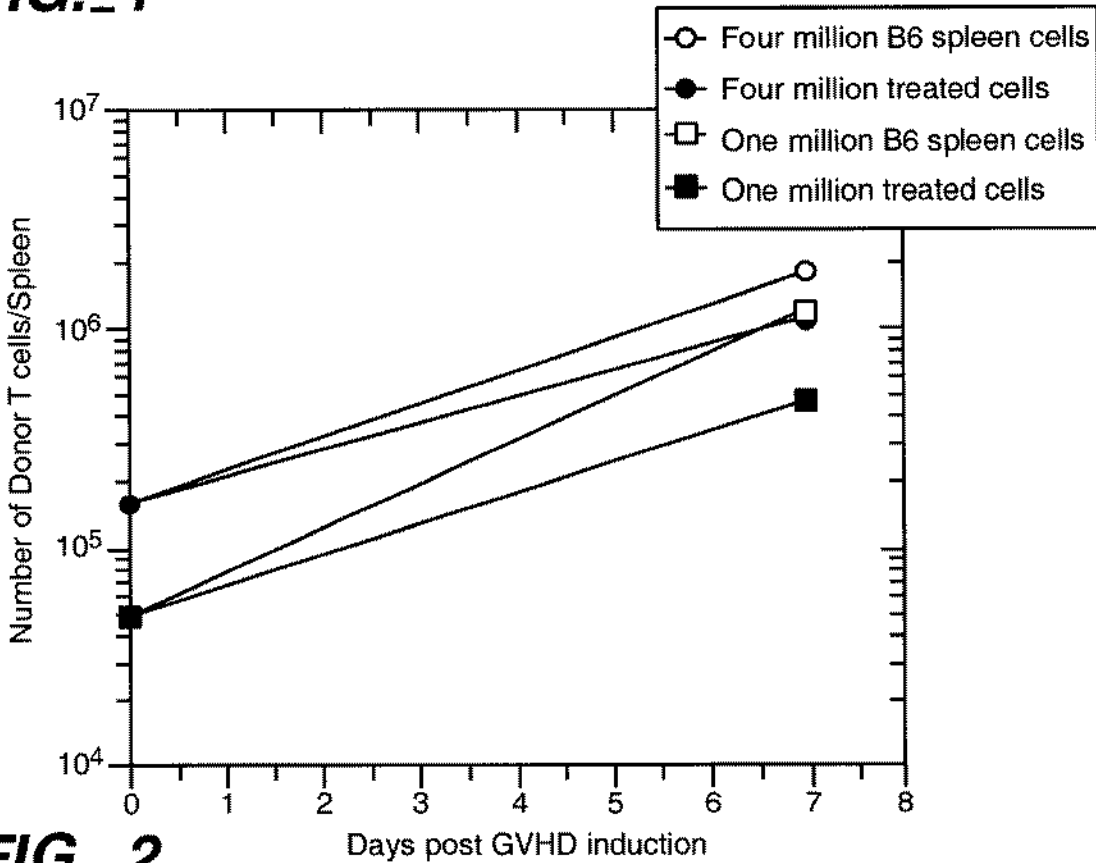


FIG. 2

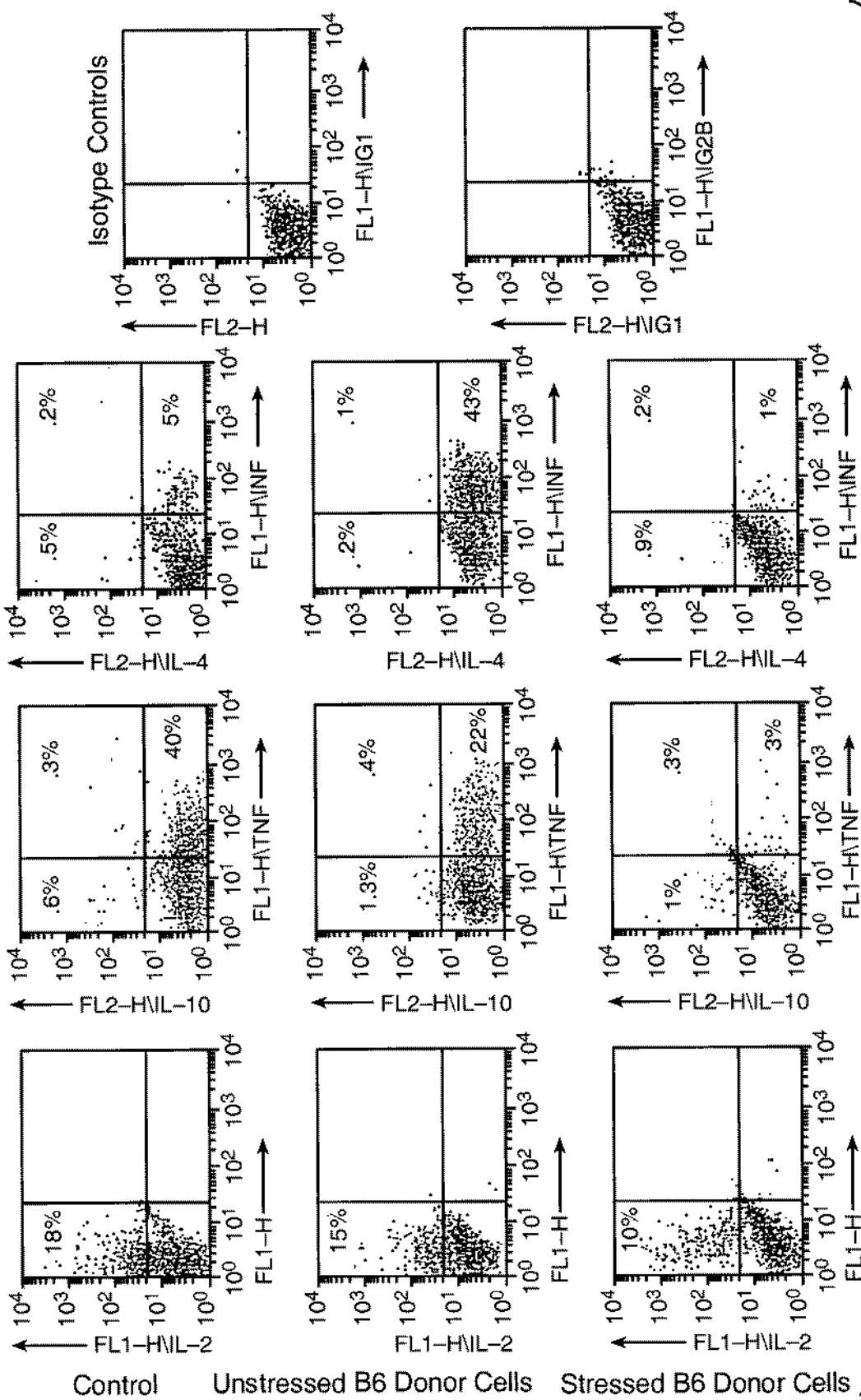


FIG. 3

1

## INHIBITION OF GRAFT VERSUS HOST DISEASE

### FIELD OF THE INVENTION

This invention relates to cellular compositions useful in medical treatments, processes for their preparation and their uses in medical treatments. More specifically, it relates to cellular compositions useful in alleviation of complications following allogeneic bone marrow transplantation, namely graft versus host disease in mammalian patients, especially in human patients, and to processes for preparation of such compositions of matter.

### BACKGROUND OF THE INVENTION

Bone marrow transplantation, BMT, is indicated following a process which destroys bone marrow. For example, following intensive systemic radiation or chemotherapy, bone marrow is the first target to fail. Metastatic cancers are commonly treated with very intensive chemotherapy, which is intended to destroy the cancer, but also effectively destroys the bone marrow. This induces a need for BMT. Leukemia is a bone marrow malignancy, which is often treated with BMT after chemotherapy and/or radiation has been utilized to eradicate malignant cells. BMT is currently used for treatment of leukemias which are life-threatening. Some autoimmune diseases may be severe enough to require obliteration of their native immune systems which includes concomitant bone marrow obliteration and requires subsequent bone marrow transplantation. Alleviation of any but the most acute life-threatening conditions involving bone marrow disorders with BMT is, however, generally regarded as too risky, because of the likelihood of the onset of graft versus host disease.

Graft-versus-host disease, GVHD, is an immunological disorder that is the major factor that limits the success and availability of allogeneic bone marrow or stem cell transplantation (collective referred to herein as allo-BMT) for treating some forms of otherwise incurable hematological malignancies, such as leukemia. GVHD is a systemic inflammatory reaction which causes chronic illness and may lead to death of the host mammal. At present, allogeneic transplants invariably run a severe risk of associated GVHD, even where the donor has a high degree of histocompatibility with the host.

GVHD is caused by donor T-cells reacting against systemically distributed incompatible host antigens, causing powerful inflammation. In GVHD, mature donor T-cells that recognize differences between donor and host become systemically activated. Current methods to prevent and treat GVHD involve administration of drugs such as cyclosporin-A and corticosteroids. These have serious side effects, must be given for prolonged periods of time, and are expensive to administer and to monitor. Attempts have also been made to use T-cell depletion to prevent GVHD, but this requires sophisticated and expensive facilities and expertise. Too great a degree of T-cell depletion leads to serious problems of failure of engraftment of bone marrow stem cells, failure of hematopoietic reconstitution, infections, or relapse. More limited T-cell depletion leaves behind cells that are still competent to initiate GVHD. As a result, current methods of treating GVHD are only successful in limited donor and host combinations, so that many patients cannot be offered potentially life-saving treatment.

### BRIEF REFERENCE TO THE PRIOR ART

International Patent Application No. PCT/CA97/00564 Bolton describes an autovaccine for alleviating the symp-

2

toms of an autoimmune disease in a mammalian patient, comprising an aliquot of modified blood obtained from the same patient and treated extracorporeally with ultraviolet radiation and an oxygen/ozone gas mixture bubbled therethrough, at an elevated temperature (42.5° C.), the autovaccine being re-administered to the same patient after having been so treated.

It is an object of the present invention to provide a process of alleviating the development of GVHD complications in a mammalian patient undergoing allo-BMT procedures.

### SUMMARY OF THE INVENTION

According to the present invention, a patient being treated by allo-BMT is administered a composition containing T-cells obtained from an allogeneic donor, said T-cells having been subjected in vitro to oxidative stress to induce therein decreased inflammatory cytokine production coupled with reduced proliferative response. It appears that such oxidatively stressed allogeneic T-cells when injected into a mammalian patient, have a down-regulated immune response and a down-regulated destructive allogeneic response against the recipient, so that engraftment of the hematopoietic stem cells, administered along with or separately from the stressed T-cells, can take effect with significantly reduced risk of development of GVHD. The population of stressed T-cells nevertheless appears to be able to exert a sufficient protective effect on the mammalian system to guard against failure of engraftment and against infection, whilst the hematopoietic system is undergoing reconstitution, at least in part, by proliferation and differentiation of the allogeneic stem cells.

One aspect of the present invention provides, accordingly, a process of treating a mammalian patient for alleviation of a bone marrow mediated disease, with alleviation of consequently developed graft versus host disease (GVHD), which comprises administering to the patient allogeneic hematopoietic stem cells and allogeneic T-cells, at least a portion of said T-cells having been subjected to oxidative stress in vitro, prior to administration to the patient, so as to induce an altered cytokine production profile and a reduced proliferative response therein.

Another aspect of the present invention provides a population of mammalian T-cells, essentially free of stem cells, said T-cells having been subjected in vitro to oxidative stress so as to induce in said cells an altered cytokine production profile and a reduced proliferative response.

A further aspect of the present invention provides a process for preparing an allogeneic cell population for administration to a human patient suffering from a bone marrow mediated disease, which comprises subjecting, in vitro, a population of donor cells enriched in T-cells to oxidative stress to induce in said T-cells an altered cytokine production profile and a reduced proliferative response.

### BRIEF REFERENCE TO THE DRAWINGS

FIGS. 1 and 2 of the accompanying drawings are graphical presentations of results obtained according to Example 3 below.

FIG. 3 is a depiction of the results obtained from Example 4 below.

### DESCRIPTION OF THE PREFERRED EMBODIMENTS

The process of the present invention involves an initial collection of hematopoietic stem cells and T-cells from a

donor. The preferred source of such cells is mobilized stem cells and T-cells from the peripheral blood of the donor. Stem cells are present in very small quantities in peripheral blood, and one preferred way of operating in accordance with the invention is to enrich the stem cell population of the donor's peripheral blood, and then to extract the donor's peripheral blood for use as a source of stem cells and T-cells for treatment as described and subsequent injection into the patient. Enrichment may be achieved by giving the donor a course of injections of appropriate growth factors, over several days e.g. five days prior to extracting peripheral blood from the donor. Appropriate cell fractions can be collected from the blood by leukopheresis, a known procedure, as it is extracted, with the plasma and red cells being returned to the donor, in a closed flow system. The white cell collection, which contains the stem cells (about 3%) and T-cells (about 40%) along with B-cells, neutrophils and other white cells, may be treated to alter their cytokine production profiles and to reduce the proliferative response of the T-cells therein, and then administered to the host patient, in accordance with the invention, as a whole collection of cells (peripheral blood mononuclear cells). Preferably, however, the donor T-cells are separated from the other cells, so that only the T-cells are subjected to oxidative stress and then administered to the patient, with the stem cells for engraftment being administered to the patient separately from the treated T-cells. For practical purposes, however, subsection of the collection of peripheral blood mononuclear cells to the stressors is satisfactory, without further fractionation to isolate the T-cells, which is a difficult and expensive procedure. Separate administration of stem cells is strongly preferred.

If for some reason it is desired to subject the entire white cell collection to oxidative stress to induce the aforementioned changes in the T-cell portion thereof, and then administer the entire collection to the patient, it is preferred to protect the stem cells from any damaging effects of the oxidative stress in a manner described below.

In an alternative, but less preferred, procedure, whole bone marrow of the donor can be used as the source of T-cells and stem cells for the process of the invention. Whole bone marrow has in the past been the usual source of cells for allogeneic cell transplantation procedures, and can indeed be used in the present process. It is however an inconvenient and uncomfortable procedure for the donor, requiring anaesthetic and lengthy extraction procedures. Any source of T-cells and stem cells from the donor can be used in principle, but peripheral blood enriched in stem cells and T-cells is the most clinically convenient.

The alteration in cytokine production profile induced in the T-cells in the process of the invention is preferably a reduction in production of inflammatory cytokines, such as interferon- $\gamma$  and tissue necrosis factor- $\alpha$ .

The oxidative stress may be applied to the T-cells by subjecting them to an oxidative environment such as the addition of a gaseous, liquid or solid chemical oxidizing agent (ozone, molecular oxygen, ozone/oxygen gas mixtures, permanganates, periodates, peroxides, drugs acting on biological systems through an oxidative mechanism such as adriamycin, and the like). In one preferred method according to the invention, the T-cells are subjected, in suspension, to a gaseous oxidizing agent, such as an ozone/oxygen gas mixture bubbled through the suspension of cells, optionally in combination with the simultaneous subsection of the cells to ultraviolet radiation, in appropriate doses.

One method according to the present invention subjects the allogeneic white cells from the donor, including both the

stem cells and the T-cells, to oxidative stress. This eliminates the need to include a complicated and costly step of separating the T-cells from the other cellular components of the white cells composition. In such case, however, it is strongly preferred to protect the stem cells in the composition from deleterious effects of the stress. This can be accomplished by including one or more stem cell growth factors in the cell composition at the time of subjecting it to the stress. Protection of the stem cells from the deleterious effects of the oxidative stress is achieved by the presence of growth factors, and so, prior to subjecting the stem cell-T-cell composition to oxidative stress, one or more stem cell growth factors are added to the composition. Stem cell growth factors useful in the process are cytokines which promote survival of stem cells (but not T-cells) during this stressing. They are cytokines which interact with growth receptors on stem cells. They are believed to activate the MAP-kinase pathway of the cell, resulting in the activation of erk. Examples of suitable such growth factors, include stem cell specific growth factors, kit-ligand, IL-3, GM-CSF and FLT 3 ligand, all of which are known. It is preferred to add precise amounts of extracted, purified growth factors or, especially, recombinant growth factors available on the market, or combinations thereof, suitably dissolved or suspended in appropriate, biologically acceptable fluids.

One preferred method of subjecting the allogeneic T-cells to oxidative stress according to the invention involves exposing a suspension of the cells to a mixture of medical grade oxygen and ozone gas, for example by bubbling through the suspension a stream of medical grade oxygen gas having ozone as a minor component therein. The suspending medium may be any of the commonly used biologically acceptable media which maintains cells in viable condition. The ozone gas may be provided by any conventional source known in the art. Suitably the gas stream has an ozone content of from about 1.0–100  $\mu\text{g}/\text{ml}$ , preferably 3–70  $\mu\text{g}/\text{ml}$  and most preferably from about 5–50  $\mu\text{g}/\text{ml}$ . The gas stream is supplied to the aliquot at a rate of from about 0.01–2 liters per minute, preferably 0.05–1.0 liters per minute, and most preferably at about 0.06–0.30 liters per minute (STP).

Another method of subjecting the T-cells to oxidative stress to render them suitable for use in the present invention is to add to a suspension of the cells a chemical oxidant of appropriate biological acceptability, and in biologically acceptable amounts. Permanganates, periodates and peroxides are suitable, when used in appropriate quantities. Hydrogen peroxide is useful in demonstrating the effectiveness of the process of the invention and in giving guidance on the appropriate quantity of oxidizing agent to be used, although it is not an agent of first choice for the present invention, for practical reasons. Thus, a suitable amount of oxidizing agent is hydrogen peroxide in a concentration of from 1 micromolar–2 millimolar, contacting a 10 ml suspension containing from  $10^{-6}$  to  $10^{-8}$  cells per ml, for 20 minutes, or equivalent oxidative stress derived from a different oxidizing agent. Optimum is about 1 millimolar hydrogen peroxide in such a suspension for about 20 minutes, or the equivalent of another oxidizing agent calculated to give a corresponding degree of oxidative stress to the cells.

The size of the cell suspension to be subjected to oxidative stress is generally from about 0.1 ml to about 1000 ml, preferably from about 1–500, and containing appropriate numbers of T-cells for subsequent administration to a patient undergoing allo-BMT. These numbers generally correspond to those used in prior methods of allogeneic T-cell admin-

istration in connection with allo-BMT, and are familiar to those skilled in the art.

One specific process according to the invention is to subject the cell suspension simultaneously to oxygen/ozone bubbled through the suspension and ultraviolet radiation. This also effects the appropriate changes in the nature of the T-cells. Care must be taken not to utilize an excessive dosage of oxygen/ozone or UV, to the extent that the cell membranes are caused to be disrupted, or other irreversible damage is caused to an excessive number of the cells.

The temperature at which the T-cell suspension is subjected to the oxidative stress does not appear to be critical, provided that it keeps the suspension in the liquid phase and is not so high that it causes cell membrane disruption. The temperature should not be higher than about 45° C.

When ultraviolet radiation is used in conjunction with the oxygen/ozone oxidative stressor, it is suitably applied by irradiating the suspension under treatment from an appropriate source of UV radiation, while the aliquot is maintained at the aforementioned temperature and while the oxygen/ozone gaseous mixture is being bubbled through the aliquot. The ultraviolet radiation may be provided by any conventional source known in the art, for example by a plurality of low-pressure ultraviolet lamps. There is preferably used a standard UV-C source of ultraviolet radiation, namely UV lamps emitting primarily in the C-band wavelengths, i.e. at wavelengths shorter than about 280 nm. Ultraviolet radiation corresponding to standard UV-A and UV-B sources can also be used. Preferably employed are low-pressure ultraviolet lamps that generate a line spectrum wherein at least 90% of the radiation has a wavelength of about 254 nm. An appropriate dosage of such UV radiation, applied simultaneously with the aforementioned temperature and oxidative environment stressors, is obtained from lamps with a power output of from about 5 to about 25 watts, preferably about 5 to about 10 watts, at the chosen UV wavelength, arranged to surround the sample container holding the aliquot. Each such lamp provides an intensity, at a distance of 1 meter, of from about 40–80 micro watts per square centimeter. Several such samples surrounding the sample container, with a combined output at about 254 nm of 15–40 watts, preferably 20–40 watts, operated at maximum intensity may advantageously be used. At the incident surface of the aliquot, the UV energy supplied may be from about 0.25–4.5 j/cm<sup>2</sup> during a 3-minute exposure, preferably 0.9–1.8 j/cm<sup>2</sup>. Such a treatment provides a suspension aliquot which is appropriately modified according to the invention ready for injection into the patient.

The time for which the aliquot is subjected to the stressors can be from a few seconds to about 60 minutes. It is normally within the time range of from about 0.5–60 minutes. This depends to some extent upon the chosen intensity of the UV irradiation, the temperature and the concentration of and rate at which the oxidizing agent is supplied to the aliquot. Some experimentation to establish optimum times and dosages may be necessary on the part of the operator, once the other stressor levels have been set. Under most stressor conditions, preferred times will be in the approximate range of about 0.5–10 minutes, most preferably 2–5 minutes, and normally around 3 minutes.

In the practice of one preferred process of the present invention, the suspension of cells may be treated with oxygen/ozone gas mixture and optionally also with UV radiation using an apparatus of the type described in U.S. Pat. No. 4,968,483 Mueller. The suspension is placed in a suitable, sterile, UV-radiation-transmissive container, which is then fitted into the machine. The temperature of the aliquot is adjusted to the predetermined value, e.g. 42.5±1° C., by the use of a suitable heat source such as an IR lamp, and the UV lamps are switched on for a fixed period before the gas

flow is applied to the aliquot providing the oxidative stress, to allow the output of the UV lamps to stabilize. The oxygen/ozone gas mixture, of known composition and control flow rate, is applied to the aliquot, for the predetermined duration of 0.5–60 minutes, preferably 1–5 minutes and most preferably about 3 minutes as discussed above. In this way, the suspension is appropriately modified according to the present invention sufficient to achieve the desired effects of alleviation or prevention of GVHD.

From another aspect, the preferred embodiment of the present invention may be viewed as a process of treating allogeneic T-cells prior to their introduction into a patient, by extracorporeally stressing the T-cells, which comprises subjecting the T-cells to oxidative stress such as exposure to ozone or ozone/oxygen. The treated allogeneic T-cells from the process of the invention have a direct effect on the development and progression of GVHD. The donor T-cells pretreated according to the process of the invention prior to introduction into the host patient, have been modified, so that they no longer mount a deleterious response. Their ability to mount an inflammatory cytokine response has been decreased. For example their ability to secrete IFN $\gamma$ , TNF $\alpha$  and IL-2, and their proliferative response to standard mitogens has been reduced. Accordingly they no longer react against incompatible systemically distributed host histocompatibility antigens to cause inflammation to any great extent. The allogeneic stem cells administered to the patient can proceed with engraftment with improved chance of success. After a period of time, the treated T-cells largely recover their proliferative ability and immune response functions, but remain relatively unresponsive (tolerant) to differing host histocompatibility antigens.

The invention is further described, for illustrative purposes, in the following specific examples.

#### SPECIFIC DESCRIPTION OF THE MOST PREFERRED EMBODIMENTS

The spleen of a mammal offers a convenient, accessible source of cells, especially T-cells but also including small quantities of stem cells and is particularly useful in connection with animal models for experimental purposes.

Experimental testing to obtain indication of the utility of the process of the present invention was conducted using a model of acute GVHD in SCID mice. T-cells from C57B1/6J (B6) mice were intravenously injected into sub-lethally irradiated CB-17 SCID mice. The latter are congenitally lymphopenic and provide a strong stimulus for donor cells due to their complete disparity at the major histocompatibility locus (MHC). The mean survival time of host mice in this model is 14 days. GVHD is characterized by suppression of host hematopoietic recovery from irradiation; expansion of T-cells that use V $\beta$ 3 chain to form their T-cell receptor complexes (TCR's); spontaneous secretion of interferon- $\gamma$  and TNF- $\alpha$ , by donor T-cells, and aberrant localization of donor T-cells to the red pulp areas of the spleen. If donor marrow is co-injected with T-cells, a chronic form of GVHD results.

#### EXAMPLE 1

Mouse spleen cells from C57B1/6J (B6) mice were suspended to a density of 10<sup>7</sup>/ml in  $\alpha$ -MEM, 2ME and 10% fetal calf serum (FCS). The FCS contains cytokines and growth factors. The cell suspension was subjected simultaneously to ultraviolet radiation from UV-C lamps, wavelength 253.7 nm, whilst bubbling through the suspension a gas mixture of 14–15 mcg/ml ozone/medical grade oxygen, at 42.5° C. The treatment took place for 3 minutes.

Immediately after the treatment, the cells had a viability of only about 10%.



EXAMPLE 2

The experiment of Example 1 was essentially repeated except that the cells were suspended in 100% FCS. The immediate survival of the cells in this case was 50-60%, indicating that factors present in the FCS have exerted a protective effect on at least some of the cells.

EXAMPLE 3

Murine B6 spleen cells suspended in 100% FCS were subjected to UV-oxidation-heat treatment. The cell suspension was subjected simultaneously to ultraviolet radiation from UV-C lamps, wavelength 253.7 nm, whilst bubbling through the suspension a gas mixture of 14-15 mcg/ml ozone/medical grade oxygen, at 42.5° C. The treatment took place for 3 minutes. Varying numbers were injected into sub-lethally irradiated CB-17 SCID mice. Their subsequent behaviour was compared with similar numbers of B6 spleen cells, not subjected to the treatment.

FIG. 1 is a graphical presentation of the results of these experiments, where the % survival of the animals in each group is plotted as ordinate against days following injection of the treated or untreated cells. At all dosage levels, there is a marked improvement of survival when the treated cells are used as opposed to the untreated cells, demonstrating potential for the process of the invention in alleviating GVHD.

FIG. 2 of the accompanying drawings is a plot of the number of donor T-cells per spleen against days after GVHD induction, in these same experiments. This shows that the treated donor T-cells survive and expand in number in the host mice, although to a more limited degree than control, untreated B6 T-cells.

EXAMPLE 4

Six days after initiation of GVHD in the mice by injection of the donor cells (treated and untreated), donor T-cells were separated from SCID spleen cells by density gradient centrifugation. Intracellular cytokine staining was performed according to the method of Ferrick, D. A. et. al., NATURE 373 225, 257, 1995. The staining was performed on spleen cell suspensions on day 8 after injection of B6 spleen cells. Cytokine production was determined 4 hours after stimulation in vitro with PHA and ionomycin in the presence of brefeldin-A and after gating on CD4<sup>+</sup> and CD8<sup>+</sup>. The results were assessed by intracellular flow cytometry, and the results thereof are depicted in FIG. 3 of the accompanying drawings. The percentage of each cells in each quadrant is recorded. The drawing shows significantly reduced levels of the inflammatory cytokines interferon-γ (INF) and tissue necrosis factor-α (TNF), lower right quadrants, from the T-cells which had been stressed as described in Example 1, as compared with untreated cells and controls.

EXAMPLE 5

Inversion of the normal ratio of CD4+ to CD8+ T-cells (usually approximately 2:1) is known to accompany GVHD. By intracellular cytokine staining techniques following the method of Ferrick et.al., Nature 373: 255-257, 1995 and using anti-CD4 and CD8-tricolor antibodies, CD4/CD8 ratios were determined. In the untreated donor spleen cells after injection into sub-lethally irradiated mice, the inversion of the normal ratio was confirmed. The initial CD4/CD8 ratios of 1.3±0.2 and 2.2±0.3 decreased to 0.33±0.05 and 0.9±0.1 by day 13 for unstressed B6 and C3H donor T cells, respectively, at a time when many animals were succumbing to GVHD. In contrast, the ratios remained greater than 1 at all times and correlated with the lack of clinical evidence of

GVHD when donor cells had been pretreated with the stressors as described in Example 1.

EXAMPLE 6

This example demonstrates the principle of the invention, using oxidative stress alone, provided by hydrogen peroxide, an effective chemical oxidizing agent and representative of many other, perhaps more biologically suitable, chemical oxidizing agents.

Peripheral human blood mononuclear cells PBMCs, which is a collection of white blood cells comprising about 40% T-cells, were stressed by contact with aqueous solutions of hydrogen peroxide, of various concentrations, for 20 minutes. Their immediate survival was measured, along with their immediate phytohaemagglutinin (PHA) response. Then their survival after 24 hours was measured, followed by their PHA response (tritiated thymidine uptake following mitogenic stimulation with PHA) and cytokine profile after 7 days. The results are given in the following table.

TABLE

Conc. H <sub>2</sub> O <sub>2</sub>	Immediate survival %	24 hr survival %	Immediate PHA response	PHA response 7-day	Cytokine Profile
100 μmole/L	80-90	100	2000	+	IFN↓
300 μmole/L	80-90	50	2000	+	IFN↓
1 mmole/L	80-90	40	400	+	IFN↓
3 mmole/L	80-90	40	400	+	IFN↓
Control	95	95	8575	+	IFN↑

These results indicate that T-cells subjected to oxidative stress alone achieve a decreased proliferative response and decreased inflammatory cytokine production, suitable for use in the present invention.

I claim:

1. A process of alleviating the development of graft versus host disease complications in a mammalian patient undergoing or about to undergo a bone marrow transplant, which comprises extracting from an allogeneic human donor an aliquot of whole blood; separating from said aliquot a cellular fraction enriched in T-cells; subjecting said fraction to oxidative stress in vitro so as to induce decreased inflammatory cytokine production and a reduced proliferative response therein; and administering the oxidatively stressed fraction to the patient.

2. The process of claim 1, wherein the oxidatively stressed fraction of T-cells is administered to the patient separately from administration of stem cells from the allogeneic donor to the patient.

3. The process of claim 2, wherein the oxidatively stressed T-cell fraction consists essentially of peripheral blood mononuclear cells obtained from peripheral human blood.

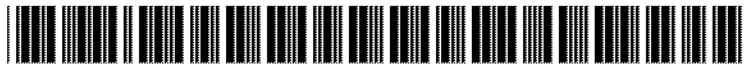
4. The process of claim 2, wherein the oxidatively stressed T-cell fraction has been subjected to oxidative stress by application thereto of a gaseous oxygen/ozone mixture.

5. The process of claim 2, wherein the oxidatively stressed T-cell fraction has been subjected to oxidative stress by application thereto of a chemical oxidizing agent.

6. The process of claim 4, wherein the oxidatively stressed T-cell fraction has been additionally subjected to UV radiation, simultaneously with the subjecting to oxidative stress.

7. The process of claim 5 wherein the oxidatively stressed T-cell fraction has been additionally subjected to UV radiation, simultaneously with the subjecting to oxidative stress.

\* \* \* \* \*



US 20020090360A1

(19) **United States**

(12) **Patent Application Publication**

**Bolton et al.**

(10) **Pub. No.: US 2002/0090360 A1**

(43) **Pub. Date: Jul. 11, 2002**

(54) **INFLAMMATORY CYTOKINE SECRETION INHIBITION**

(76) Inventors: **Anthony E. Bolton**, Derbyshire (GB);  
**Arkady Mandel**, North York (CA);  
**Daniel Nathan Sauder**, Baltimore, MD (US)

Correspondence Address:

**Gerald F. Swiss**  
**BURNS, DOANE, SWECKER & MATHIS, LLP.**  
**P.O. Box 1404**  
**Alexandria, VA 22313-1404 (US)**

(21) Appl. No.: **10/002,634**

(22) Filed: **Dec. 5, 2001**

(30) **Foreign Application Priority Data**

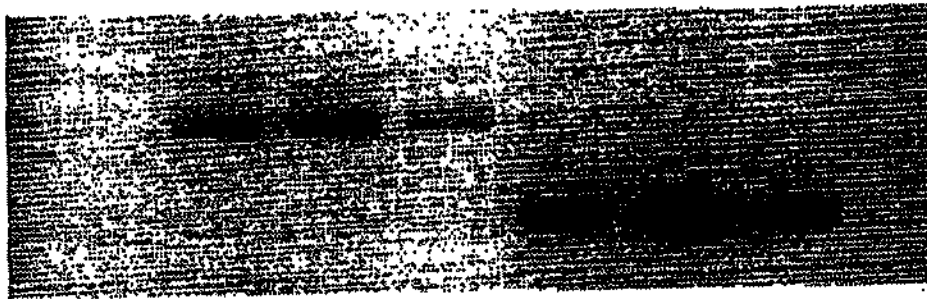
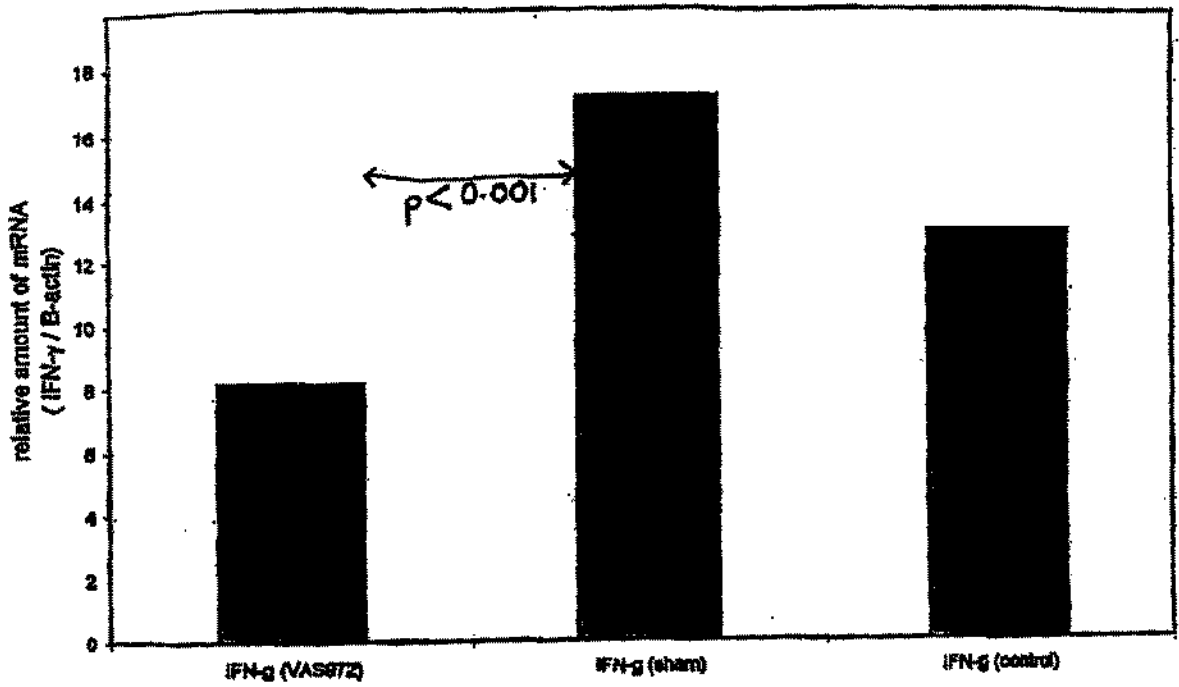
Dec. 5, 2000 (CA) ..... 2,327,631  
Dec. 5, 2000 (CA) ..... 2,327,628

**Publication Classification**

(51) **Int. Cl.<sup>7</sup>** ..... **A61K 45/00; C12N 5/08**  
(52) **U.S. Cl.** ..... **424/93.7; 435/372**

(57) **ABSTRACT**

The present invention relates to a process of decreasing the expression of one or more of the inflammatory cytokines IFN- $\gamma$  and IL-6 by cells in a mammalian patient, which comprises administering to the patient an effective amount of stressed mammalian blood cells, said stressed cells having been extracorporeally subjected to at least one stressor selected from oxidative stress and ultraviolet radiation. The process of the present invention can be used for alleviating chronic fatigue syndrome in a mammalian patient.



1 - B-actin (VAS972)  
2 - B-actin (sham)  
3 - B-actin (control)

4 - IFN- $\gamma$  (VAS972)  
5 - IFN- $\gamma$  (sham)  
6 - IFN- $\gamma$  (control)

FIG. 1

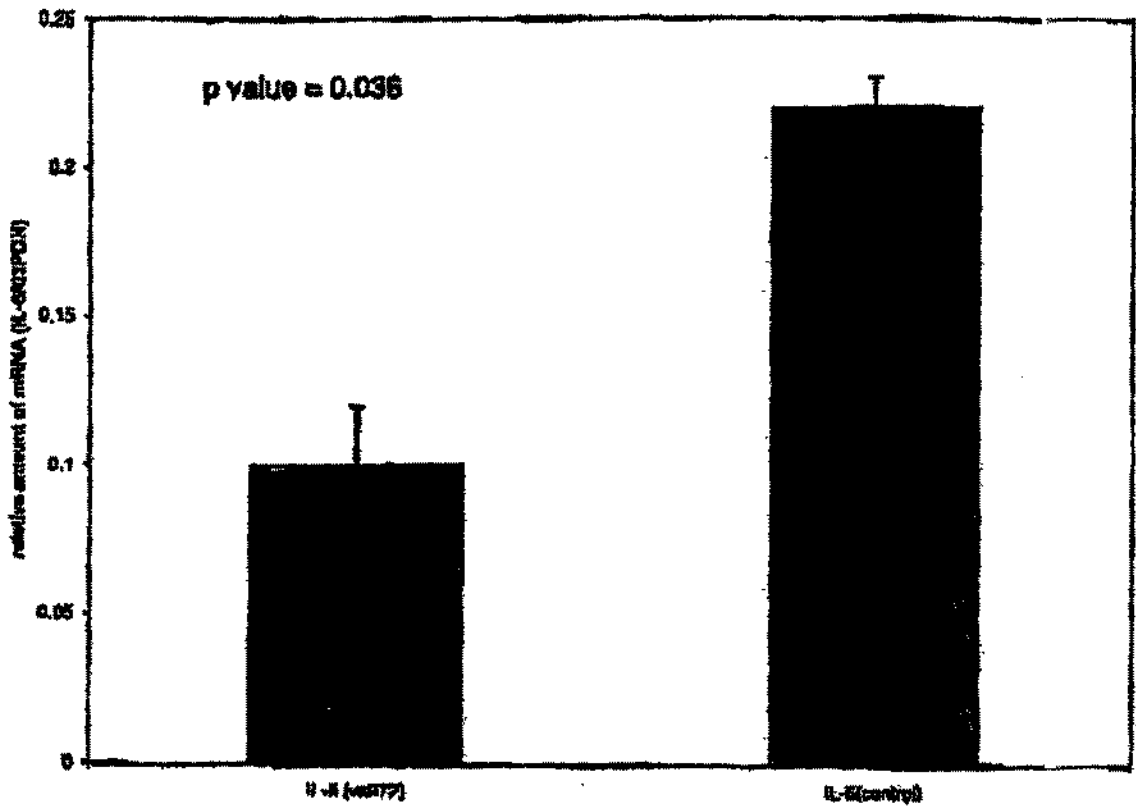


FIG. 2

## INFLAMMATORY CYTOKINE SECRETION INHIBITION

### CROSS-REFERENCE TO RELATED APPLICATIONS

[0001] This application claims convention priority from Canadian patent application serial number 2,327,631, filed Dec. 5, 2000, and from Canadian patent application serial number 2,327,628, filed Dec. 5, 2000, the disclosures of which are incorporated herein by reference in their entirety.

### FIELD OF THE INVENTION

[0002] This invention relates to treatment of biological cells and immune system modulation. More specifically, it relates to treatment of cells of the mammalian immune system to alter the cytokine profiles of certain types of constituent cells, and therapeutic applications of such treatments.

### BACKGROUND OF THE INVENTION

[0003] The mammalian immune system comprises lymphocytes (one type of white blood cell), the major components of which are B cells, which mature within the bone marrow, and T cells which migrate from the bone marrow to mature in the thymus gland. B cells react to antigens to proliferate and differentiate into memory B cells and effector B cells to generate and express antibodies specific to the antigen, thereby removing the antigen from the host. T cells have T cell receptors which recognize antigen associated with MHC molecules on a cell, and as a result of this recognition differentiate into memory T cells and various types of effector T cells. The T cell population is made up of T-helper ( $T_H$ ) cells and T-cytotoxic ( $T_C$ ) cells, distinguished from one another by the presence of the surface membrane glycoprotein CD4 on  $T_H$  cells and the surface membrane glycoprotein CD8 on  $T_C$  cells. Activation of a  $T_H$  cell can cause it to secrete various growth factors (cytokines). Different types of  $T_H$  cells secrete different cytokines. These cytokines play key roles in the immune response, including autoimmune responses.

[0004] One type of  $T_H$  cell, known as  $T_H1$ , expresses cytokines which, in excessive amounts, can cause inflammation in the mammalian body. Examples of such inflammatory cytokines include interferon- $\gamma$  (IFN- $\gamma$ ), interleukin-6 (IL-6) and interleukin-12 (IL-12). When the body produces inappropriately large amounts of inflammatory cytokines, significantly more than endogenous levels found in the corresponding non-diseased tissue of healthy individuals, either through over-activation of  $T_H1$  cells, activation of excessive numbers of  $T_H1$  cells, or a switch of other types of T cells to the  $T_H1$  type to create excessive numbers of cytokines expressing  $T_H1$  cells, an inflammatory disorder can manifest itself in a patient.

### SUMMARY OF THE INVENTION

[0005] The present invention provides a process whereby expression of inflammatory cytokines including IFN- $\gamma$  and IL-6, either individually or in combination, is reduced in a mammalian patient body. This process involves introducing blood cells into the patient which cells have been extracorporeally stressed by subjection to an oxidative stress and/or ultraviolet radiation. On introduction of these stressed blood

cells, there is a reduction in the expression of one or more of these inflammatory cytokines, either by down regulating  $T_H1$  cells, or perhaps by decreasing the population of  $T_H1$  cells, e.g. by causing a switch of T cells from  $T_H1$  to  $T_H2$ . Whatever the precise mechanism of action, the result is a significant and measurable decrease in these inflammatory cytokines in the patient's system. Accordingly, the process of the invention is useful in the medical treatment of patients suffering from, prone to, or at risk of contracting a disorder associated with excessive amounts of one or more of the inflammatory cytokines IFN- $\gamma$  and IL-6 (e.g., chronic fatigue syndrome—see Cannon et.al., *J. Clin. Immunol.* 19(6): 414-21, 1999; and Gupta, S. et.al., *Int. J. Mol.Med.* 3(2): 209-13, 1999).

[0006] Thus according to the present invention, there is provided a process of decreasing the expression of one or more of the inflammatory cytokines IFN- $\gamma$  and IL-6 by cells in a mammalian patient, which comprises administering to the patient an effective amount of stressed mammalian blood cells, said stressed cells having been extracorporeally subjected to at least one stressor selected from oxidative stress and ultraviolet radiation.

[0007] There is further provided a method for treating an inflammatory disease condition in a patient mediated by inflammatory cytokine production, which method comprises administering to the patient an effective amount of stressed mammalian blood cells wherein said stressed mammalian blood cells have been extracorporeally subjected to at least one stressor selected from oxidative conditions and ultraviolet radiation.

### BRIEF REFERENCE TO THE DRAWING

[0008] The accompanying FIGS. 1 and 2 are graphical presentations of the results of the experiments reported below in the Examples.

### DESCRIPTION OF THE PREFERRED EMBODIMENTS

[0009] A preferred embodiment of the invention is a process of decreasing the expression of IL-6 from cells in a mammalian patient, which comprises administering to the patient an effective amount of stressed mammalian blood cells, said stressed cells having been extracorporeally subjected to at least one stressor selected from oxidative stress and ultraviolet radiation. Such a process is useful in treating medical disorders associated with excess expression or excess presence of IL-6. A preferred application of the process of the present invention is in the treatment of disorders mediated by excess expression or excess presence of IL-6 other than graft versus host disease (GVHD); autoimmune diseases, such as rheumatoid arthritis, psoriasis, scleroderma, lupus, diabetes mellitus, organ rejection, miscarriage, multiple sclerosis, inflammatory bowel disease and atherosclerosis; and contact hypersensitivity disorders.

[0010] A particularly preferred embodiment is a process of decreasing IL-6 expression by cells in a mammalian patient which comprises administering to the patient an effective amount of stressed mammalian blood cells, said stressed cells having been extracorporeally subjected to at least one stressor selected from oxidative stress and ultraviolet radiation. This process is particularly useful for alleviating disorders such as chronic fatigue syndrome.

[0011] The source of the stressed blood cells for use in the present invention is preferably the patient's own blood, i.e. an aliquot of autologous blood.

[0012] The terms "aliquot", "aliquot of blood" or similar terms used herein include whole blood; separated cellular fractions of the blood, including platelets; separated non-cellular fractions of the blood, including plasma; plasma components; and combinations thereof. Preferably, in human patients, the volume of the aliquot is up to about 400 ml, preferably from about 0.1 to about 100 ml, more preferably from about 1 to about 15 ml, even more preferably from about 8 to about 12 ml, and most preferably about 10 ml. The effect of the stressor or the combination of stressors is to modify the blood, and/or the cellular or non-cellular fractions thereof, contained in the aliquot. The modified aliquot is then re-introduced into the subject's body by any suitable method, most preferably intramuscular injection, but also including subcutaneous injection, intraperitoneal injection, intra-arterial injection, intravenous injection and oral administration, following which it causes decrease in the expression of one or more of the inflammatory cytokines  $\text{INF-}\gamma$  and IL-6.

[0013] According to a preferred process of the present invention, an aliquot of blood is extracted from a mammalian subject, preferably a human, and the aliquot of blood is treated ex vivo, simultaneously or sequentially, with the aforementioned stressors. Then it is injected back into the same subject. Preferably a combination of both of the aforementioned stressors is used.

[0014] Preferably, the aliquot of blood is in addition subjected to mechanical stress. Such mechanical stress includes stress that is that applied to the aliquot of blood by extraction of the blood aliquot through a conventional blood extraction needle, or a substantially equivalent mechanical stress, shortly before the other chosen stressors are applied to the blood aliquot. This mechanical stress may be supplemented by a mechanical stress exerted on the blood aliquot by bubbling gases through it, such as ozone/oxygen mixtures, as described below. Optionally, a temperature stressor may be applied to the blood aliquot, simultaneously or sequentially with the other stressors, i.e. a temperature at, above or below body temperature.

[0015] The optionally applied temperature stressor either warms the aliquot being treated to a temperature above normal body temperature or cools the aliquot below normal body temperature. The temperature is selected so that the temperature stressor does not cause excessive hemolysis in the blood contained in the aliquot, and so that, when the treated aliquot is injected into a subject, the desired effect will be achieved without the development of significant adverse side effects. Preferably, the temperature stressor is applied so that the temperature of all or a part of the aliquot is up to about  $55^{\circ}\text{C}$ ., and more preferably in the range of from about  $-5^{\circ}\text{C}$ . to about  $55^{\circ}\text{C}$ ., but maintaining the aliquot largely in the liquid phase.

[0016] In some preferred embodiments of the invention, the temperature of the aliquot is raised above normal body temperature, such that the mean temperature of the aliquot does not exceed a temperature of about  $55^{\circ}\text{C}$ ., more preferably from about  $40^{\circ}\text{C}$ . to about  $50^{\circ}\text{C}$ ., even more preferably from about  $40^{\circ}\text{C}$ . to about  $44^{\circ}\text{C}$ ., and most preferably about  $42.5\pm 1^{\circ}\text{C}$ .

[0017] In other preferred embodiments, the aliquot is cooled below normal body temperature such that the mean temperature of the aliquot is within the range of from about  $4^{\circ}\text{C}$ . to about  $36.5^{\circ}\text{C}$ ., more preferably from about  $10^{\circ}\text{C}$ . to about  $30^{\circ}\text{C}$ ., and even more preferably from about  $15^{\circ}\text{C}$ . to about  $25^{\circ}\text{C}$ .

[0018] The oxidative environment stressor can be the application to the aliquot of solid, liquid or gaseous oxidizing agents. Preferably, it involves exposing the aliquot to a mixture of medical grade oxygen and ozone gas, most preferably by applying to the aliquot medical grade oxygen gas having ozone as a component therein. The ozone content of the gas stream and the flow rate of the gas stream are preferably selected such that the amount of ozone introduced to the blood aliquot, either on its own or in combination with one of the other stressors, does not give rise to excessive levels of cell damage, i.e. a degree of cell damage can be tolerated as long as it is without significant adverse side effects. Suitably, the gas stream has an ozone content of up to about  $300\ \mu\text{g/ml}$ , preferably 0.1 up to about  $100\ \mu\text{g/ml}$ , more preferably up to about  $30\ \mu\text{g/ml}$ , even more preferably up to about  $20\ \mu\text{g/ml}$ , particularly preferably from about  $10\ \mu\text{g/ml}$  to about  $20\ \mu\text{g/ml}$ , and most preferably about  $14.5\pm 1.0\ \mu\text{g/ml}$ . The gas stream is suitably supplied to the aliquot at a rate of up to about 2.0 litres/min, preferably up to about 0.5 litres/min, more preferably up to about 0.4 litres/min, even more preferably up to about 0.33 litres/min, and most preferably about  $0.24\pm 0.024$  litres/min. The lower limit of the flow rate of the gas stream is preferably not lower than 0.01 litres/min, more preferably not lower than 0.1 litres/min, and even more preferably not lower than 0.2 litres/min, all rates at STP ( $0^{\circ}\text{C}$ . and 1 atmosphere pressure). In the alternative, chemical oxidants such as hydrogen peroxide, permanganates and periodates, of biologically acceptable types and in biologically acceptable concentrations, can be used in the liquid phase to provide the required oxidative environment.

[0019] The ultraviolet light stressor is suitably applied by irradiating the aliquot under treatment from a source of UV light, i.e. electromagnetic radiation of wavelength from about 180-400 nm. Preferred UV sources are UV lamps emitting UV-C band wavelengths, i.e. wavelengths shorter than about 280 nm. Ultraviolet light corresponding to standard UV-A (i.e., wavelengths from about 315 to about 400 nm) and UV-B (i.e., wavelengths from about 280 to about 315 nm) sources can also be used. The UV dose should be selected, on its own or in combination with the other chosen stressor(s), so that excessive amounts of cell damage do not occur, and so that, when the treated aliquot is injected into a subject, the desired effect will be achieved. For example, an appropriate dosage of such UV light, applied simultaneously with the aforementioned temperature and oxidative environment stressor, can be obtained from lamps with a power output of from about 10 to about 30 watts, arranged to surround the sample container holding the aliquot, each lamp providing an intensity, at a distance of 16 mm, of from about 5 to about  $20\ \text{mW/cm}^2$ . Up to eight such lamps surrounding the sample bottle, with a combined output at 253.7 nm of 10-30 watts, operated at an intensity to deliver a total UV light energy at the surface of the blood of from about 0.025 to about  $10\ \text{joules/cm}^2$ , preferably from about 0.1 to about  $3.0\ \text{joules/cm}^2$ , may advantageously be used. Such a treatment, applied in combination with the oxidative

environment stressor, provides a modified blood aliquot which is ready for injection into the subject.

**[0020]** It is preferred to subject the aliquot to the oxidative environment stressor, the UV light stressor and the temperature stressor simultaneously, following the subsection of the aliquot to the mechanical stress, e.g. by extraction of the blood from the patient. Thus, the aliquot may be maintained at a predetermined temperature above or below body temperature while the oxygen/ozone gas mixture is applied thereto and while it is irradiated with ultraviolet light.

**[0021]** The time for which the aliquot is subjected to the stressors is normally within the time range of from about 0.5 minutes up to about 60 minutes. The time depends to some extent upon the chosen combination of stressors. When UV light is used, the intensity of the UV light may affect the preferred time. The chosen temperature level may also affect the preferred time. When oxidative environment in the form of a gaseous mixture of oxygen and ozone applied to the aliquot is chosen as one of the two stressors, the concentration of the oxidizing agent and the rate at which it is supplied to the aliquot may affect the preferred temperature. Some routine experimentation to establish optimum times may be necessary on the part of the operator, once the other stressor levels have been set, such experimentation being well within the skill of the art. Under most stressor conditions, preferred times will be in the approximate range of from about 2 to about 12 minutes, more preferably from about 2 to about 5 minutes, and most preferably about 3 minutes. The starting blood temperature, and the rate at which it can be warmed or cooled to a predetermined temperature, tends to vary from subject to subject. Warming is suitably by use of one or more infrared lamps placed adjacent to the aliquot container. Other methods of warming can also be adopted.

**[0022]** As noted, it is preferred to subject the aliquot of blood to a mechanical stressor, in addition to the chosen stressor(s) discussed above. Extraction of the blood aliquot from the patient through an injection needle constitutes the most convenient way of obtaining the aliquot for further extracorporeal treatment, and this extraction procedure imparts a suitable mechanical stress to the blood aliquot. The mechanical stressor may be supplemented by subsequent processing, for example the additional mechanical shear stress caused by bubbling as the oxidative stressor is applied.

**[0023]** In the practice of the preferred process of the present invention, the blood aliquot may be treated with the heat, UV light and oxidative environment stressors using an apparatus of the type described in aforementioned U.S. Pat. No. 4,968,483 to Müller et al. The aliquot is placed in a suitable, sterile container, which is fitted into the machine. A UV-permeable container is used and the UV lamps are switched on for a fixed period before the other stressors are applied, to allow the output of the UV lamps to stabilize. When a temperature stressor is also used, the UV lamps are typically on while the temperature of the aliquot is adjusted to the predetermined preferred value, e.g.  $42.5 \pm 1^\circ \text{C}$ . Four UV lamps are suitably used, placed around the container. The oxidative stressor is then applied.

**[0024]** In the preferred method of the invention, a mammalian patient under treatment for an IFN- $\gamma$  mediated disorder or an IL-6 mediated disorder is given one or more courses of treatments, each course of treatment comprising the administration to a mammalian subject of one or more

(e.g. one to six or one to twelve) aliquots of mammalian blood modified as discussed above.

**[0025]** For optimum effectiveness of the treatment, it is preferred that no more than one aliquot of modified blood be administered to the subject per day, in one or more injection sites, and that the maximum rest period between any two consecutive aliquots during the course of treatment be no greater than about 21 days. As used herein, the term "rest period" is defined as the number of days between consecutive aliquots or consecutive courses of treatment on which no aliquots of modified blood are administered to the subject.

**[0026]** Therefore, except where aliquots are administered to the subject on consecutive days, a rest period of from 1 to 21 days is provided between any two aliquots during the course of treatment. Moreover, at least one of the rest periods during the course of treatment preferably has a length of about 3 to 15 days.

**[0027]** Although it may be sufficient to administer only one course of treatment as described above to the subject, it may be preferred in some circumstances to administer more than one course of treatment, or to follow the above-described course of treatment by periodic "booster" treatments, if necessary, to maintain the desired effects of the present invention. For example, it may be preferred to administer booster treatments at intervals of 1 to 4 months following the initial course of treatment, or to administer a second course of treatments to the subject following a rest period of several weeks or months.

**[0028]** In view of the fact that the process of the invention described above leads to a significant decrease in the expression and/or activity of the inflammatory cytokine IL-6, the invention is particularly indicated for prophylaxis or alleviation of chronic fatigue syndrome (CFS) in human patients. Whilst the etiology of CFS remains contentious, there is a general consensus that IL-6 plays a role in CFS, either as a result of abnormal levels of IL-6 in the patient or abnormal sensitivity to IL-6 on the part of the patient. See, for example, Gupta S., et. al., *J. Psychiatr. Res.* 31(1): 149-156, 1997; Cannon J. G. et.al., *J. Clin.Immunol.* 19(6): 414-421, 1999; and Pall M. L., *Med. Hypotheses* 54(1): 115-25, 2000. Although excessive levels of and/or excessive sensitivity to IL-6 are almost certainly not the only factors controlling CFS in a patient, they are at least a significant contributing factor, and the process and composition of the invention whereby IL-6 is downregulated accordingly shows potential in successful alleviation of this disorder.

**[0029]** The invention is further illustrated and described with reference to the following specific example, comprising animal studies conducted in an approved manner. The examples are offered for purposes of illustrating the invention and should not be construed as a limitation.

#### EXAMPLE

**[0030]** As a measure of the effect of the process of the present invention on inflammation resulting from T cell secretions, a contact hypersensitivity (CHS) test was used, according to approved animal experimentation procedures, using the method described by Kondo et. al., *Br J.Dermatol.* 131:354-359, 1994, with minor variations. The disclosure thereof is incorporated herein by reference. Briefly, to

induce CHS, the abdominal skin of each mouse was shaved and painted with dinitrodifluorobenzene (DNFB), the sensitizing chemical, using 25  $\mu$ l of 0.5% DNFB in a 4:1 acetone:olive oil solution. This sensitization was applied to four groups of five Balb/c mice. In addition, a measure of the responsible cytokines was made.

[0031] Whole blood was obtained from Balb/c mice by cardiac puncture through an injection needle, and treated with an anti-coagulant. An aliquot of this anticoagulated blood was subjected to the process described herein, to obtain treated blood. The remainder was left untreated, for use in control experiments. Since the Balb/c mice used were genetically identical, the administration of the treated blood to others of the group is equivalent to administration of autologous blood.

[0032] To obtain treated blood, the selected aliquot, in a sterile, UV-transmissive container, was treated simultaneously with a gaseous oxygen/ozone mixture and ultraviolet light at elevated temperature using an apparatus as generally described in aforementioned U.S. Pat. No. 4,968, 483 Müller et al. Specifically, 12 ml of citrated blood was transferred to a sterile, low density polyethylene vessel (more specifically, a Vasogen VC7002 Blood Container) for ex vivo treatment with stressors according to the invention. Using an apparatus as generally described in the aforementioned Müller et al patent (more specifically, a Vasogen VC7001 apparatus), the blood was heated to  $42.5 \pm 1^\circ$  C. and at that temperature irradiated with UV light at a wavelength of 253.7 nm, while oxygen/ozone gas mixture was bubbled through the blood to provide the oxidative environment and to facilitate exposure of the blood to UV. The constitution of the gas mixture was  $14.5 \pm 1.0 \mu$ g ozone/ml, with the remainder of the mixture comprising medical grade oxygen. The gas mixture was bubbled through the aliquot at a rate of  $240 \pm 24$  ml/min for a period of 3 minutes.

[0033] Of the 4 groups of sensitized mice, the first, control group A-1 received no treatment. The second, control group B-1, was treated with 50  $\mu$ l of physiological saline. The third, control group C-1, was sham treated, with 50  $\mu$ l of blood which had been extracted but not treated with the stressors. The fourth, test group D-1, was treated with 50  $\mu$ l of blood subjected to stressors as described above. Treatments, each involving intramuscular injection of 50  $\mu$ l of the respective liquid, started on the day of sensitization, and were repeated every day for a total of 6 days. On the same day as the last treatment, but after its administration, the animals were challenged with DNFB, by applying to one ear of each animal 10  $\mu$ l of 0.2% solution of DNFB. Inflammation due to CHS manifests itself in a swelling of the ears. Ear thickness was measured 24 hours after challenge, with a Peacock spring-loaded micrometer (Ozaki Co., Tokyo, Japan). The results were expressed as the change (from pre-challenge level) in ear thickness and represent the mean maximal increase at 24 hours after challenge.

[0034] The animals were sacrificed, and lymph nodes draining the ear which was challenged with DNFB were collected. The expression of the mRNA for the cytokines IFN- $\gamma$  and IL-6 was tested. This process of testing and analysis essentially followed the procedures described in Kondo, S., et al., *J. Immunology* 482:157, 1996. Thus the PCR products were determined by scanning of photonegatives using a laser densitometer, and the densitometric value

of each was normalized to that of the housekeeping gene B-actin. The analyses indicated that animals which had received a course of injection of blood subjected to stressors as described had significantly reduced IFN- $\gamma$  and IL-6 as compared with sham treated animals and controls, as illustrated in the accompanying Figures, in general correlation with the anti-inflammatory results.

[0035] Results shown in FIG. 2, a plot of relative amount of mRNA for IL-6 from the lymph tissue of the treated animals and the controls (saline treated), averaged across the animals of each group, are particularly noteworthy. The demonstrated reduction in IL-6 shows the potential of the process and compositions of the present invention in the prophylaxis or alleviation of chronic fatigue syndrome in human patients.

[0036] The results shown in FIG. 1, namely the reduction in the secretion of IFN $\gamma$  from cells as a result of the process of the invention, suggest another therapeutic use of the present invention, namely in association with chemotherapeutic or radiation therapy of malignancies such as lymphomas. It is known that malignant cells in lymphomas such as chronic lymphocytic leukemia (CLL) secrete excessive amounts of IFN- $\gamma$ , which then acts as protectant for the malignant cells against apoptosis inducing agents such as chemotherapeutic chemical agents and radiation treatments commonly adopted to treat the lymphomas. Inhibition of secretion of this cytokine from malignant cells accordingly renders them more susceptible to subsequent chemotherapeutic or radiation therapy. Another aspect of the present invention accordingly provides a process in which a mammalian patient undergoing or awaiting chemotherapy and/or radiation for a malignancy such as a lymphoma is given one or more courses of treatments of stressed mammalian blood cells as described above, to render the patient's malignancy more susceptible to chemotherapeutic or radiation therapy.

1. A method for treatment or prophylaxis of an inflammatory disease condition in a patient mediated by excess inflammatory cytokine production and/or abnormal sensitivity of the patient to one or more inflammatory cytokines, said cytokines being selected from the group consisting of IFN- $\gamma$  and IL-6, which method comprises administering to the patient an effective amount of stressed mammalian blood cells wherein said stressed mammalian blood cells have been extracorporeally subjected to at least one stressor selected from oxidative conditions and ultraviolet radiation.

2. A method for treatment or prophylaxis of an inflammatory disease condition in a patient mediated by excess IL-6 production and/or abnormal sensitivity of the patient to IL-6, which method comprises administering to the patient an effective amount of stressed mammalian blood cells wherein said stressed mammalian blood cells have been extracorporeally subjected to at least one stressor selected from oxidative conditions and ultraviolet radiation.

3. The method of claim 2 wherein the disease condition is chronic fatigue syndrome.

4. The method of claim 3 wherein the stressed mammalian blood cells have been extracorporeally subjected to both oxidative conditions and ultraviolet radiation simultaneously.

5. The method of claim 4 wherein the stressed mammalian blood cells have additionally been extracorporeally subjected to heat stress simultaneously with subjection to both oxidative conditions and ultraviolet radiation.



6. The method of claim 5 wherein the oxidative conditions comprise bubbling a gaseous mixture of medical grade oxygen and ozone through the blood, for a period of from about 0.5 minutes to about 60 minutes.

7. The method of claim 6 wherein the gaseous mixture has an ozone content of from about 0.1 to about 100  $\mu\text{g/ml}$ .

8. The method of claim 7 wherein the UV stressor is UV-C radiation.

9. The method of claim 8 wherein the temperature stressor is a temperature in the range from about 40 to about 55° C.

10. The method of claim 9 wherein the stressed mammalian blood cells comprise a volume of whole blood of from about 0.1 to about 400 mls.

11. A process of decreasing the expression of one or more of the inflammatory cytokines IFN- $\gamma$  and IL-6 from cells in a mammalian patient, which comprises administering to the patient an effective amount of stressed mammalian blood cells, said stressed cells having been extracorporeally subjected to at least one stressor selected from oxidative stress and ultraviolet radiation.

\* \* \* \* \*



US 20020150560A1

(19) **United States**

(12) **Patent Application Publication**  
**Sauder et al.**

(10) **Pub. No.: US 2002/0150560 A1**

(43) **Pub. Date: Oct. 17, 2002**

(54) **TREATMENT OF IL-10 DEFICIENCIES**

(30) **Foreign Application Priority Data**

(76) Inventors: **Daniel Sauder**, Toronto (CA); **Arkady Mandel**, North York (CA); **Anthony Bolton**, Derbyshire (GB)

May 11, 2000 (CA) ..... 2,308,105

**Publication Classification**

Correspondence Address:

**BURNS DOANE SWECKER & MATHIS L L P**  
**POST OFFICE BOX 1404**  
**ALEXANDRIA, VA 22313-1404 (US)**

(51) **Int. Cl.<sup>7</sup>** ..... **A61K 45/00**; A61K 33/00

(52) **U.S. Cl.** ..... **424/93.7**; 604/506; 424/600

(57) **ABSTRACT**

(21) Appl. No.: **10/030,418**

(22) PCT Filed: **May 11, 2001**

(86) PCT No.: **PCT/CA01/00679**

Mammalian disorders associated with a deficiency in the cytokine interleukin-10 (IL-10) can be alleviated by stimulating in vivo secretion and/or activity of IL-10 in the patient's blood or tissues by application of external stimulus.

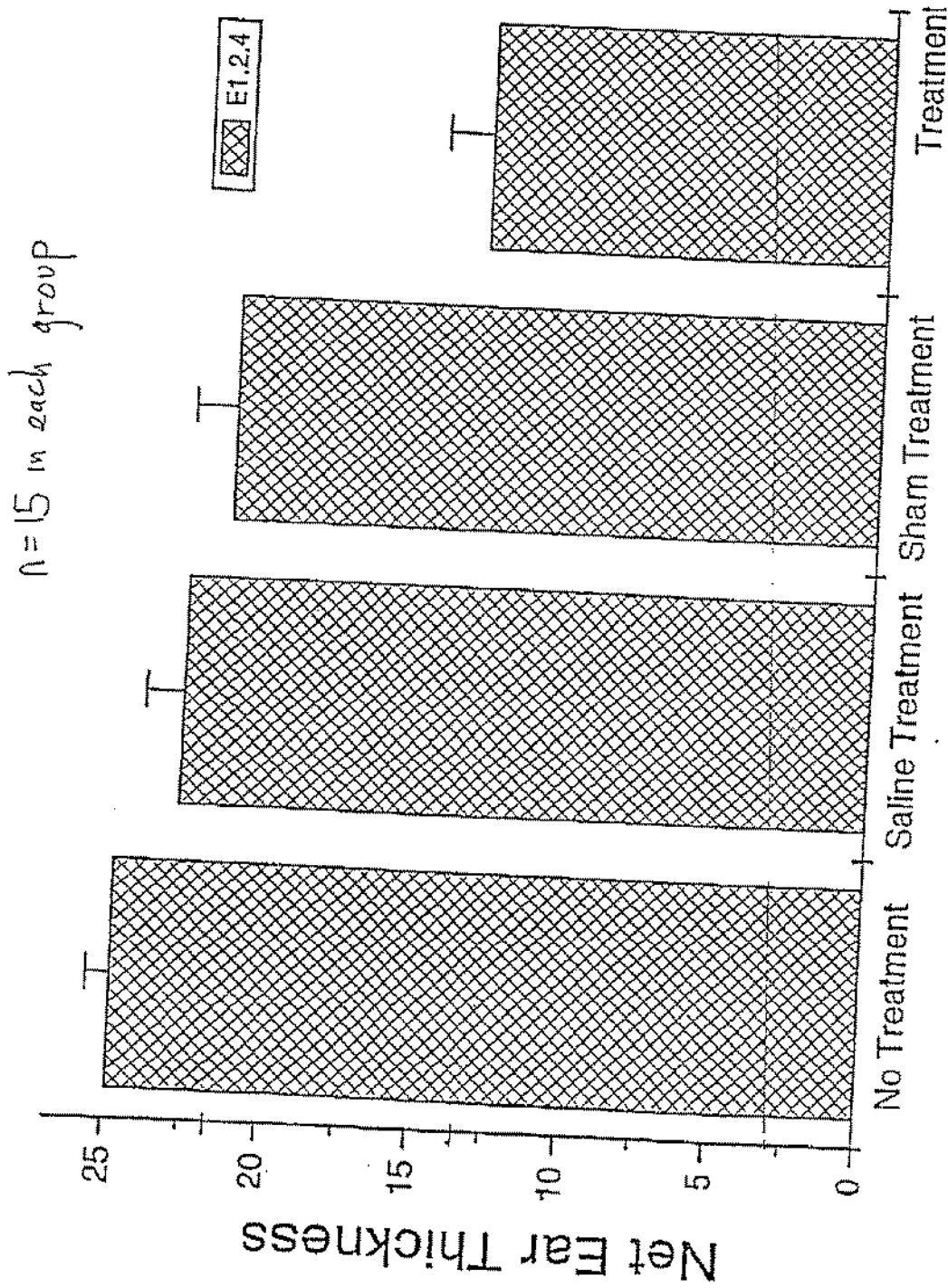


Fig. 1 Treatments

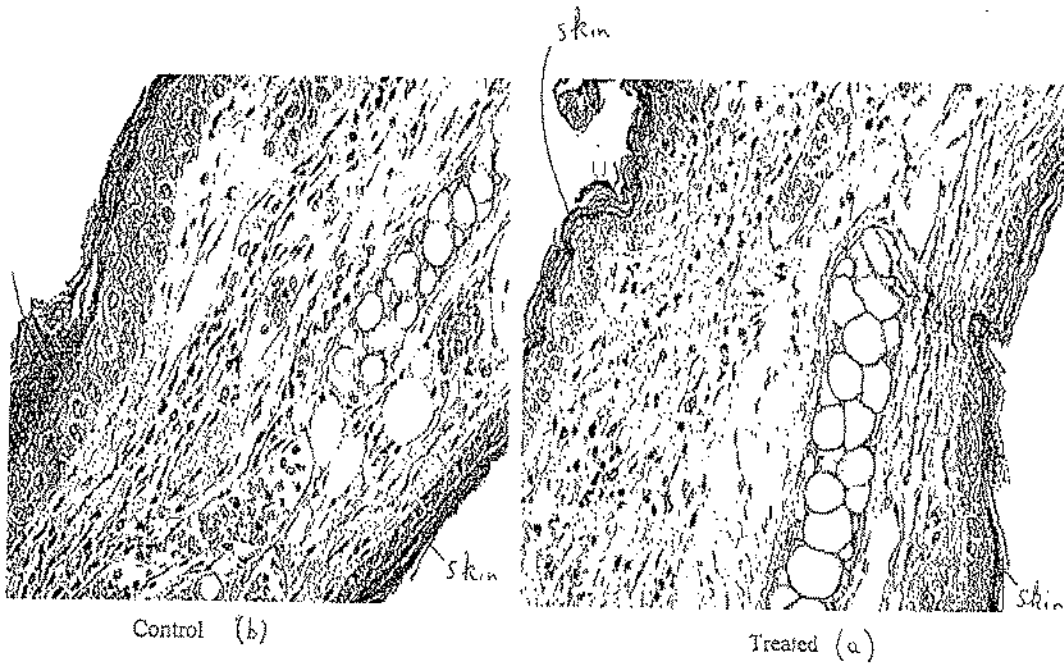


FIG. 2

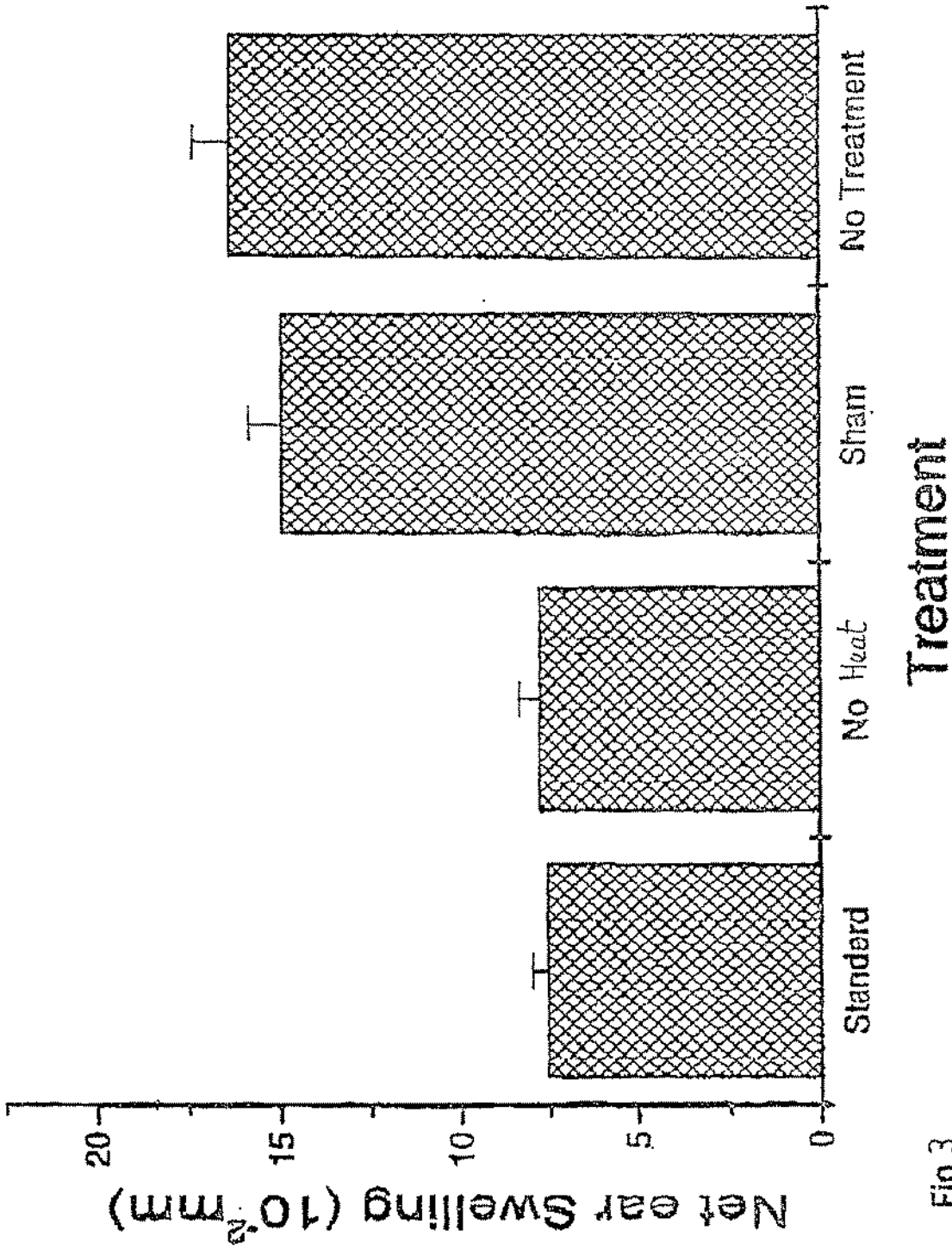


Fig 3

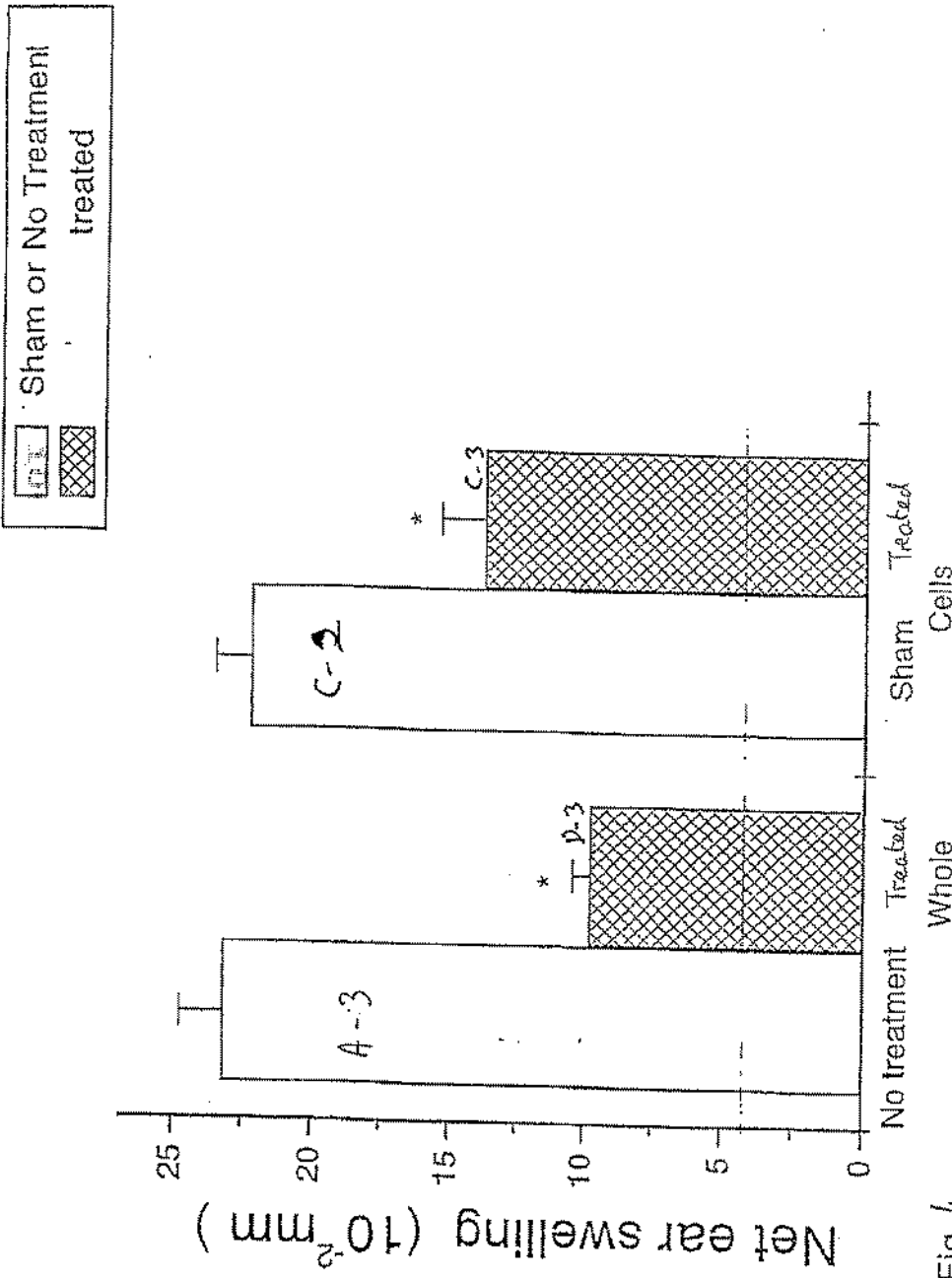


Fig 4

Fragment \* P<0.05 vs Sham or no TREATMENT

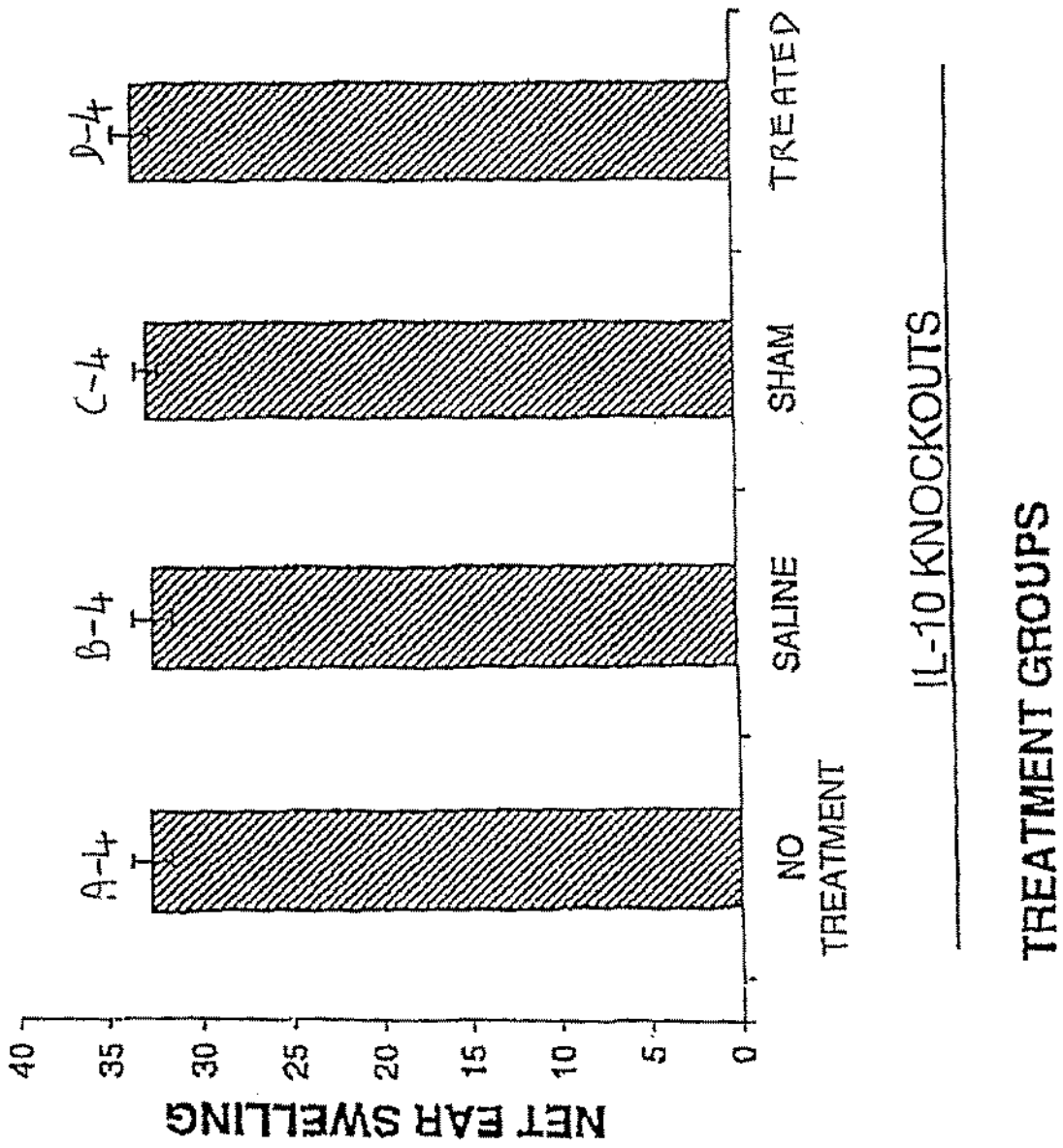


FIG. 5

## TREATMENT OF IL-10 DEFICIENCIES

### FIELD OF THE INVENTION

[0001] This invention relates to the cytokine interleukin-10 (hereafter IL-10), and methods for the treatment or prophylaxis of mammalian disorders associated with IL-10 deficiency.

### BACKGROUND OF THE INVENTION AND PRIOR ART

[0002] It is known that IL-10, originally described as cytokine synthesis inhibitory factor, plays a role in suppressing immune and inflammatory responses in the mammalian body, by inhibiting the production of pro-inflammatory cytokines. A deficiency of IL-10 results in the development of a number of significant inflammatory events including ischemia-reperfusion injury, and has been implicated in autoimmune diseases such as psoriasis and pemphigus. It has been reported to be a Th2-derived cytokine that inhibits the cytokine release by Th1 cells (see Biorencino et al., J. Exp. Med. 170: 3081-2095, 1989). Studies of the biologic activities of IL-10 in vitro have shown that IL-10 inhibits production of cytokines at both mRNA and protein levels by mouse Th1 clones stimulated by antigen or CD3 antibody in the presence of macrophages (see, again, the above cited paper by Biorencino et al.).

[0003] Kondo, McKenzie and Sauder, "The Journal of Investigative Dermatology," Vol. 103, 1994, pages 811-814 have reported that IL-10 application suppresses interferon gamma mRNA up-regulation in challenged skin, suggesting that IL-10 significantly modifies the elucidation of allergic contact sensitivity reactions.

[0004] The administration of exogenous IL-10 as a therapeutic agent to treat IL-10 deficiency-associated disorders in a mammalian patient, on any significant scale, is currently unattractive. The preparation of IL-10 by chemical synthesis, or by cell cultivation and expression techniques (e.g., using recombinant DNA technologies) is prohibitively expensive.

[0005] Current treatment of pemphigus is with oral steroids, usually prednisone. Immunosuppressive drugs such as Imuran and Cytoxan are also used as adjunctive therapy to the steroid treatment. However, these drugs have serious side effects and, accordingly, treatment for pemphigus which has reduced side effects is needed.

### SUMMARY OF THE INVENTION

[0006] It has now been found that increased secretion of IL-10 can be caused in vivo, in a mammalian patient, and that such enhanced secretion of IL-10 in vivo has a beneficial, therapeutic effect on a wide variety of mammalian disorders, including, but not limited to inflammatory disorders and disorders arising from a deficient immune system or a deficient endothelial function in the patient.

[0007] One aspect of the present invention is a method for the prophylactic or therapeutic treatment of inflammatory components and inflammatory aspects of an IL-10 deficiency-mediated disease in a mammalian patient, which method comprises administering to said patient an aliquot of blood which has been treated ex vivo with at least one stressor selected from the group consisting of an oxidative

environment, thermal stress and UV light, wherein the concentration of IL-10 secreted by immune cells in the blood or tissues of said patient is increased, with an associated reduction of harmful inflammatory effects of the IL-10 deficiency-mediated disease.

[0008] In another embodiment, the method comprises (a) identifying a patient having an IL-10 deficiency-mediated disease condition, or is at risk of having an IL-10 deficiency-mediated disease condition, which has a significant inflammatory component; (b) evaluating the patient identified in (a) above to determine whether that disease condition or risk of disease condition can be effectively treated by increasing the concentration of IL-10 in the patient; and (c) if an increase in the concentration of IL-10 would be suitable for the prophylactic or therapeutic treatment of such a disease, then administering to said patient an aliquot of blood which has been treated ex vivo with at least one stressor selected from the group consisting of an oxidative environment, thermal stress and UV light.

[0009] Another aspect of the invention is a method for preventing or treating an IL-10 deficiency-associated disorder in a mammalian patient which method comprises (a) identifying a patient having an IL-10 deficiency-mediated disorder which disorder is characterized by a decreased amount of IL-10 secretion; (b) evaluating the patient to determine whether that disorder can be effectively treated by increasing the amount of IL-10 secretion; and (c) administering to the patient an effective amount of extracorporeally stressed blood to stimulate IL-10 secretion in the patient.

[0010] Yet another aspect of this invention is a method for preventing or treating an IL-10 deficiency-mediated disorder in a mammalian patient, which method comprises (a) selecting a patient having an IL-10 deficiency-mediated disorder which disorder is characterized by a decreased amount of IL-10 secretion; (b) evaluating the patient to determine whether that disorder can be effectively treated by stimulating IL-10 secreting cells; and (c) administering to the patient an effective amount of extracorporeally stressed blood to stimulate IL-10 secreting cells thereby increasing the relative proportion of IL-10 secreting cells in the mammalian patient and stimulating the secretion of IL-10.

[0011] Another aspect of the invention is a method for preventing or treating an IL-10 deficiency-mediated disorder in a mammalian patient, which method comprises (a) selecting a patient having an IL-10 deficiency-mediated disorder which disorder is characterized by a decreased amount of IL-10 activity; (b) evaluating the patient to determine whether that disorder can be effectively treated by increasing the activity of IL-10 in the patient; and (c) administering to the patient an effective amount of extracorporeally stressed blood to increase IL-10 activity in the patient.

[0012] Another aspect of the invention provides a process of increasing in vivo levels of IL-10 in a mammalian patient, by increasing the number or relative proportion of IL-10-secreting cells in the mammalian body or by increasing the amount of IL-10 secretion from IL-10-secreting cells in the mammalian body, or by increasing the activity of IL-10 secreted in the mammalian body, and thereby effecting beneficial therapeutic effects in the patient.

[0013] From another aspect, the invention provides biologically acceptable compositions of matter administrable to



a mammalian patient, and which, upon or after such administration, stimulate enhanced secretion of IL-10 in vivo in the mammalian patient, for treatment or prophylaxis of various mammalian disorders.

#### BRIEF DESCRIPTION OF THE DRAWINGS

[0014] The figures of accompanying drawings are graphical presentations of results obtained according to specific examples described below.

[0015] FIG. 1 shows a comparison of ear thickness measurement in mice following treatment as described in Example 1.

[0016] FIG. 2 is a cross section of the ear of animals treated as described in Example 1.

[0017] FIG. 3 shows a comparison of net ear swelling in mice following treatment as described in Example 2.

[0018] FIG. 4 shows a comparison of net ear swelling in mice following treatment as described in Example 3.

[0019] FIG. 5 shows a comparison of net ear swelling in mice following treatment as described in Example 4.

#### DETAILED DESCRIPTION OF THE INVENTION

[0020] This invention is directed to methods for the treatment or prophylaxis of mammalian disorders associated with IL-10 deficiency, in particular disease such as pemphigus and psoriasis. The following terms are defined with respect to this application.

[0021] "Pemphigus" is a group of autoimmune diseases characterized by the formation of watery blisters on the skin. It is an intraepidermal blistering disease characterized clinically by superficial blisters and erosions of the skin and/or mucous membranes, especially the mouth. It is currently treated with massive doses of steroids.

[0022] It is classified into three major forms: "pemphigus foliaceus," a superficial and more benign form; "pemphigus vulgaris," a deeper, more serious and more common form; and "paraneoplastic pemphigus," the rarest and most serious form which occurs most often in patients who have been diagnosed with a malignancy (cancer).

[0023] The forms have minor variants. Pemphigus foliaceus ("PF") is caused by the location of the blister just below the stratum corneum of the epidermis. Oral lesions are uncommon. Pemphigus vulgaris ("PV") patients generally present in their fifth to sixth decade, exhibiting blisters and erosions on skin and mucous surfaces. Oral lesions often precede skin lesions by a few months. The lesions appear as erosions due to the fragility of the blisters. The oral lesions can spread to the pharynx and the larynx, with resulting hoarseness, excruciating pain, and inability to eat and drink. It has a grave prognosis if not treated. Before the introduction of oral steroid treatments, mortality was 100% by 5 years, due to malnutrition, debilitation, sepsis and/or electrolyte and water loss. Paraneoplastic pemphigus patients generally exhibit sores in the mouth, lips and esophagus and skin lesions of different types occur. This form of the disease is usually unresponsive to standard steroid treatment. In some cases, surgical removal of the associated tumor can lead to improvement of the symptoms of pemphigus. Cotell,

S.; Robinson, N. D.; and Chan, L. S., *American Journal of Emergency Medicine*, (May 2000) Vol. 18, No.3, page 1, further describe the various types of pemphigus.

[0024] Toto, P., Feliciani C, Amerio P, Suzuki H, Wang B, Shivji G M, Woodley D and Sauder D N, *J. Immunol* (Jan 1, 2000) 164(1):522-9, report that pemphigus vulgaris ("PV") is characterized by antibodies to the desmosomal cadherin desmoglein-3. This work, on delineating the potential role of T-cell signalling pathways in the pathogenesis of PV, involved passive transfer experiments with PV IgG in gene targeted mutant mice. Data described therein suggests a potential role of IL-10 in PV.

[0025] The term "prophylaxis" refers to the prevention of disease or preventive treatment of a disease.

[0026] Patients having IL-10 deficiency-associated disorders can be identified by an examination of their symptoms. The presence of the visible symptoms of psoriasis or pemphigus on a patient's skin, or the presence of symptoms of inflammatory bowel disease in a patient, are evidence of IL-10 deficiency. Such identification can also be made, or confirmed, by measurement of IL-10 and IL-10 mRNA in affected tissues of the patient, in the patient's blood and/or the patient's blood cells. IL-10 measurements can be conducted by methods well known to those skilled in the art. See, for example, the aforementioned papers of Biorencino et al. and Kondo et al., page 1 hereof, and especially references cited therein. Commonly, antibody measurements are used, in plasma or tissue, as with measurements of other cytokines.

[0027] A patient thus identified as having an IL-10 deficiency-associated disorder may be evaluated to determine whether that disorder can be effectively treated by increasing the amount of in vivo IL-10 secretion, by administering IL-10 from an external source and observing the resultant effect on the patient's symptoms of this disorder. IL-10 is commercially available, at least in test quantities. It can be administered to the test patient intravenously or by local injection at the site of the disorder, as a liquid infusion in a biologically acceptable carrier.

[0028] One way to enhance IL-10 secretion is by introduction into the patient of compatible whole blood which has been extracorporeally subjected to an oxidative stress. Another is by introduction into the patient of compatible whole blood which has been subjected extracorporeally to an appropriate dose of UV radiation. Yet another is by introduction into the patient of compatible Whole blood which has been subjected extracorporeally to an oxidative stress and an appropriate dose of UV radiation simultaneously.

[0029] Still other processes are the introduction into the patient of a cellular fraction of compatible blood, optionally including platelets, which has been subjected extracorporeally to oxidative stress, or one which has been subjected to an appropriate dose of UV radiation extracorporeally, or one which has been subjected extracorporeally to both an oxidative stress and an appropriate dose of UV radiation simultaneously. In all cases it is preferred to use the patient's own blood or blood cells, for extracorporeal processing and introduction into the patient.

[0030] A preferred process of the present invention involves extraction of an aliquot of blood from a mammalian

subject (preferably a human), and treatment of the aliquot of blood or a separated cellular fraction thereof *ex vivo*, simultaneously or sequentially, with the oxidative stress and UV radiation. Then it is injected back into the same subject. Preferably a combination of both of the oxidative stressor and the UV radiation is used simultaneously. The result is an enhanced secretion of IL-10 in the mammalian patient.

[0031] Preferably also, the aliquot of blood is in addition subjected to mechanical stress. Such mechanical stress is suitably that applied to the aliquot of blood by extraction of the blood aliquot through a conventional blood extraction needle, or a substantially equivalent mechanical stress, applied shortly before the other chosen stressors are applied to the blood aliquot. This mechanical stress may be supplemented by the mechanical stress exerted on the blood aliquot by bubbling gases through it, such as ozone/oxygen mixtures, as described below. Optionally also, a temperature stressor may be applied to the blood aliquot, simultaneously or sequentially with the other stressors, i.e., a temperature at, above or below body temperature.

[0032] The terms "aliquot," "aliquot of blood" or similar terms used herein include whole blood, separated cellular fractions of the blood including platelets, separated non-cellular fractions of the blood including plasma, plasma components and combinations thereof. Preferably, in human patients, the volume of the aliquot is up to about 400 ml, preferably from about 0.1 to about 100 ml, more preferably from about 1 to about 15 ml, even more preferably from about 8 to about 12 ml, and most preferably about 10 ml. When a cellular fraction is used instead of whole blood, the aliquot should contain the number of blood cells which would ordinarily be contained in whole blood of the aforementioned volumes, e.g.,  $10^5$ - $10^{12}$ . The effect of the combination of stressors is to modify the blood, and/or the cellular or non-cellular fractions thereof, contained in the aliquot. The modified aliquot is then re-introduced into the subject's body by any suitable method, most preferably intramuscular injection, but also including subcutaneous injection, intraperitoneal injection, intra-arterial injection, intravenous injection and oral administration.

[0033] The optionally applied temperature stressor either warms the aliquot being treated to a temperature above normal body temperature or cools the aliquot below normal body temperature. The temperature is selected so that the temperature stressor does not cause excessive hemolysis in the blood contained in the aliquot and so that, when the treated aliquot is injected into a subject, the desired effect will be achieved. Preferably, the temperature stressor is applied to that the temperature of all or a part of the aliquot is up to about 55° C., and more preferably in the range of from about -5° C. to about 55° C.

[0034] In some preferred embodiments of the invention, the temperature of the aliquot is raised above normal body temperature, such that the mean temperature of the aliquot does not exceed a temperature of about 55° C., more preferably from about 40° C. to about 50° C., even more preferably from about 40° C. to about 44° C., and most preferably about 42.5±1° C.

[0035] In other preferred embodiments, the aliquot is cooled below normal body temperature such that the mean temperature of the aliquot is within the range of from about

4° C. to about 36.5° C., more preferably from about 10° C. to about 30° C., and even more preferably from about 15° C. to about 25° C.

[0036] The oxidative stressor can be the application to the aliquot of solid, liquid or gaseous oxidizing agents. Chemical oxidants such as hydrogen peroxide can be used. Preferably, it involves exposing the aliquot to a mixture of medical grade oxygen and ozone gas, most preferably by applying to the aliquot medical grade oxygen gas having ozone as a component therein. The ozone content of the gas stream and the flow rate of the gas stream are preferably selected such that the amount of ozone introduced to the blood aliquot, either on its own or in combination with one of the other stressors, does not give rise to excessive levels of cell damage, and so that, when the treated aliquot is injected into a subject, the desired effect will be achieved. Suitably, the gas stream has an ozone content of up to about 300 µg/ml, preferably up to about 100 µg/ml, more preferably about 30 µg/ml, even more preferably up to about 20 µg/ml, particularly preferably from about 10 µg/ml to about 20 µg/ml, and most preferably about 14.5±1.0 µg/ml. The gas stream is suitably supplied to the aliquot at a rate of up to about 2.0 liters/min, even more preferably up to about 0.33 liters/min, and most preferably about 0.24±0.024 liters/min. The lower limit of the flow rate of the gas stream is preferably not lower than 0.01 liters/min, more preferably not lower than 0.1 liters/min, and even more preferably not lower than 0.2 liters/min.

[0037] The ultraviolet light, which may also be regarded as a stressor, is suitably applied by irradiating the aliquot under treatment from a source of UV light. Preferred UV sources are UV lamps emitting UV-C band wavelengths, i.e. at wavelengths shorter than about 280 nm. Ultraviolet light corresponding to standard UV-A (wavelengths from about 315 to about 400 nm) and UV-B (wavelengths from about 280 to about 315) sources can also be used. As in the case of the oxidative stressor, the UV dose should be selected, on its own or in combination of the other chosen stressor(s), so that excessive amounts of cell damage do not occur, and so that, when the treated aliquot is injected into a subject, the desired effect will be achieved. For example, an appropriate dosage of such UV light, can be obtained from up to eight lamps arranged to be exposed to the sample container holding the aliquot, operated at an intensity to deliver a total UV light energy at 253.7 nm at the surface of the blood of from about 0.025 to about 10 joules/cm<sup>2</sup>, preferably from about 0.1 to about 3.0 joules/cm<sup>2</sup>. Such a treatment, applied in combination with the oxidative environment stressor, provides a modified blood aliquot which is ready for injection into the subject, to cause enhanced levels of IL-10 to be generated *in vivo* in the subject.

[0038] It is preferred to subject the aliquot to the oxidative environment stressor, the UV light stressor and the temperature stressor simultaneously, following the subsection of the aliquot to the mechanical stress, e.g. by extraction of the blood from the patient. Thus, the aliquot may be maintained at a predetermined temperature above or below body temperature while the oxygen/ozone gas mixture is applied thereto and while it is irradiated with ultraviolet light.

[0039] The time for which the aliquot is subjected to the stressors is normally within the time range of from about 0.5 minutes up to about 60 minutes. The time depends to some

extent upon the chosen combination of stressors. When UV light is used, the intensity of the UV light may affect the preferred time. The chosen temperature level may also affect the preferred time. When oxidative environment in the form of a gaseous mixture of oxygen and ozone applied to the aliquot is chosen as one of the two stressors, the concentration of the oxidizing agent and the rate at which it is supplied to the aliquot may affect the preferred temperature. Some experimentation to establish optimum times may be necessary on the part of the operator, once the other stressor levels have been set. Under most stressor conditions, preferred times will be in the approximate range of from about 2 to about 5 minutes, more preferably about 3 minutes. The starting blood temperature, and the rate at which it can be warmed or cooled to a predetermined temperature, tends to vary from subject to subject. Warming is suitably by use of one or more infrared lamps placed adjacent to the aliquot container. Other methods of warming can also be adopted.

[0040] As noted, it is preferred to subject the aliquot of blood to a mechanical stressor, as well as the chosen stressor(s) discussed above. Extraction of the blood aliquot from the patient through an injection needle constitutes the most convenient way of obtaining the aliquot for further extracorporeal treatment, and this extraction procedure imparts a suitable mechanical stress to the blood aliquot. The mechanical stress may be supplemented by subsequent processing, for example the additional mechanical shear stress caused by bubbling as the oxidative stressor is applied.

[0041] In the practice of the preferred process of the present invention, the blood aliquot may be treated with the heat, UV light and oxidative environment stressors using an apparatus of the type described in aforementioned U.S. Pat. No. 4,968,483 to Mueller. The aliquot is placed in a suitable, sterile container, which is fitted into the machine. A UV-permeable container is used and the UV lamps are switched on for a fixed period before the other stressor is applied, to allow the output of the UV lamps to stabilize. When a temperature stressor is used in combination, the UV lamps are typically on while the temperature of the aliquot is adjusted to the predetermined value, e.g.  $42.5 \pm 1^\circ \text{C}$ . Four UV lamps are suitably used, placed around the container.

[0042] In the administration of the extracorporeally treated aliquot to the patient for the stimulation of IL-10 secretion in the patient's body, a mammalian patient is preferably given one or more courses of treatments, each course of treatment comprising the administration to a mammalian subject of one or more (e.g. one to six) aliquots of mammalian blood modified as discussed above.

[0043] The pharmaceutical compositions of this invention may optionally include a pharmaceutically acceptable excipient. Some examples of suitable excipients include sterile water, sterile saline, phosphate buffered saline, and the like.

[0044] For optimum effectiveness of the treatment, it is preferred that no more than one aliquot of modified blood be administered to the subject per day, in one or more injection sites, and that the maximum rest period between any two consecutive aliquots during the course of treatment be no greater than about 21 days. Booster treatments as described below may advantageously be used. As used herein, the term "rest period" is defined as the number of days between

consecutive aliquots or consecutive courses of treatment on which no aliquots of modified blood are administered to the subject.

[0045] Therefore, except where aliquots are administered to the subject on consecutive days, a rest period of from 1 to 21 days is provided between any two aliquots during the course of treatment. Moreover, at least one of the rest periods during the course of treatment preferably has a length of about 3 to 15 days.

[0046] Although it may be sufficient to administer only one course of treatment as described above to the subject, it may be preferred in some circumstances to administer more than one course of treatment, or to follow the above-described course of treatment by periodic "booster" treatments, if necessary, to maintain the desired effects of the present invention. For example, it may be preferred to administer booster treatments at intervals of 3 to 4 months following the initial course of treatment, or to administer a second course of treatments to the subject following a rest period of several weeks or months.

[0047] The process of the present invention increases the IL-10 level in a mammalian patient's body, both in tissue and in blood, and accordingly shows potential in the treatment and prophylaxis of a wide variety of inflammatory events and other disorders which are associated with IL-10 deficiencies.

[0048] The invention is further illustrated and described with reference to the following specific examples, comprising animal studies conducted in an approved manner. The system chosen to demonstrate the role and effect of enhanced secretion of IL-10 in mammalian patients is contact hypersensitivity, a T-cell mediated delayed-type hypersensitivity reaction in which the skin of a patient exhibits a reaction to an agent which the body has previously encountered, by contact or by inoculation. There is available an established experimental mouse model for induction and testing treatments of this disorder, as described in the following Examples. In addition genetically modified laboratory mice, specifically bred to produce no IL-10, are available commercially to permit testing of the effects of various processes on production, see Example 4 below.

[0049] Patients having IL-10 deficiency-associated disorders can be identified by an examination of their symptoms. The presence of the visible symptoms of psoriasis or pemphigus on a patient's skin, or the presence of symptoms of inflammatory bowel disease in a patient, are evidence of IL-10 deficiency. Such identification can also be made, or confirmed, by measurement of IL-10 and IL-10 mRNA in affected tissues of the patient, in the patient's blood and/or the patient's blood cells. IL-10 measurements can be conducted by methods well known to those skilled in the art—see for example the aforementioned papers of Biorencino et al. and Kondo et al., page 1 hereof, and especially references cited therein. Commonly, antibody measurements are used, in plasma or tissue, as with measurements of other cytokines.

[0050] A patient thus identified as having an IL-10 deficiency-associated disorder may be evaluated to determine whether that disorder can be effectively treated by increasing the amount of in vivo IL-10 secretion, by administering IL-10 from an external source and observing the resultant

effect on the patient's symptoms of this disorder. IL-10 is commercially available, at least in test quantities. It can be administered to the test patient intravenously or by local injection at the site of the disorder, as a liquid infusion in a biologically acceptable carrier.

#### EXAMPLE 1

[0051] The effectiveness of the treatment according to a preferred embodiment of the present invention, on contact hypersensitivity (CHS), was assessed on laboratory mice, according to approved animal experimentation procedures, using the method described by Kondo et al., "Lymphocyte function associated antigen-1 (LFA-1) is required for maximum elicitation of allergic contact dermatitis" *Br J. Dermatol.* 131:354-359, 1994, with minor variations. The disclosure thereof is incorporated herein by reference. Briefly, to induce CHS, the abdominal skin of each mouse was shaved and painted with dinitrofluorobenzene DNFB, the sensitizing chemical, using 25  $\mu$ l of 0.5% DNFB in 4:1 acetone:olive oil solution. This sensitization was applied to four groups of five Balb C mice.

[0052] Whole blood was obtained from Balb/c mice, by extraction from a main artery through an injection needle, and treated with an anti-coagulant. An aliquot of this was subjected to the process of a preferred embodiment of the invention, to obtain treated blood. The remainder was left untreated, for use in control experiments. Since these mice are genetically identical, the administration of the treated blood to others of the group is equivalent to administration of the treated blood to the donor animal.

[0053] To obtain treated blood, the selected aliquot, in a sterile, UV-transmissive container, was treated simultaneously with a gaseous oxygen/ozone mixture and ultraviolet light at elevated temperature using an apparatus as generally described in aforementioned U.S. Pat. No. 4,968,483 Mueller et al. Specifically, 10 ml of citrated blood was transferred to a sterile, low density polyethylene vessel (more specifically, a Vasogen VC7002 Blood Container) for ex vivo treatment with stressors according to the invention. Using an apparatus as described in the aforementioned Mueller patent (more specifically, a Vasogen VC7001 apparatus), the blood was heated to  $42.5 \pm 1^\circ$  C. and at that temperature irradiated with UV light principally at a wavelength of 253.7 nm, while oxygen/ozone gas mixture was bubbled through the blood to provide the oxidative environment and to facilitate exposure of the blood to UV. The constitution of the gas mixture was  $14.5 \pm 1.0 \mu$ g ozone/ml, with the remainder of the mixture comprising medical grade oxygen. The gas mixture was bubbled through the aliquot at a rate of  $240 \pm 24$  ml/min for a period of 3 minutes.

[0054] Of the 4 groups of sensitized mice, the first, control group A-1 received no treatment. The second, control group B-1, was treated with physiological saline, 50  $\mu$ l. The third, control group C-1, was sham treated, with 50  $\mu$ l of blood which had been extracted but not treated with the stressors. The fourth, test group D-1, was treated with 50  $\mu$ l of blood subjected to stressors as described above. Treatments, each involving intramuscular injection of 50  $\mu$ l of the respective liquid, started on the day of sensitization, and was repeated every day for a total of 6 days. On the same day as the last treatment, but after its administration, the animals were challenged with DNFB, by applying to the ears of each

animal 10  $\mu$ l of 0.2% solution of DNFB. Inflammation due to CHS manifests itself in a swelling of the ears. Ear thickness was measured, 24 hours after challenge, with a Peacock spring-loaded micrometer (Ozaki Co., Tokyo, Japan). The results were expressed as the change (from pre-challenge level) in ear thickness and represent the mean maximal increase at 24 hours after challenge.

[0055] The experiments were repeated two more times, using two more sets of four groups of animals, to ensure statistical significance in the results. FIG. 1 of the accompanying drawings is a graphical presentation of these results. A notable and significant reduction in ear thickness (inflammation) is to be observed with the animals treated according to this preferred process of the invention, as compared with any of the other groups. FIG. 2 of the accompanying drawings represent photographs of cross-sections of the ears of a representative treated animal of group D-1 (picture (a)) and a representative untreated group A-1 animal (picture (b)). The decreased skin thickness, and the reduced lymphocyte infiltration (lower density of dark stained cells) is readily apparent on picture (a) from the treated animal, further demonstrating a significant reduction in inflammation.

[0056] The percentage suppression when compared with the standard CHS response (no treatment, control group A-1) is 8% for the saline treatment group B-1, 14% for the sham treatment group C-1 and 46% for group D-1, treated according to the embodiment of the process of the invention.

#### EXAMPLE 2

[0057] The procedure of Example 1 was followed, using four groups of Balb/c mice, with one group receiving a blood aliquot which had been subjected to UV and ozone/oxygen bubbling, as described, but without application of the heat stressor (i.e. treated at room temperature). Thus, group A-2 received no treatment, group B-2 received untreated blood (sham treatment), group C-2 received blood treated with UV and ozone but no heat, and group D-2 received blood treated the same way as in the case of group D-1 of Example 1.

[0058] The results are presented graphically on FIG. 3, in the same manner as

[0059] FIG. 1. The result from group D-2 is marginally better than that from group C-2. The percentage suppression when compared to the standard CHS response (no treatment, group A-2) is 9% for group B-2, sham treatment, 52.5% for group C-2 and 54% for group D-2.

#### EXAMPLE 3

[0060] Whole blood was obtained from Balb/c mice. Part of the blood was subjected to UV, ozone and heat treatment as described in Example 1, and part of the blood remained untreated. Both the untreated blood and the treated blood were centrifuged to obtain a cellular fraction, and washed with saline. The treated and untreated fractions were administered to animals challenged with DNFB to develop contact hypersensitivity as described in Example 1.

[0061] Four groups of 5 mice each were injected according to the schedule of Example 1, and evaluated, as follows: Group A-3—no-treatment; Group B-3—cellular fraction of sham treated blood; Group C-3—cellular part of treated

blood; Group D-3—whole treated blood. The administrations to the mice took place just prior to sensitization with 0.5% DNFB and continued every day until challenge with 0.2% DNFB, 5 days later. A total of 6 injections were administered to each mouse.

[0062] The ear swelling of each mouse was measured 24 hours after challenge. Each experiment was repeated three times, to ensure statistical significance of the results. Net ear swelling as a measure of contact hypersensitivity and suppression thereof was calculated as  $1 - (\text{ear swelling of blood administered mouse} / \text{ear swelling of no blood administered mouse}) \times 100$ .

[0063] The results are presented graphically on FIG. 4, a summary of three experiments. A significant suppression of CHS is seen with the cellular fraction of the treated blood. There was no significant difference between the treated cellular fraction and treated whole blood.

#### EXAMPLE 4

[0064] To demonstrate the fundamental role of IL-10 secretion in the processes described above, the procedure of Example 1 was essentially repeated, using a genetic strain of laboratory mice deficient in the gene responsible for IL-10 production and secretion, i.e. IL-10 knock-out mice. These are available from laboratory animal sources, for approval experimental purposes.

[0065] Four groups each comprising five IL-10 knock-out mice were sensitized with DNFB, as described in Example 1. Whole blood was obtained from the IL-10 knock-out mice, by extraction from a main artery through an injection needle, and treated with an anti-coagulant. Aliquots of this blood were treated as described in Example 1, and other aliquots left-untreated for use as controls.

[0066] Control group A-4 received no injection. The animals of Control group B-4 were treated with physiological saline. The animals of control Group C-4 were then treated with 50  $\mu$ l of blood which had been extracted but not treated with stressors. The fourth test group of animals D-4 were treated with 50  $\mu$ l of blood subjected to stressors as described. The treatment schedules, challenge with DNFB and measurement of results via ear swelling were all as described in Example 1.

[0067] The results were shown graphically on accompanying FIG. 5. There is no difference between any of the four groups. This demonstrates that the treatment according to the invention is ineffective when applied to IL-10 knock-out mice whereas it is very effective when applied to mice of the same genetic background but expressing the IL-10 gene, so that IL-10 secretion is a key function in the treatment.

What is claimed is:

1. A method for the prophylaxis or therapeutic treatment of an IL-10 deficiency-mediated disease in a mammalian patient, which method comprises:

administering to said patient an aliquot of blood which has been treated *ex vivo* with at least one stressor selected from the group consisting of an oxidative environment, thermal stress and UV light, wherein the concentration of IL-10 secreted by immune cells in the blood or tissues of said patient is increased, with an

associated reduction of harmful inflammatory effects of the IL-10 deficiency-mediated disease.

2. The method of claim 1, wherein the oxidative environment comprises applying an oxidizing agent to the aliquot.

3. The method of claim 2, wherein the oxidizing agent comprises ozone gas, and the ozone gas is introduced into the blood aliquot in an amount which does not give rise to excessive levels of cell damage.

4. The method of claim 2, wherein the oxidizing agent comprises a mixture of ozone gas and medical grade oxygen, the ozone gas being contained in the mixture in a concentration of up to about 300  $\mu$ g/ml.

5. The method of claim 4, wherein the ozone gas is contained in the mixture in a concentration of up to about 30  $\mu$ g/ml.

6. The method of claim 5, wherein the ozone gas is contained in the mixture in a concentration of from about 13.5  $\mu$ g/ml to about 15.5  $\mu$ g/ml.

7. The method of claim 4, wherein the mixture is applied to the aliquot at a flow rate of up to about 0.33 liters/min.

8. The method of claim 7, wherein the mixture is applied to the aliquot at a flow rate of from about 0.21 liters/min to about 0.27 liters/min.

9. The method of claim 1, wherein the electromagnetic emission comprises ultraviolet light having one or more UV-C band wavelengths.

10. The method of claim 1, wherein the temperature to which the aliquot is cooled or heated is a temperature which does not result in substantial hemolysis of the blood in the aliquot.

11. The method of claim 1, wherein the temperature stressor is applied so that the temperature of at least part of the aliquot is in the range of from about  $-5^{\circ}$  C. to about  $55^{\circ}$  C.

12. The method of claim 1, wherein the mean temperature of the blood in the aliquot is in the range of from about  $37^{\circ}$  C. to about  $44^{\circ}$  C.

13. The method of claim 1, wherein the mean temperature of the blood in the aliquot is in the range of from about  $0^{\circ}$  C. to about  $36.5^{\circ}$  C.

14. The method of claim 1, wherein the mean temperature of the blood in the aliquot is in the range of from about  $10^{\circ}$  C. to about  $30^{\circ}$  C.

15. The method of claim 1, wherein the temperature is in the range of from about  $37^{\circ}$  C. to about  $55^{\circ}$  C.

16. The method of claim 15, wherein the temperature is  $42.5 \pm 1^{\circ}$  C.

17. The method of claim 1, wherein the volume of the aliquot is up to about 400 ml.

18. The method of claim 17, wherein the volume of the aliquot is about 10 ml.

19. The method of claim 17, wherein the volume of the aliquot is about 2 ml.

20. The method of claim 1, wherein the aliquot is subjected to the stressors for a period of up to about 60 minutes.

21. The method of claim 20, wherein the aliquot is subjected to the stressors for a period of about 3 minutes.

22. The method of claim 1, wherein the blood is administered to the mammal by a method suitable for vaccination selected from the group consisting of intra-arterial injection, intramuscular injection, intravenous injection, subcutaneous injection, intraperitoneal injection, and oral, nasal or rectal administration.

**23.** The method of claim 1, wherein all of the stressors are simultaneously administered to the aliquot.

**24.** The method of claim 1, wherein any two of the stressors are simultaneously administered to the aliquot.

**25.** The method of claim 24 wherein the mammal is a human.

**26.** The method of claim 25 wherein the IL-10 deficiency-mediated disease is pemphigus.

**27.** The method of claim 1 including the additional steps of:

(a) identifying a patient having an IL-10 deficiency-mediated disease condition, or is at risk of having an IL-10 deficiency-mediated disease condition, which has a significant inflammatory component;

(b) evaluating the patient identified in (a) above to determine whether that disease condition or risk of disease condition can be effectively treated by increasing the concentration of IL-10 in the patient; and

(c) if an increase in the concentration of IL-10 would be suitable for the prophylactic or therapeutic treatment of such a disease, then administering to said patient an aliquot of blood which has been treated *ex vivo* with at least one stressor selected from the group consisting of an oxidative environment, thermal stress and UV light.

**28.** A method for the prophylactic or therapeutic treatment of inflammatory components and inflammatory aspects of an IL-10 deficiency-mediated disease in a mammalian patient, which method comprises:

(a) identifying a patient having an IL-10 deficiency-mediated disease condition, or is at risk of having an IL-10 deficiency-mediated disease condition, which has a significant inflammatory component;

(b) evaluating the patient identified in (a) above to determine whether that disease condition or risk of disease condition can be effectively treated by increasing the concentration of IL-10 in the patient; and

(c) if an increase in the concentration of IL-10 would be suitable for the prophylactic or therapeutic treatment of such a disease, then administering to said patient an aliquot of blood which has been treated *ex vivo* with at least one stressor selected from the group consisting of an oxidative environment, thermal stress and UV light;

wherein the concentration of IL-10 secreted by immune cells in the blood or tissues of said patient is increased, with an associated reduction of harmful inflammatory effects of the IL-10 deficiency-mediated disease.

**29.** A method for preventing or treating an IL-10 deficiency-associated disorder in a mammalian patient which method comprises (a) identifying a patient having an IL-10 deficiency-mediated disorder which disorder is characterized by a decreased amount of IL-10 secretion; (b) evaluating the patient to determine whether that disorder can be effectively treated by increasing the amount of IL-10 secretion; and (c) administering to the patient an effective amount of extracorporeally stressed blood to stimulate IL-10 secretion in the patient.

**30.** A method for preventing or treating an IL-10 deficiency-mediated disorder in a mammalian patient, which method comprises (a) selecting a patient having an IL-10 deficiency-mediated disorder which disorder is characterized by a decreased amount of IL-10 secretion; (b) evalu-

ating the patient to determine whether that disorder can be effectively treated by stimulating IL-10 secreting cells; and (c) administering to the patient an effective amount of extracorporeally stressed blood to stimulate IL-10 secreting cells thereby increasing the relative proportion of IL-10-secreting cells in the mammalian patient and stimulating the secretion of IL-10.

**31.** A method for preventing or treating an IL-10 deficiency-mediated disorder in a mammalian patient, which method comprises (a) selecting a patient having an IL-10 deficiency-mediated disorder which disorder is characterized by a decreased amount of IL-10 activity; (b) evaluating the patient to determine whether that disorder can be effectively treated by increasing the activity of IL-10 in the patient; and (c) administering to the patient an effective amount of extracorporeally stressed blood to increase IL-10 activity in the patient.

**32.** The method according to claim 29, **30** or **31** wherein the extracorporeally stressed blood is compatible whole blood or blood cells.

**33.** The process of claim 32 wherein the extracorporeal stress is an oxidative stress.

**34.** The process of claim 32 wherein the extracorporeal stress is UV radiation.

**35.** The process of claim 32 wherein the extracorporeal stress comprises simultaneously applying oxidative stress and UV radiation.

**36.** A method for increasing IL-10 levels in the blood and/or tissues of a mammalian patient, which method comprises extracting an aliquot of the patient's blood, extracorporeally applying to at least the cellular portion of the aliquot at least one stressor selected from UV radiation and oxidative stress, and re-administering the resultant aliquot to the mammalian patient.

**37.** The method of claim 36 wherein both the UV radiation stressor and the oxidative stressor are extracorporeally applied to the aliquot simultaneously.

**38.** The process of claim 36 or **37** wherein the oxidative stress is bubbling of a mixture of medical grade oxygen and ozone through the aliquot.

**39.** A pharmaceutical composition for administration to a mammalian patient comprising patient-compatible IL-10 secretion-stimulating mammalian blood cells wherein the blood cells stimulate an increase in IL-10 levels in the blood and/or tissues of the mammalian patient when administered to the mammalian patient.

**40.** The pharmaceutical composition of claim 39 wherein the blood cells are extracorporeally stressed with at least stressor selected from the group consisting of oxidative stress and ultraviolet radiation stress.

**41.** A process of alleviating the symptoms of, or prophylaxes of, an IL-10 deficiency-associated disorder in mammalian patient, which comprises *in vivo* stimulation of enhanced IL-10 secretions in the mammalian patient by application to the patient of IL-10 secretions stimulating extracorporeally stressed compatible whole blood or blood cells.

**42.** A process of alleviating the symptoms of, or prophylaxes of, an IL-10 deficiency-associated disease in a mammalian patient, which comprises *in vivo* increasing the number of relative proportion of IL-10-secreting cells in the mammalian patient and stimulating IL-10 secretion there-

from, by application to the patient of IL-10 cell enhancing extracorporeally stressed compatible whole blood or blood cells.

**43.** A process of alleviating the symptoms of, or prophylaxes of, an IL-10 deficiency-associated disorder in a mammalian patient, which comprises in vivo enhancing the activity of IL-10 in the mammalian patient's body by application to the patient of IL-10 activity increasing extracorporeally stressed compatible whole blood or blood cells.

**44.** The process of claim 41, 42 or 43 wherein the extracorporeal stress is an oxidative stress.

**45.** The process of claim 41, 42 or 43 wherein the extracorporeal stress is UV radiation.

**46.** The process of claim 41, 42 or 43 wherein the extracorporeal stress is a combination of oxidative stress and UV radiation, applied extracorporeally to the whole blood or cellular fraction thereof simultaneously.

**47.** A process of increasing IL-10 levels in the blood and/or tissues of a mammalian patient, which comprises extracting an aliquot of the patient's blood, extracorporeally applying to at least the cellular portion of the aliquot at least

one stressor selected from UV radiation and oxidative stress, and re-administering the resultant aliquot to the mammalian patient.

**48.** The process of claim 48 wherein both the UV radiation stressor and the oxidative stressor are extracorporeally applied to the aliquot simultaneously.

**49.** The process of claim 47 or claim 48 wherein the oxidative stress is bubbling of a mixture of medical grade oxygen and ozone through the aliquot.

**50.** A biologically acceptable composition of matter for administration to a mammalian patient, said composition of matter comprising extracorporeally stressed compatible mammalian blood cells which have been subjected to at least one of oxidative stress and ultraviolet radiation stress, said composition of matter having the ability, upon administration to the mammalian patient, of stimulating an increase in IL-10 levels in the blood and/or tissues of the mammalian patient.

\* \* \* \* \*



US 20020155098A1

(19) **United States**

(12) **Patent Application Publication**

**Bolton et al.**

(10) **Pub. No.: US 2002/0155098 A1**

(43) **Pub. Date: Oct. 24, 2002**

(54) **METHODS FOR TREATING THE INFLAMMATORY COMPONENT OF A BRAIN DISORDER**

(76) Inventors: **Anthony E. Bolton**, Tideswell (GB);  
**Arkady Mandel**, North York (CA)

Correspondence Address:

**Gerald F. Swiss**

**BURNS, DOANE, SWECKER & MATHIS, L.L.P.**

**P.O. Box 1404**

**Alexandria, VA 22313-1404 (US)**

(21) Appl. No.: **10/115,943**

(22) Filed: **Apr. 5, 2002**

**Related U.S. Application Data**

(60) Provisional application No. 60/282,120, filed on Apr. 6, 2001.

**Publication Classification**

(51) **Int. Cl.<sup>7</sup>** ..... **A01N 63/00; A01N 65/00**

(52) **U.S. Cl.** ..... **424/93.7**

(57) **ABSTRACT**

Disclosed are methods for treating and preventing neurological disorders which have a significant inflammatory component. The methods of the present invention involve extracting blood from a patient, subjecting the blood ex vivo to at least one stressor selected from the group consisting of an oxidative environment, thermal stress and UV light, and then re-administering the blood to the patient, thereby reducing inflammation.



Figure 1

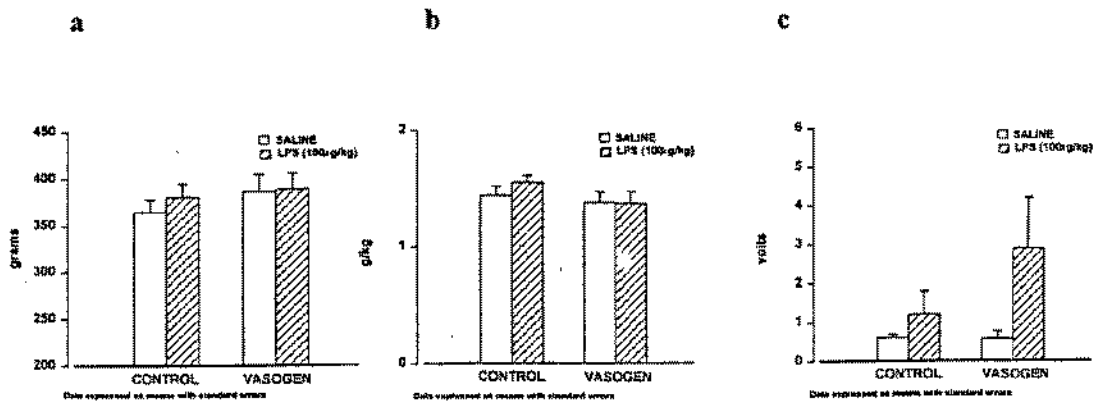


Fig 1. VasoCare™ therapy does not significantly alter bodyweight (a) or dose of urethane administered to induce anaesthesia (b) but there is an increase in the amplitude required to induce an action potential (c).

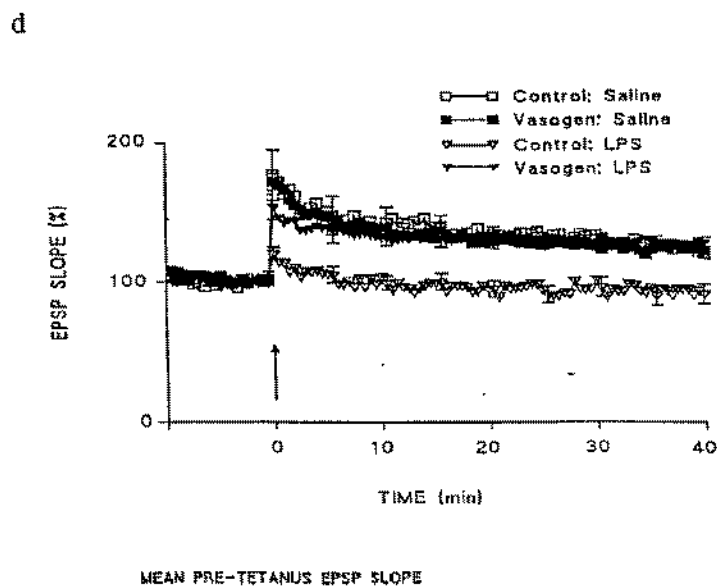


Figure 2

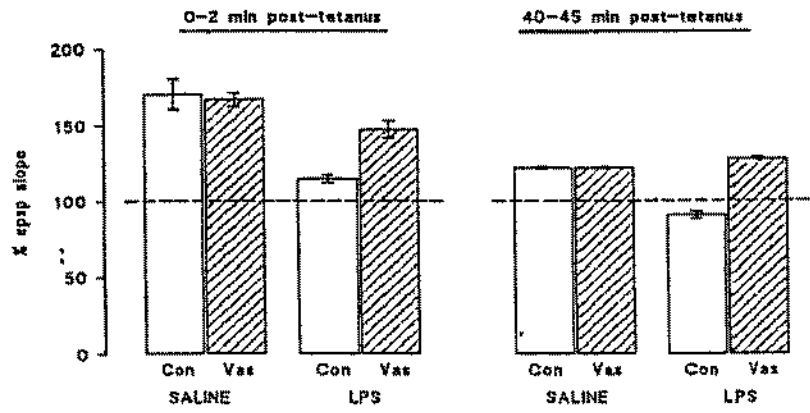
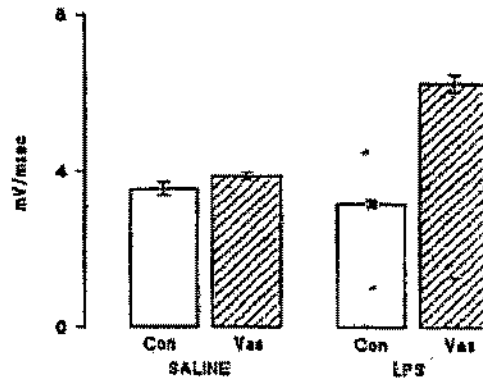
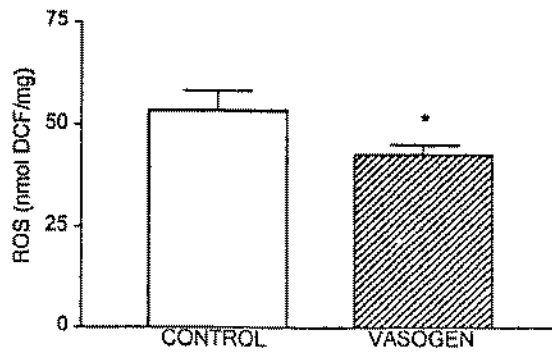


Figure 3



Data expressed as means with standard errors  
\*p<0.05, Student t-test for independent means

Figure 4

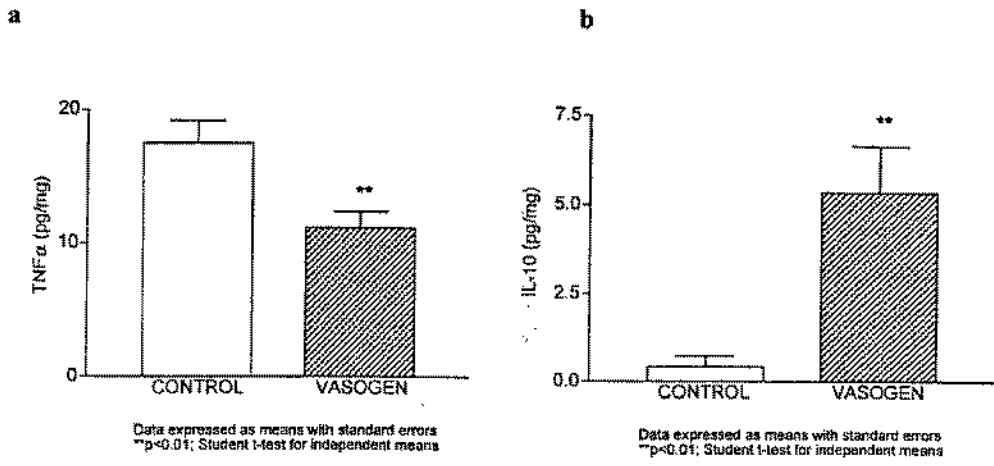
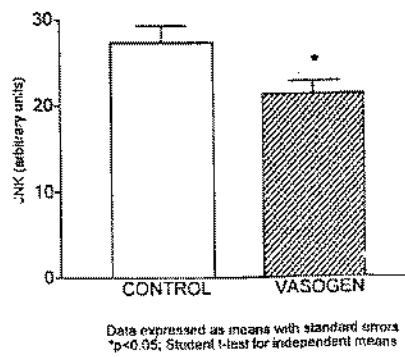
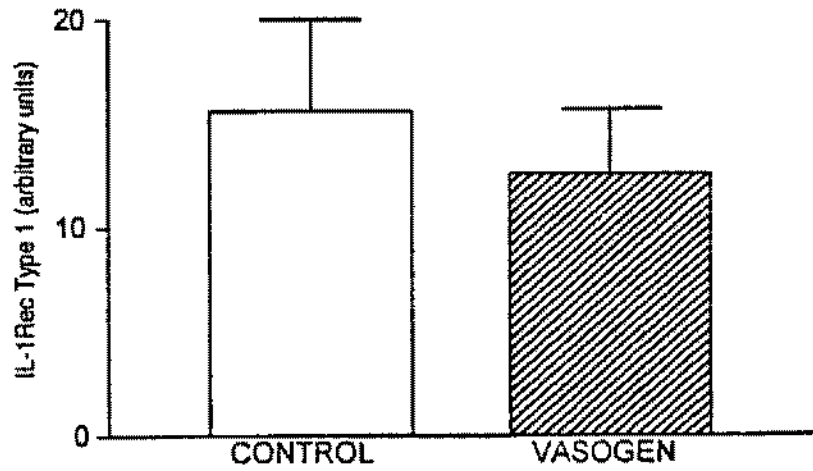


Figure 5



**Figure 6**



Data expressed as means with standard errors

## METHODS FOR TREATING THE INFLAMMATORY COMPONENT OF A BRAIN DISORDER

### REFERENCE TO RELATED APPLICATIONS

[0001] This application is based upon and claims priority from U.S. provisional patent application serial No. 60/282,120 filed Apr. 6, 2001, the disclosure of which is incorporated herein by reference, in its entirety.

### BACKGROUND OF THE INVENTION

[0002] 1. Field of the Invention

[0003] This invention is directed to methods for treating the inflammatory component of brain disorders in mammalian patients, and more particularly for treating those neurological brain disorders in which reactive oxygen species play a significant role in the underlying inflammatory pathology.

[0004] 2.State of the Art

[0005] The events that lead to neurological disorders with a significant inflammatory component (including myasthenia gravis, GBS, CIDP, and multiple sclerosis) are not clear, but the following sequential steps appear to be critical. (1) The breaking of tolerance, a process in which cytokines, molecular mimicry, or superantigens may play a role in rendering previously anergic T-cells to recognize neural autoantigens. (2) Antigen recognition by the T-cell receptor complex and processing of the antigen via the major histocompatibility complex class I or II. (3) Costimulatory factors, especially B7 and B7-binding proteins (CD28, CTLA-4) and intercellular adhesion molecule (ICAM-1) and its leukocyte function-associated (LEA)-1 ligand. (4) Traffic of the activated T cells across the blood-brain or blood-nerve barrier via a series of adhesion molecules that include selectins, leukocyte integrins (LFA-1, Mac-1, very late activating antigen (VLA)-4) and their counterreceptors (ICAM-1, vascular cell adhesion molecule (VCAM)) on the endothelial cells. (5) Tissue injury when the activated T cells, macrophages, or specific autoantibodies find their antigenic targets on glial cells, myelin, axon, calcium channels, or muscle.

[0006] In designing specific immunotherapy, the main components involved in every step of the immune response need to be considered. Targets for specific therapy in neurological disease include agents and treatments that (a) interfere or compete with antigen recognition or stimulation; (b) inhibit costimulatory signals or cytokines; (c) inhibit the traffic of the activated cells to tissues; and (d) intervene at the antigen recognition sites in the targeted organ.

[0007] Reactive oxygen species (ROS) are activated forms of oxygen, including superoxide anion ( $O_2^-$ ) and hydroxyl radicals (HO $\cdot$ ) together with hydrogen peroxide ( $H_2O_2$ ) and various unstable intermediates of lipid peroxidation. They are generated as a result of aerobic metabolism. Neuronal brain tissue is particularly susceptible to oxidative damage due its to high consumption of oxygen and its limited antioxidant defense system. Reactive oxygen species formation is thought to have an impact on synaptic plasticity, cell signaling and the aging process. An age-related increase in reactive oxygen species production has been demonstrated (Martin et al., 2000) and the accumulation of reactive

oxygen species has also been shown to be increased in the hippocampus as a consequence of peripheral LPS administration (Vereker et al., 2000a). This is mimicked by IL-1 $\beta$  administration (Vereker et al., 2000b). O'Donnell and colleagues (2000) have reported parallel changes in reactive oxygen species formation and IL-1 $\beta$  production; reactive oxygen species formation was shown to cause an increase in IL-1 $\beta$  production while IL-1 $\beta$  has the ability to induce reactive oxygen species formation thus suggesting the existence of a positive feedback loop which is potentially damaging to cells.

[0008] Increased concentrations of IL-1 $\beta$  have also been closely linked with neuronal degeneration (Mogi et al., 1996; Tenei et al., 1998).

[0009] Enhanced activity of the stress-activated kinase c-Jun N-terminal kinase (JNK) is associated with cell degeneration and death (Park et al., 1996; Maroney et al., 1998), and has been shown to be activated in the hippocampus by several agents, including hydrogen peroxide, an inducer of reactive oxygen species production, and pro-inflammatory cytokines.

[0010] Another example of a neuronal brain deficit induced by IL-1 $\beta$  and LPS, is the impairment of long term potentiation (LTP) in the hippocampus (Vereker et al 2000a; Murray & Lynch, 1998). LTP is a form of synaptic plasticity that was originally described in the hippocampus, a brain region that is particularly vulnerable to degeneration which is associated with cognitive dysfunction. On the basis of this and other observations, LTP has been proposed as a biological substrate for learning and memory (Bliss & Collingridge, 1993).

[0011] Certain neurological brain disorders such as Downs syndrome (Layton et al., Kedziora et al., Schuchmann et al.), epilepsy, brain trauma (e.g. physical damage to the brain such as concussion)(Layton et al., Wildburgur et al., Trembovler et al.) and Huntington's disease (chorea)(Green) are currently understood to involve inflammation of brain cells as a significant component of the underlying pathology of the disorder. This inflammation could be the consequence of one or more of a variety of biological processes, such as the generation of excess-amounts of inflammatory cytokines such as IL-1 $\beta$  and TNF- $\alpha$ , in the brain cells or other components of the brain tissue, perhaps associated with the presence of high concentrations of reactive oxygen species in the brain tissue, which correlates to high levels of tissue damage or exacerbation of the disease. Reactive oxygen species are one of the effectors of inflammation in tissue such as brain tissue.

[0012] Other neurological disorders which have a significant inflammatory component include Guillain-Barré syndrome (GBS), chronic inflammatory demyelinating polyneuropathy (CIDP), myasthenia gravis (MG), dermatomyositis, polymyositis, inclusion body myositis, post stroke, neurosarcooidosis, vascular dementia, closed head trauma, vasospasm, subarachnoid hemorrhage, adrenal leukocytic dystrophy (storage disorders), inclusion body dermatomyositis, minimal cognitive impairment and duchenne muscular dystrophy.

[0013] Chronic inflammatory demyelinating polyneuropathy (CIDP) is a neurological disorder characterized by slowly progressive weakness and sensory dysfunction of the

legs and arms. The disorder, which is sometimes called chronic relapsing polyneuropathy, is caused by damage to the myelin sheath of the peripheral nerves. CIDP can occur at any age and in both genders, is more common in young adults, and in men more so than women. The primary symptoms include slowly progressive muscle weakness and sensory dysfunction affecting the upper and lower extremities. Other symptoms may include fatigue; abnormal sensations including burning, numbness and/or tingling sensations (beginning in the toes and fingers); paralysis of the arms and/or legs; weakened or absent deep tendon reflexes (areflexia); and, aching pain affecting various muscle groups.

[0014] CIDP is closely related to the more common, acute demyelinating neuropathy known as Guillain-Barré syndrome (GBS). CIDP is considered the chronic counterpart of the acute disease GBS. CIDP is distinguished from GBS, chiefly by clinical course and prognosis. However, both disorders have similar clinical features, and both share the CSF albuminocytological dissociation and the pathological abnormalities of multi-focal inflammatory segmental demyelination with associated nerve conduction features reflecting demyelination.

[0015] Guillain-Barré Syndrome (GBS) is an acute predominantly motor polyneuropathy with spontaneous recovery that may lead to severe quadriplegia and requires artificial ventilation in 20-30% of patients. The diseases that underlie this syndrome have been classified as acute inflammatory demyelinating polyneuropathy (AIDP), the most common form, acute motor and sensory axonal neuropathy (AMSAN), and acute motor axonal neuropathy (AMAN). Fisher syndrome is a cranial nerve variant of GBS which characteristically results in ophthalmoplegia, ataxia and areflexia. GBS is often preceded by infection with either *Campylobacter jejuni*, which is most common, cytomegalovirus (CMV), Epstein-Barr virus or *Mycoplasma pneumoniae*.

[0016] Autoimmune myasthenia gravis (MG) is a disorder of neuromuscular transmission leading to fluctuating weakness and abnormal fatigueability. Weakness is attributed to the blockade of acetylcholine receptors (AChRs) at the neuromuscular endplate by circulating autoantibodies, followed by local complement activation and destruction of acetylcholine receptors (Stangel et al, *J. Neurol. Sci.* 153(2):203-14 (1998)). AChR is expressed on regenerating myoblasts but in normal adult muscle the AChR is only expressed at the motor endplate. In patients with early onset MG however the thymic medulla is infiltrated by lymph node-like T cells and germinal centres and there are myoblast-like myoid cells in the thymic medulla which express AChR. Therefore the presentation of the AChR antigen by these cells or by myoblasts is likely to be involved in the disease process (Curnow et al, *J. Neuroimmunol.* 115(1-2):127-134 (2001)). In studies of experimental autoimmune myasthenia gravis (EAMG) the Th2 cytokine, INF- $\gamma$ , has been shown to be involved in disease progression and has been reported to be capable of inducing the production by myoblasts of class I and II major histocompatibility antigens, AChR and ICAM-1. IL-1 has also been shown to play a role in EAMG where disruption of the IL-1 beta gene was shown to diminish acetylcholine receptor-induced responses (Garcia et al, *J. Neuroimmunol.* 120(1-2):103-11 (2001); Stegall et al, *J. Neuroimmunol.* 119(2):377-386 (2001)).

[0017] The causes of inflammatory muscle diseases dermatomyositis, polymyositis and inclusion body myositis (IBM) are unknown, but immune mechanisms are strongly implicated. Although clinically and immunopathologically distinct, these diseases share three dominant histological features: inflammation, fibrosis and loss of muscle fibres. In dermatomyositis, the endomysial inflammation and muscle fiber destruction is preceded by activation of the complement system of plasma proteins, and deposition of membranolytic attack complex on the endomysial capillaries (Dalakas, *Curr. Opin. Pharmacol.* 1(3):300-306 (2001)). There is evidence that this attack may also involve the blood vessels in the dermis (Dalakas et al, *Curr. Opin. Pharmacol.* 9(3):235-239 (1996)). Transforming growth factor beta, shown to be overexpressed in the perimysial connective tissue in dermatomyositis, is down-regulated after successful immunotherapy and reduction of inflammation and fibrosis (Dalakas, *Arch. Neurol.* 55(12):1509-1512 (1998)).

[0018] In polymyositis and IBM the disease begins with the activation of CD8<sup>+</sup> T cells. These cytotoxic T cells reach the endomysial parenchyma to recognise muscle antigen(s) associated with the upregulation of the major histocompatibility complex (MHC) I on muscle fibres. The autoinvasive T cells exhibit gene rearrangement of their T-cell receptors (TCR) and are specifically selected and clonally expanded in situ by heretofore previously unknown antigens. Muscle cells do not normally express MHC I and II but in cases of polymyositis and IBM over expression of MHC is an early event that can be detected even in areas remote from the inflammation. INF $\gamma$  and TNF $\alpha$ , cytokines that induce MHC, have been found in patients with active polymyositis (Dalakas, *Curr. Opin. Pharmacol.* 1(3):300-306 (2001)).

[0019] No signs of apoptosis have been detected in patients with inflammatory myopathies and in fact two strong anti-apoptotic molecules have recently been found to be expressed in the muscle fibers. One is the Fas-associated death domain-like IL-1-converting enzyme inhibitory protein (FLIP) and the other human IAP (inhibitor of apoptosis protein)-like protein. The result of unsuccessful apoptotic clearance of inflammatory cells is likely to be the cause of the sustained chronic cytotoxic muscle fiber damage (Vattemi et al, *J. Neuroimmunol.* 111(1-2):146-151 (2000)).

[0020] Sarcoidosis is a multisystem chronic disorder with unknown cause and a worldwide distribution. Neurosarcoidosis is a complication of sarcoidosis involving inflammation and abnormal deposits in the tissues of the nervous system. Sudden, transient facial palsy is common with involvement of cranial nerve VII. Other manifestations include aseptic meningitis, hydrocephalus, parenchymatous disease of the central nervous system, peripheral neuropathy and myopathy. Intracranial sarcoid may mimic various forms of meningitis, including carcinomatous and intracranial mass lesions such as meningioma, lymphoma and glioma, based on neuroradiological imaging. A lumbar puncture may show signs of inflammation. Elevated levels of angiotensin converting enzyme may be found in the blood or CSF. Therapy consists of immunosuppressive agents and corticosteroids (Nowak et al, *J. Neurol.* 248(5):363-372 (2001); Stern et al, *Arch. Neurol.* 42(9):909-917 (1985)).

[0021] Vascular dementia (VaD) is the general term for dementia caused by organic lesions of vascular origin, such as cerebral infarction, intracerebral haemorrhage or

ischemic changes in subcortical white matter. It is the most frequent cause of dementia after AD accounting for about 20% of cases and 50% in subjects over 80 years (Dib, *Arch. Gerontol. Geriatr.* 33(1):71-80 (2001); Parnetti et al, *Int. J. Clin. Lab. Res.* 24(1):15-22 (1994)). The clinical distinction between AD and VaD may be difficult and there are standard guidelines for research studies. VaD and AD can coexist as "mixed dementia" where the presence of cerebrovascular disease may worsen Alzheimer dementia. Traditionally AD is characterized by the insidious onset of memory loss, followed by a gradual progression to dementia in the face of normal findings on neurological examination. VaD on the other hand, is characterized by stepwise cognitive decline punctuated by episodes of stroke that are accompanied by focal deficits on neurological examination, and evidence of stroke on computed topography (CT) or magnetic-resonance imaging (Jagust, *Lancet* 358(9299):2097-2098 (2001)). It is assumed that the risk factors for stroke and vascular disease are also factors for VaD. These include hypertension, smoking, diabetes, obesity, cardiac rhythm disorders, hyperlipidaemia, hypercholesterolaemia and hyperhomocysteinaemia. The apolipoprotein E4 genotype is also considered as a risk factor for VaD, AD and ischemic stroke (Dib, *Arch. Gerontol. Geriatr.* 33(1):71-80 (2001)). Current treatments of vascular dementia include anti-platelet agents and/or surgery, and the treatment of cognitive symptoms (Parnetti et al, *Int. J. Clin. Lab. Res.* 24(1):15-22 (1994)).

[0022] Head trauma is associated with a variety of physiological and cellular phenomena such as ischemia, increased permeability of the blood-brain barrier (BBB), edema, necrosis and motor and memory dysfunction (Moor et al, *Neurosci. Lett.* 316(3):169-172 (2001); Shohami et al, *J. Neuroimmunol.* 72(2):169-177 (1997)). Ischemia caused by the initial brain injury induces a cascade of secondary events and the release of excitatory amino acids (EAA) such as glutamate and aspartate. Alteration in the levels of ions and neuromodulators lead to oxidation and cellular membrane damage and ultimately cellular death (Stahel et al, *Brain Res. Rev.* 27(3):243-256 (1998)). Experimental models for closed head injury (CHI) developed in the rat show the spatial and temporal induction of IL-1, IL-6 and TNF- $\alpha$  gene mRNA transcription along with an induction of IL-6 and TNF- $\alpha$  activity in the rat brain (Shohami et al, *J. Neuroimmunol.* 72(2):169-177 (1997)). IL-1 $\beta$  has also been shown to be released and it is the presence of these cytokines along with damage to endothelial cells that result in disruption of the BBB integrity. This disruption allows the recruitment of neutrophils into the subarachnoid space (Stahel et al (1998)).

[0023] TNF- $\alpha$  has been identified in the brain in several pathological conditions and inhibitors of TNF- $\alpha$  such as dexamethasone (HU-211) have been shown to improve neurological outcome following CHI (Shohami et al, *J. Neuroimmunol.* 72(2):169-177 (1997)).

[0024] Cerebral vasospasm is delayed onset cerebral artery narrowing in response to blood clots left in the subarachnoid space after spontaneous aneurysmal subarachnoid hemorrhage (SAH) (Ogihara et al, *Brain Res.* 889(1-2):89-97 (2001)). It is angiographically characterized as the persistent luminal narrowing of the major extraparenchymal cerebral arteries and affects the cerebral microcirculation and causes decreased cerebral blood flow (CBF) and delayed ischemic neurological deficits. A number of studies have demonstrated morphological changes in cerebral arteries

after SAH. Smooth muscle cells showed necrotic changes, such as dense bodies, degeneration of mitochondria, condensed lysosomes and dissolution of nuclear substances and the appearance of cell debris (Sobey et al, *Clin. Exp. Pharmacol. Physiol.* 25(11):867-876 (1998)). The impaired dilator and increased constrictor mechanisms that occur after SAH may be caused by oxyhaemoglobin produced by erythrocytes that inactivates NO in the subarachnoid space. Alternatively it may be due to an impaired activity of soluble guanylate cyclase resulting in reduced basal levels of cGMP in cerebral vessels and so a reduced responsiveness to NO (Ogihara et al, *Brain Res.* 889(1-2):89-97 (2001)). Production of IL-6 and IL-8 in the cerebrospinal fluid following SAH has also been demonstrated. It is thought that IL-6 may play a particular role in vasospasm as in induced vasoconstriction in a canine cerebral artery (Osuka et al, *Acta Neurochir* 140(9):943-951 (1998)).

[0025] Duchenne muscular dystrophy (DMD) is one of the most common, inherited, lethal disorders in childhood. It is an X-linked neuromuscular disease that affects 1 in 3500 males. Progressive muscle weakness begins between 2 and 5 years of age and ultimately leads to premature death by respiratory or cardiac failure during the middle to late twenties. Approximately 30% of cases are due to spontaneous mutation of the dystrophin genes while the remainder are inherited (Spencer et al, *Neuromuscul. Disord.* 11(6-7):556-564 (2001)). DMD patients therefore lack the protein dystrophin which is an essential link in the complex of proteins that connect the cytoskeleton to the extracellular matrix (Alderton et al, *Trends Cardiovascular Med.* 10(6):268-272 (2000)). Although gene therapy is the only cure for DMD it is believed that immune interventions may slow the progress of the disease. The reason for this is that there is evidence that immune cell interactions with dystrophin-deficient muscle can contribute to cell death in dystrophinopathies. It has also been shown that the population of immune cells in dystrophic muscle are not only different from those found that invade mechanically-damaged tissue; they are similar to those found in inflammatory disease such as polymyositis. Current research indicates that T cells may play a role in the pathology of dystrophin deficiency and that there may be an autoimmune component to the disease in which T cells are activated by a common antigen (Spencer et al, *Neuromuscular Disord.* 11(6-7):556-564 (2001)).

[0026] U.S. Pat. No. 5,834,030 (Bolton) describes a process for treating a patient to combat peripheral vascular disease, which comprises extracting an aliquot of the patient's blood, treating the blood aliquot extracorporeally with stressors such as an oxidative environment (ozone/oxygen gas mixture bubbled there through), incident UV light and an elevated temperature.

[0027] U.S. Pat. No. 5,980,954 (Bolton) describes similar processes for treating autoimmune diseases in mammalian patients.

[0028] It is an object of the present invention to provide a novel treatment or prophylaxis of neurological disorders which have a significant inflammatory component, such as chronic inflammatory demyelinating polyneuropathy and Guillain-Barré syndrome.

[0029] "Immune modulation therapy" as the term is used herein, is an ex vivo treatment protocol which involves exposure of autologous peripheral blood to combinations of

at least two physicochemical stressors, namely heat, oxidative stress such as ozonation and electromagnetic radiation such as ultraviolet irradiation and subsequent administration of the treated blood to the patient, suitably by intramuscular injection. There is recent evidence that such immune modulation therapy suppresses contact hypersensitivity (Shivji et al., 2000) as well as demonstrating an attenuated hyperthermic response to immobilisation stress in spontaneously hypertensive rats (Kouamé et al., 1997) thus suggesting a possible protective role. In support of this is the report that following such immune modulation therapy a reduction in the relative number of pro-inflammatory TH1 cells and an increase in TH2 cells have been observed in humans, signifying a reduction in the inflammatory response (Rabinovitch et al., 1998).

#### SUMMARY OF THE INVENTION

[0030] This invention is directed to the surprising and unexpected discovery that such immune modulation therapy can exert beneficial anti-inflammatory effects across the blood-brain barrier of a mammalian patient, apparently through a significant reduction of the accumulation of reactive oxygen species and/or a significant down-regulation of associated inflammatory cytokines such as TNF- $\alpha$ , particularly in the cortical tissue of mammals. Accordingly, the therapy is suitable for either prophylactic or therapeutic treatment of the inflammatory component of neurological brain diseases such as Downs syndrome, epilepsy, Huntington's disease and brain traumas, through mediation of the development or activity of reactive oxygen species which play a role in the development or manifestation of such inflammation.

[0031] The present invention also provides for a method for the prophylactic or therapeutic treatment of inflammatory components and inflammatory aspects of a neurological disease in a mammalian patient diagnosed with or at risk of a neurological disease, which method comprises:

[0032] administering to said patient an aliquot of blood which has been treated *ex vivo* with at least two stressors selected from the group consisting of an oxidative environment, thermal stress and electromagnetic radiation, wherein the concentration of the reactive oxygen species in neuronal cells or tissues of said patient is reduced, with associated reduction of harmful inflammatory effects therein.

[0033] From another aspect, the present invention provides a process for alleviating the symptoms of a neurological brain disorder having a significant inflammatory component associated with excess active oxygen species (reactive oxygen species and oxidative free radicals), such as Down's syndrome, Huntington's disease, epilepsy and brain traumas, which comprises scavenging of active oxygen species from the brain of a mammalian patient by administering to said patient an aliquot of blood which has been treated *ex vivo* with at least two stressors selected from the group consisting of an oxidative environment, thermal stress and electromagnetic radiation.

[0034] Accordingly, the present invention is also a method of alleviation, prophylaxis against or preconditioning to hinder the onset and progression of neurodisorders which have a significant inflammatory component, such as Guillain-Barré syndrome (GBS), chronic inflammatory demyelinating

polyneuropathy (CIDP), myasthenia gravis (MG), dermatomyositis, polymyositis, inclusion body myositis, post stroke, neurosarcoidosis, vascular dementia, closed head trauma, vasospasm, subarachnoid hemorrhage, adrenal leukocytic dystrophy (storage disorders), inclusion body dermatomyositis, minimal cognitive impairment and duchenne muscular dystrophy, wherein said method comprises treating a patient suffering from or at risk to contract such a disorder and having impaired endothelial function at the blood vessels, to improve the performance of endothelial function at the blood-brain barrier or at the blood-nerve barrier towards restoration of normal endothelial function. This represents a novel and innovative approach to the management and treatment of neurological disorders.

#### BRIEF DESCRIPTION OF THE DRAWINGS

[0035] In the accompanying drawing:

[0036] FIG. 1 is a graphical presentation of the effect of the treatment according to a preferred embodiment of the invention on the body weight of test animals, as described in the specific experimental section below;

[0037] FIG. 2 is a graphical presentation of the results of testing LPS-induced impairment of LTP described in the experimental section below;

[0038] FIGS. 3 is a graphical presentation of the measurements of reactive oxygen species accumulation described in the experimental section below;

[0039] FIG. 4 is a graphic presentation of the inflammatory cytokine TNF<sub>2</sub> measurements and anti-inflammatory cytokine IL-10 measurements in the cortex of test animals, described in the experimental section below;

[0040] FIG. 5 is a graphical presentation of the measurements of c-Jun NH<sub>2</sub>-terminal kinase (JNK) activity in the cortex of experimental animals treated as described in the experimental section below; FIG. 6 is a graphical presentation of the results of measurements of IL-1 Receptor Type 1 concentration in cortical tissue of test animals treated as described in the experimental section below.

#### THE PREFERRED EMBODIMENTS

[0041] In one of the preferred methods of this invention, a patient having a neurological disease condition with a significant inflammatory component mediated by reactive oxygen species, or at risk of developing such a brain disease condition, is first identified. Such patient may have a risk which is significantly greater than the risk in the average population, e.g. as a result of prior trauma, hereditary indication and the like. That patient is then evaluated to determine whether that disease condition or risk of disease condition can be effectively treated by reducing the concentration of reactive oxygen species. If in the opinion of the attending clinician, a reduction in the concentration of reactive oxygen species and associated reduction in neurological inflammation would be suitable for the prophylactic or therapeutic treatment of such a neurological disease, Immune modulation therapy is administered to said patient.

[0042] Accordingly, in one of its preferred aspects, this invention is directed to a method for the prophylactic or therapeutic treatment of the inflammation-associated aspects of a neurological disease having a significant inflammatory



component and mediated at least in part by reactive oxygen species, which method comprises:

[0043] (a) identifying a patient having a neurological brain disease condition or at risk of developing a neurological brain disease condition having a significant inflammatory component and mediated by reactive oxygen species;

[0044] (b) evaluating the patient identified in (a) above to determine whether that disease condition or risk of disease condition can be effectively treated by reducing the concentration of reactive oxygen species; and

[0045] (c) if a reduction in the concentration of reactive oxygen species would be suitable for the prophylactic or therapeutic treatment of such a disease, then

[0046] (d) administering to said patient an aliquot of blood which has been treated ex vivo with at least two stressors selected from the group consisting of an oxidative environment, thermal stress and electromagnetic radiation,

[0047] wherein, following such administration, the neurological brain tissue inflammation and/or the concentration of the reactive oxygen species in the neurological brain tissue of said patient is reduced.

[0048] The patient is a mammal and preferably a human.

[0049] The aliquot of blood is treated by being subjected to stressors which have been found to modify the blood. According to the present invention, the blood aliquot can be modified by subjecting the blood, or separated cellular or non-cellular fractions of the blood, or mixtures of the separated cells and/or non-cellular fractions of the blood, to stressors selected from temperature stressors, electromagnetic emissions and oxidative environments, or any combination of such stressors, simultaneously or sequentially.

#### DETAILED DESCRIPTION OF THE INVENTION

[0050] The following terms are defined with respect to this invention:

[0051] "Therapeutic treatment" refers to the treatment of a disease wherein the treatment reduces or eliminates the symptoms of that disease.

[0052] "Prophylactic treatment" or "prophylaxis" refers to the prevention or hindrance of development of disease.

[0053] The terms "aliquot," "aliquot of blood" or similar terms used herein include whole blood, separated cellular fractions of the blood including platelets, separated non-cellular fractions of the blood including plasma, and combinations thereof.

[0054] Methodology

[0055] The method of this invention provides for the prophylactic or therapeutic treatment of a neurological brain disease mediated by reactive oxygen species. In this method a patient is first identified as having such a disease condition or is at risk of having such a disease condition mediated by reactive oxygen species. The patient is then evaluated to

determine whether that disease condition or risk of disease condition can be effectively treated by reducing the concentration of reactive oxygen species. Such evaluation is made by the attending clinician based upon the disease to be treated and the progression of the disease. Such factors are well within the skill of the art. If, in the opinion of the attending clinician, a reduction in the concentration of reactive oxygen species would be suitable for the prophylactic or therapeutic treatment of such a disease, then the patient is administered an aliquot of blood which has been treated ex vivo with at least two stressors selected from the group consisting of an oxidative environment, thermal stress and electromagnetic radiation. The ex vivo treatment of the aliquot of blood is described below. The method provides a reduced concentration of the reactive oxygen species in said patient.

[0056] In this preferred method, the patient is evaluated to determine whether the neurological brain disease condition or risk of neurological brain disease condition could be effectively treated by reducing the concentration of reactive oxygen species, e.g. whether its inflammation component associated with the presence of reactive oxygen species can be effectively reduced by reducing the concentration of reactive oxygen species. In this regard, the reduction of the reactive oxygen species is reduced in the patient at the time when a reduction of reactive oxygen species effectively treats (either prophylactically or therapeutically) the disease.

[0057] The concentration of reactive oxygen species may be measured by a variety of methods known in the art. For example, one can determine them from measurements of depletion of anti-oxidative enzymes (glutathione, catalase) in the patient's blood (see Layton et. al.). An alternative is to test the serum of a patient for oxidized low density lipoproteins, using anti-oLDL ELISA immunoassay (see Wilburgur et. al.). One can also measure lipid peroxidation products such as thiobarbituric acid and its derivatives in plasma, or measure arachidonic acid oxidation products in a patient's blood.

[0058] The treated blood is administered to the mammal by a method suitable for vaccination selected from the group consisting of intra-arterial injection, intramuscular injection, intravenous injection, subcutaneous injection, intraperitoneal injection, and oral, nasal or rectal administration. Intramuscular injection is preferred.

[0059] Ex vivo Treatment of Blood

[0060] According to a preferred process of the present invention, an aliquot of blood is extracted from a mammalian subject, preferably a human, and the aliquot of blood is treated ex vivo with certain stressors, described in more detail below. The effect of the stressors is to modify the blood, and/or the cellular or non-cellular fractions thereof, contained in the aliquot. The modified aliquot is then reintroduced into the subject's body by any route suitable for vaccination.

[0061] The stressors to which the aliquot of blood is subjected ex vivo according to the method of the present invention are selected from temperature stress (blood temperature above or below body temperature), an oxidative environment and an electromagnetic emission, individually or in any combination, simultaneously or sequentially. Suitably, in human subjects, the aliquot has a volume sufficient

that, when re-introduced into the subject's body, at least partial alleviation of the reactive oxygen species mediated disorder is achieved in the subject.

[0062] Preferably, the volume of the aliquot is up to about 400 ml, preferably from about 0.1 to about 100 ml, more preferably from about 5 to about 15 ml, even more preferably from about 8 to about 12 ml, and most preferably about 10 ml, along with an anticoagulant, e.g., 2 ml sodium citrate.

[0063] It is preferred, according to the invention, to apply all three of the aforementioned stressors simultaneously to the aliquot under treatment, in order to ensure the appropriate modification to the blood. It may also be preferred in some embodiments of the invention to apply any two of the above stressors, for example to apply temperature stress and oxidative stress, temperature stress and an electromagnetic emission, or an electromagnetic emission and oxidative stress. Care must be taken to utilize an appropriate level of the stressors to thereby effectively modify the blood to alleviate the reactive oxygen species mediated disorder in the subject.

[0064] The temperature stressor warms the aliquot being treated to a temperature above normal body temperature or cools the aliquot below normal body temperature. The temperature is selected so that the temperature stressor does not cause excessive hemolysis in the blood contained in the aliquot and so that, when the treated aliquot is injected into a subject, alleviation of the reactive oxygen species mediated disorder will be achieved. Preferably, the temperature stressor is applied so that the temperature of all or a part of the aliquot is up to about 55° C., and more preferably in the range of from about -5° C. to about 55° C.

[0065] In some preferred embodiments of the invention, the temperature of the aliquot is raised above normal body temperature, such that the mean temperature of the aliquot does not exceed a temperature of about 55° C., more preferably from about 40° C. to about 50° C., even more preferably from about 40° C. to about 44° C., and most preferably about 42.5±1° C.

[0066] In other preferred embodiments, the aliquot is cooled below normal body temperature such that the mean temperature of the aliquot is within the range of from about -5° C. to about 36.5° C., more preferably from about 10° C. to about 30° C., and even more preferably from about 15° C. to about 25° C.

[0067] The oxidative environment stressor can be the application to the aliquot of solid, liquid or gaseous oxidizing agents. Preferably, it involves exposing the aliquot to a mixture of medical grade oxygen and ozone gas, most preferably by bubbling through the aliquot, at the aforementioned temperature range, a stream of medical grade oxygen gas having ozone as a minor component therein. The ozone content of the gas stream and the flow rate of the gas stream are preferably selected such that the amount of ozone introduced to the blood aliquot, either on its own or in combination with other stressors, does not give rise to excessive levels of cell damage such that the therapy is rendered ineffective.

[0068] Suitably, the gas stream has an ozone content of up to about 300 µg/ml, preferably up to about 100 µg/ml, more preferably about 30 µg/ml, even more preferably up to about 20 µg/ml particularly preferably from about 10 µg/ml to

about 20 µg/ml, and most preferably about 14.5±1.0 µg/ml. The gas stream is suitably supplied to the aliquot at a rate of up to about 2.0 liters/min, preferably up to about 0.5 liters/min, more preferably up to about 0.4 liters/min, even more preferably up to about 0.33 liters/min, and most preferably about 0.24±0.024 liters/min, at STP. The lower limit of the flow rate of the gas stream is preferably not lower than 0.01 liters/min, more preferably not lower than 0.1 liters/min, and even more preferably not lower than 0.2 liters/min.

[0069] The electromagnetic emission stressor is suitably applied by irradiating the aliquot under treatment from a source of an electromagnetic emission while the aliquot is maintained at the aforementioned temperature and while the oxygen/ozone gaseous mixture is being bubbled through the aliquot. Preferred electromagnetic emissions are selected from photonic radiation, more preferably UV, visible and infrared light, and even more preferably UV light. The most preferred UV sources are UV lamps emitting primarily UV-C band wavelengths, i.e., at wavelengths shorter than about 280 nm. Such lamps may also emit amounts of visible and infrared light. Ultraviolet light corresponding to standard UV-A (wavelengths from about 315 to about 400 nm) and UV-B (wavelengths from about 280 to about 315) sources can also be used. For example, an appropriate dosage of such UV light, applied simultaneously with the aforementioned temperature and oxidative environment stressors, can be obtained from lamps with a combined power output of from about 15 to about 25 watts, arranged to surround the sample container holding the aliquot, each lamp providing an intensity at a distance of one meter, of from about 45-65 mW/cm<sup>2</sup>. Up to eight such lamps surrounding the sample bottle, with a combined output at 253.7 nm of 15-25 watts, operated at an intensity to deliver a total UV light energy at the surface of the blood of from about 0.025 to about 10 joules/cm<sup>2</sup>, preferably from about 0.1 to about 3.0 joules/cm<sup>2</sup>, may advantageously be used. Preferably, four such lamps are used.

[0070] The time for which the aliquot is subjected to the stressors is normally within the time range of up to about 60 minutes. The time depends to some extent upon the chosen intensity of the electromagnetic emission, the temperature, the concentration of the oxidizing agent and the rate at which it is supplied to the aliquot. Some experimentation to establish optimum times may be necessary on the part of the operator, once the other stressor levels have been set. Under most stressor conditions, preferred times will be in the approximate range of from about 2 to about 5 minutes, more preferably about 3 or about 3½ minutes. The starting blood temperature, and the rate at which it can be warmed or cooled to a predetermined temperature, tends to vary from subject to subject. Such a treatment provides a modified blood aliquot which is ready for injection into the subject.

[0071] In the practice of the preferred process of the present invention, the blood aliquot may be treated with the stressors using an apparatus of the type described in U.S. Pat. No. 4,968,483 to Mueller. The aliquot is placed in a suitable, sterile, UV light-transmissive container, which is fitted into the machine. The UV lamps are switched on for a fixed period before the gas flow is applied to the aliquot providing the oxidative stress, to allow the output of the UV lamps to stabilize. The UV lamps are typically switched on while the temperature of the aliquot is adjusted to the

predetermined value, e.g.,  $42.5 \pm 1^\circ \text{C}$ . Then the oxygen/ozone gas mixture, of known composition and controlled flow rate, is applied to the aliquot, for the predetermined duration of up to about 60 minutes, preferably 2 to 5 minutes and most preferably about 3 minutes as discussed above, so that the aliquot experiences all three stressors simultaneously. In this way, blood is appropriately modified according to the present invention to achieve the desired effects.

[0072] A subject preferably undergoes a course of treatments, such individual treatment comprising removal of a blood aliquot, treatment thereof as described above and re-administration of the treated aliquot to the subject. A course of such treatments may comprise daily administration of treated blood aliquots for a number of consecutive days, or may comprise a first course of daily treatments for a designated period of time, followed by an interval and then one or more additional courses of daily treatments.

[0073] In one preferred embodiment, the subject is given an initial course of treatments comprising the administration of 4 to 6 aliquots of treated blood. In another preferred embodiment, the subject is given an initial course of therapy comprising administration of from 2 to 4 aliquots of treated blood, with the administration of any pair of consecutive aliquots being either on consecutive days, or being separated by a rest period of from 1 to 21 days on which no aliquots are administered to the patient, the rest period separating one selected pair of consecutive aliquots being from about 3 to 15 days. In a more specific, preferred embodiment, the dosage regimen of the initial course of treatments comprises a total of three aliquots, with the first and second aliquots being administered on consecutive days and a rest period of 11 days being provided between the administration of the second and third aliquots.

[0074] It may be preferred to subsequently administer additional courses of treatments following the initial course of treatments. Preferably, subsequent courses of treatments are administered at least about three weeks after the end of the initial course of treatments. In one particularly preferred embodiment, the subject receives a second course of treatment comprising the administration of one aliquot of treated blood every 30 days following the end of the initial course of treatments, for a period of 6 months.

[0075] It will be appreciated that the spacing between successive courses of treatments should be such that the positive effects of the treatment of the invention are maintained, and may be determined on the basis of the observed response of individual subjects.

#### EXAMPLES

[0076] The invention is demonstrated and illustrated by the following animal experiments, conducted on Wistar rats, according to ethically-approved procedures and protocols.

[0077] The experiments investigated the effect of pre-treatment of peripheral blood exposed to immune modulation therapy on LPS-induced impairment of LTP in rat hippocampal tissue. Preliminary studies were also carried out in cortical tissue to explore the consequence of immune modulation therapy on the accumulation of ROS, the concentration of the cytokines TNF $\alpha$  and IL-10, as well as IL-1 receptor type I, and on the activity of the stress-activated protein kinase, JNK.

#### EXPERIMENTAL PROCEDURE

##### [0078] Animals

[0079] Four groups of eight male Wistar rats (300-350 g; BioResources Unit, Trinity College Dublin, Republic of Ireland) were used in these experiments. Animals were housed in groups of four under a 12-hour light schedule, ambient temperature was controlled between 22 and 23 $^\circ \text{C}$ . and rats were maintained under veterinary supervision.

##### [0080] Treatment Protocol

[0081] Whole blood was obtained by cardiac puncture from donor rats and anticoagulated with sodium citrate (10 ml of blood+2 ml of 3.13% sodium citrate solution). The anticoagulated blood was divided into two aliquots; 2 ml to be used for sham treatment and 10 ml to undergo immune modulation treatment. For immune modulation treatment, 10 ml of anticoagulated blood was transferred to a custom-built sterile, low-density polyethylene disposable blood container (Vasogen Inc, Toronto, ON, Canada) and exposed to a combination of controlled physicochemical stress factors in a medical device (Vasogen Inc).

[0082] During processing, the temperature of the blood was raised to 42.5 $^\circ \text{C}$ ., during which time blood was exposed to UV light (maximum emission spectrum at 254 nm). When this temperature was reached, a gas mixture of 14.5 $\pm$ 1.0  $\mu\text{g}/\text{mL}$  of ozone in medical oxygen was bubbled through the blood at a flow rate of 240 $\pm$ 24 mL per min for 3 minutes, after which time the heat and UVC light sources were turned off. The foaming action caused by bubbling the gas through the blood increased the surface area exposed to the UVC light. The blood was then allowed to settle to the bottom of the blood container and was then ready to be used. Two groups of 16 rats were treated by intramuscular injection with 150  $\mu\text{L}$  of processed blood or untreated blood (sham treatment). Injections were administered 14 days, 13 days and 1 day before LPS challenge/induction of LTP.

##### [0083] Induction of LTP in Perforant Path-Granule Cell Synapses in vivo

[0084] Rats were anesthetized by intraperitoneal injection of urethane (1.5 g/kg). All rats received LPS (100  $\mu\text{g}/\text{kg}$ ) or saline, intraperitoneally and monitored for 3 h. A bipolar stimulating electrode and a unipolar recording electrode were placed in the perforant path (4.4 mm lateral to Lambda) and in the dorsal cell body region of the dentate gyrus (2.5 mm lateral and 3.9 mm posterior to Bregma), respectively, and 0.033-Hz test shocks were given for 10 min before, and 40 min after, tianic stimulation (three trains of stimuli delivered at 30-s intervals, 250 Hz for 200 ms (McGahon & Lynch, 1996)). Rats were killed by decapitation; cross-chopped slices (350 $\times$ 350  $\mu\text{m}$ ) were prepared from dentate gyri, entorhinal cortex, hippocampus and cortex and used to prepare dissociated cells (see below) or frozen separately in Krebs solution containing 10% dimethyl sulfoxide (Haan & Bowen, 1981) and stored at -80 $^\circ \text{C}$ . For analysis, slices were thawed rapidly and rinsed in fresh oxygenated Krebs solution before preparation of homogenate or the crude synaptosomal pellet P<sub>2</sub> (McGahon & Lynch, 1996).

##### [0085] Analysis of Reactive Oxygen Species Formation

[0086] The formation of reactive oxygen species was assessed by analyzing formation of the highly-fluorescent 2',7-dichlorofluorescein (DCF) from the non-fluorescent

probe, 2',7-dichlorofluorescein diacetate (DCFH-DA; Molecular Probes, USA; LeBel et al., 1992). The synaptosomal pellet, P<sub>2</sub>, prepared from cortex, was resuspended in 1 mL ice-cold 40 mM Tris buffer (pH 7.4), incubated at 37° C. for 15 min with DCFH-DA (10  $\mu$ L; final concentration 5  $\mu$ M; from a stock solution of 500  $\mu$ M in methanol) and the reaction was terminated by centrifugation at 13,000 $\times$ g for 8 min at 4° C. Pellets were resuspended in 1.5 mL of ice-cold 40 mM Tris buffer, pH 7.4, and monitored for fluorescence at 37° C. (excitation, 488 nm; emission, 525 nm). Reactive oxygen species formation was quantified from a standard curve of DCF in methanol (range 0 to 5  $\mu$ M). Protein concentration was determined (Bradford, 1976) and the results were expressed as nmol/mg protein/min.

#### [0087] Analysis of TNF $\alpha$ and IL-10 Concentration

[0088] A commercially available Enzyme-linked immunosorbent assay was used to analyze cortical TNF $\alpha$  (Biosource International Inc.) and cortical IL-10 was measured using an IL-10 Cytoset Antibody Pair (Biosource International Inc.). Each tissue was added to 1 mL of Iscove's culture medium containing 5% fetal bovine serum and a cocktail enzyme inhibitor (100 mM amino-n-caproic acid, 10 mM Na<sub>2</sub>EDTA, 5 mM Benzamidine HCl, 0.2 mM phenylmethylsulfonyl fluoride). Tissue was homogenized and centrifuged at 10,000 rpm at 4° C. for 10 min. Supernatants were removed and analyzed for TNF $\alpha$  using ELISA. Protein concentration was determined (Bradford, 1976) and the results were expressed as pg/mg protein.

#### [0089] Analysis of JNK Activity and IL-1 Receptor Type I Concentration

[0090] JNK activity and IL-1 Receptor Type I concentration was analyzed using Western Blotting technique in samples prepared from cortical tissue. Tissue homogenates were diluted to equalize for protein concentration (Bradford, 1976) and 10  $\mu$ L aliquots (1 mg/mL) were added to 5  $\mu$ L of sample buffer (0.5 mM Tris-HCl, pH 6.8, 10% glycerol, 10% SDS, 5%  $\beta$ -mercaptoethanol, 0.05% bromophenol blue, w/v) and boiled for 5 min. Samples were frozen until Western Blotting was performed. 10  $\mu$ L of each sample was loaded onto gels (10% SDS) for each analysis. Proteins were separated by application of a 32-mA constant current for 25-30 min, transferred onto nitrocellulose strips (225 mA for 75 min), and immunoblotted with the appropriate antibody. To assess JNK activity, proteins were immunoblotted with an antibody that specifically targets phosphorylated JNK (Santa Cruz Biotechnology, Inc; 1:100 in TBS and 0.1% Tween 20 containing 1% BSA) for 2 h at room temperature.

[0091] IL-1 Receptor Type I concentration was assessed by immunoblotting proteins with a rabbit polyclonal antibody raised against an epitope mapping at the carboxy terminus of IL-1RI of mouse origin (Santa Cruz Biotechnology, Inc.; 1:2000 in PBS and 0.1% Tween 20 containing 2% non-fat dried milk) for 45 min at room temperature and 45 min at 37° C. Nitrocellulose strips were washed and incubated with secondary antibody [peroxide-linked anti-mouse IgG; 1:300 dilution (Sigma) for 2 h at room temperature in the case of JNK and with HRP-linked anti-rabbit antibody; 1:2000 dilution (Amersham, UK) for 60 min at room temperature and 30 min at 37° C. in the case of IL-1 Receptor Type I. Visualization of phosphorylated JNK was achieved using SuperSignal West Dura Extended Duration Substrate (Pierce, USA). Immunoblots were immersed in

substrate for 5 min and subsequently exposed to film for 1 s. Protein complexes of IL-1 Receptor Type I were visualized by ECL detection (Amersham, UK) and immunoblots were exposed to film overnight at 4° C. In both cases films were processed using a Fuji x-ray processor. Quantification of protein bands was achieved by densitometric analysis using two software packages, Grab It (Grab It Annotating Grabber, version 2.04.7, Synotics; UVP Ltd) and Gelworks (Gelworks ID, version 2.51; UVP Ltd) for photography and densitometry, respectively. Gelworks provides a single value (in arbitrary units) representing the density of each blot.

#### [0092] Analysis of Glutamate Release

[0093] Glutamate release was assessed in the impure synaptosomal preparation, P<sub>2</sub>, obtained from dentate gyrus; either freshly-prepared tissue was used or alternatively, P<sub>2</sub> was prepared from frozen slices of dentate gyri which were obtained from rats in which electrophysiological recordings were made (McGahon and Lynch, 1996). In both cases, P<sub>2</sub> preparations were resuspended in oxygenated Krebs solution containing 2 mM CaCl<sub>2</sub> and glutamate release was assessed as described previously (McGahon et al., 1996). Briefly, synaptosomal tissue was aliquotted onto Millipore filters (0.45  $\mu$ m), rinsed under vacuum and the filtrate was discarded. Synaptosomes were then incubated in 250  $\mu$ L oxygenated Krebs solution at 37° C. for 3 min, in the presence or absence of 40 mM KCl, and filtrate was collected and stored for analysis as described (Ordonneau et al., 1991). In some experiments, synaptosomes were incubated at 37° C. for 20 min in Krebs solution containing IL-1 $\beta$  (1 ng/ml) in the presence or absence of Vasoactive Intestinal Peptide (VIP; 1  $\mu$ M). Triplicate samples (50  $\mu$ L) or glutamate standards (50  $\mu$ L; 25 nM to 1  $\mu$ M prepared in 100 mM NaH<sub>2</sub>PO<sub>4</sub> buffer, pH 8.0) were added to glutaraldehyde-coated 96-well plates, incubated for 60 min at 37° C., and washed with 100 mM NaH<sub>2</sub>PO<sub>4</sub> buffer. Ethanolamine (250  $\mu$ L; 0.1 M in 100 mM NaH<sub>2</sub>PO<sub>4</sub> 4 buffer) was used to bind unreacted aldehydes and donkey serum (200  $\mu$ L; 3% in PBS-T) was added to block non-specific binding. Samples were incubated overnight at 4° C. in the presence of anti-glutamate antibody (raised in rabbit; 100  $\mu$ L; 1:5,000 in PBS-T; Sigma, UK), washed and reacted with secondary antibody (anti-rabbit horseradish peroxidase (HRP)-linked secondary antibody; 100  $\mu$ L; 1:10,000 in PBS-T; Amersham, UK) for 60 min at room temperature. 3,3', 4,4'-Tetramethylbenzidine liquid substrate was added as chromogen and incubation continued for exactly 60 min at room temperature, at which time the reaction was stopped by H<sub>2</sub>SO<sub>4</sub> (4 M; 30  $\mu$ L). Optical densities were determined at 450 nm using a multiwell plate reader and values were calculated with reference to the standard curve, corrected for protein (Bradford, 1976) and expressed as  $\mu$ mol glutamate/mg protein.

#### [0094] Analysis of IL-1 $\beta$ Concentration

[0095] IL- $\beta$  concentration in hippocampal was analysed by ELISA (R & D Systems, UK). Antibody-coated (100  $\mu$ L; 1.0  $\mu$ g/ml final concentration, diluted in phosphate buffered saline (PBS), pH 7.3; goat anti-rat IL-1 $\beta$  antibody) 96-well plates were incubated overnight at room temperature, washed several times with PBS containing 0.05% Tween 20, blocked for 1 hour at room temperature with 300  $\mu$ L blocking buffer, (PBS, pH 7.3 containing 5% sucrose, 1% bovine serum albumin (BSA), and 0.05% NaN<sub>3</sub>). After several washes, plates were incubated with IL-1 $\beta$  standards (100  $\mu$ L;

0-1000 pg/ml in PBS containing 1% BSA) or samples (homogenized in Krebs solution containing 2 mM  $\text{CaCl}_2$ ) for 2 hours at room temperature. Samples were incubated with secondary antibody (100  $\mu\text{l}$ ; final concentration 350 ng/ml in PBS containing 1% BSA and 2% normal goat serum; biotinylated goat anti-rat IL-1 $\beta$  antibody) for 2 hours at room temperature, washed and incubated in detection agent (100  $\mu\text{l}$ ; horseradish peroxidase conjugated streptavidin; 1:200 dilution in PBS containing 1% BSA) for 20 min at room temperature. Substrate solution (100  $\mu\text{l}$ ; 1:1 mixture of  $\text{H}_2\text{O}_2$  and tetramethylbenzidine) was added, samples were incubated at room temperature in the dark for 1 hour after which time the reaction was stopped using 50  $\mu\text{l}$  1 M  $\text{H}_2\text{SO}_4$ . Absorbance was read at 450 nm, values were corrected for protein (Bradford, 1976) and expressed as pg IL-1 $\beta$ /mg protein.

#### [0096] TUNEL Staining

[0097] Dissociated cells were prepared by enzymatic and mechanical digestion of fresh hippocampal slices. Slices were incubated with collagenase (0.125%) in PBS for 30 min at room temperature, washed with PBS to terminate collagenase digestion, and then gently triturated with a glass Pasteur pipette, before passing through a nylon mesh filter to remove tissue clumps. Cells were then cytospun onto glass microscope slides, fixed with methanol and stored until use.

[0098] TUNEL (Terminal deoxynucleotidyl Transferase (TdT)-mediated dUTP Nick-End Labeling) staining, which identifies nuclei with fragmented DNA (a characteristic of apoptotic cells), was performed according to the manufacturer's instructions. Briefly, fixed cytospun cells were washed and permeabilized. Cells were equilibrated in buffer (200 mM potassium cacodylate (pH 6.6 at 25° C.), 25 mM Tris-HCl (pH 5.5 at 25° C.), 0.2 mM DTT, 0.25 mg/ml BSA, 2.5 mM  $\text{CoCl}_2$ ) for 5 min at room temperature and incubated in TdT reaction mixture (30  $\mu\text{l}$ ; 98  $\mu\text{l}$  equilibration buffer, 1  $\mu\text{l}$  biotinylated nucleotide mix, 1  $\mu\text{l}$  TdT enzyme) at 37° C. for 1 hour. The reaction was terminated by adding 100  $\mu\text{l}$  2 $\times$ SCC (1:10; 2 $\times$ SCC:deionized water), endogenous peroxidases were blocked by incubating with  $\text{H}_2\text{O}_2$  (100  $\mu\text{l}$ ; 0.3% in PBS) for 5 min at room temperature, and washed cells were incubated for 30 min at room temperature in streptavidin HRP solution (100  $\mu\text{l}$ ; 1:500 in PBS) to allow binding to biotinylated nucleotides. Diaminobenzidine solution was added to washed cells, and the incubation proceeded for 10 min at room temperature. Cells were washed with deionised water, dehydrated through graded ethanol, and then cleared with xylene after which slides were mounted in DPX mounting medium and coverslipped. TUNEL positive cells were expressed as a percentage of the total.

#### [0099] Statistical Analysis

[0100] Data were analyzed, as appropriate, using either the Student's t-test for independent means, or by using a one-way analysis of variance (ANOVA) followed by post hoc analysis using the Student Newman Keuls test.

### RESULTS

#### [0101] A: Hippocampus

[0102] Mean body weight, dose of urethane administered to induce anaesthesia, and stimulus strength required to induce an epsp spike were calculated. There was no significant

difference between groups in body weight (FIG. 1A) or urethane concentration (FIG. 1B) administered due to immune modulation therapy.

[0103] FIG. 1 demonstrates that immune modulation therapy does not significantly alter body weight (a) or dose of urethane administered to induce anaesthesia (b). There is however an increase in the amplitude required to induce an action potential (c). The data are expressed as means with standard errors.

[0104] Tetanic stimulation delivered to the perforant path 3 h after intraperitoneal injection of LPS resulted in an increase in the mean slope of the population excitatory post-synaptic potential (epsp). The mean percentage change in the 2 min immediately following tetanic stimulation ( $\pm$ SEM; compared with the 5 min immediately before tetanic stimulation) was 114.49 ( $\pm$ 2.79), but this was not maintained so that the mean percentage change in population epsp slope in the last 5 min of the experiment was 90.32 ( $\pm$ 2.42). The corresponding values in the saline-treated control rats were 170.15 ( $\pm$ 10.16) and 121.28 ( $\pm$ 1.20), respectively (FIG. 2). The LPS induced inhibition of LTP was blocked by pre-treatment with immune modulation therapy.

[0105] FIG. 2 demonstrates that the LPS-induced impairment of LTP, was inhibited by pre-treatment with immune modulation therapy. The mean population epsp slope immediately after tetanic stimulation was attenuated in LPS-treated rats compared with saline-treated rats and was close to baseline at the end of the 40 min post-tetanus recording period. The inhibitory effect of LPS on LTP was blocked by pre-treatment with immune modulation therapy, which exerted no significant effect in saline-challenged rats. The data presented are means of seven to eight observations in each treatment group.

[0106] The mean percentage change in population epsp slope ( $\pm$ SEM) in the 2 min immediately after tetanic stimulation was 166.85 ( $\pm$ 4.54) in the sham pretreated, saline challenged group compared with 147.44 ( $\pm$ 5.84) in the group pretreated with immune modulation therapy and challenged with LPS. In the last 5 min of the experiment the values were 121.96 ( $\pm$ 0.85) and 128.07 ( $\pm$ 1.46), respectively (n=7-8).

[0107] Dissociated cells prepared from fresh hippocampal tissue displayed an increased number of apoptotic cells after LPS injection as evidenced by increased number of cells displaying dark brown stained nuclei i.e. TUNEL positive cells. This contrasts with cells prepared from hippocampus of saline-treated rats and rats treated with immune modulation therapy. Treatment with immune modulation therapy reversed the effects of LPS as shown by a reduction in the number of cells displaying TUNEL positive staining. The percentage of TUNEL positive cells was significantly increased in the LPS-treated group compared with the control treated group ( $p < 0.01$ ; ANOVA) and demonstrates that the immune modulation therapy reversed the degenerative effect of LPS ( $p < 0.01$ ; ANOVA).

[0108] B: Cortex

[0109] Animals were administered either immune modulation therapy or sham treatments, as previously described, and the following measurements were made in the cortex: ROS accumulation, TNF- $\alpha$  and IL-10 levels. These experiments were performed without LPS stimulation of the animals.

[0110] FIG. 3 indicates that immune modulation therapy significantly reduces reactive oxygen species accumulation in the cortex ( $p < 0.05$ ; student's t-test for independent means,  $n = 7-8$ ). The data are expressed as means with standard errors.

[0111] The concentration of pro-inflammatory cytokine, TNF $\alpha$  is significantly reduced in the cortex as a result of immune modulation therapy ( $p < 0.01$ ; student's t-test for independent means, FIG. 4a). In contrast, IL-10 concentration is significantly increased ( $p < 0.01$ ; student's t-test for independent means) (FIG. 4b). FIGS. 4a and 4b show that immune modulation therapy significantly reduces TNF $\alpha$  concentration (a) and significantly increases IL-10 concentration (b) in the cortex ( $p < 0.01$ ; student's t-test for independent means;  $n = 7-8$ ). The data are expressed as means with standard errors.

[0112] FIG. 5 illustrates that immune modulation therapy decreased JNK activity as indicated by a decrease in the phosphorylated form of JNK. Analysis of the mean data obtained from densitometric analysis indicated that Vaso-Care™ therapy significantly reduced kinase activity ( $p < 0.05$ ; student's t-test for independent means). FIG. 5 shows that immune modulation therapy significantly reduces JNK activity in the cortex ( $p < 0.05$ ; student's t-test for independent means;  $n = 7-8$ ). The data are expressed as means with standard errors.

[0113] With respect to the concentration of IL-1 Receptor Type I in cortical tissue, pilot work indicates that immune modulation therapy reduces IL-1 Receptor Type I expression (FIG. 6). The concentration of ligand pro-inflammatory IL-1 $\beta$  itself is expected to be lower, and is under examination. FIG. 6 shows that immune modulation therapy reduces the concentration of IL-1 Receptor Type I (preliminary data;  $n = 3$ ). The data are expressed as means with standard errors.

[0114] Analysis of endogenous glutamate release in synaptosomes prepared from tetanized and untetanized tissue obtained from these rats revealed a significant effect of LPS injection. Addition of 40 mM KCl to synaptosomes prepared from untetanized dentate gyrus obtained from saline-treated control rats, significantly increased glutamate release ( $p < 0.05$ ; Student t-test for paired means) albeit to an attenuated degree. This immune modulation therapy reversed the LPS-induced blockage of KCl stimulated glutamate release in untetanized dentate gyrus and to a more significant degree in tetanized tissue ( $p < 0.01$ ; Student t-test for paired means). This immune modulation therapy may exert its protective effect on synaptic function by acting to prevent this LPS-induced signaling event.

#### BIBLIOGRAPHY

[0115] Bliss T V, Collingridge G L. A synaptic model of memory: long-term potentiation in the hippocampus. *Nature*. 1993 361(6407):31-9.

[0116] Bradford M M. A rapid and sensitive method for the quantitation of microgram quantities of protein utilizing the principle of protein-dye binding. *Anal Biochem*. 1976 72:248-54.

[0117] Green L N. Corticosteroids in the treatment of Sydenham's chorea. *Arch. Neurol*. January 1978; 35(1): 53-4.

[0118] Haan E A, Bowen D M. Protection of neocortical tissue prisms from freeze-thaw injury by dimethyl sulphoxide. *J Neurochem*. 1981 37(1):243-6.

[0119] Kedziora J, Bartosz G. Down's syndrome: a pathology involving the lack of balance of reactive oxygen species. *Free Radic. Biol. Med.*, 1988; 4(5): 317-30.

[0120] Kouamé N, Carioto S, Hamet P, Tremblay J. Vasocare-therapy attenuates telemetered temperature response to stress in SHR. 9<sup>th</sup> International Symposium on SHR and Cardiovascular Genetics, Montreal, Canada, #P-136, Nov. 13-16, 1997.

[0121] Layton M E, Pazdernik T L. Reactive oxidant species in piriform cortex extracellular fluid during seizures induced by systemic kainic acid in rats. *J. Mol. Neurosci* August-October 1999, 13(1-2): 63-8.

[0122] LeBel C P, Ischiropoulos H, Bondy S C. Evaluation of the probe 2',7'-dichlorofluorescein as an indicator of reactive oxygen species formation and oxidative stress. *Chem Res Toxicol*. 1992 5(2):227-31.

[0123] Maroney A C, Glicksman M A, Basma A N, Walton K M, Knight E, Murphy C A, Bartlett B A, Finn J P, Angeles T, Matsuda Y, Neff N T, Dionne C A. Motoneuron apoptosis is blocked by CEP-1347 (KT 7515), a novel inhibitor of the JNK signaling pathway. *J Neurosci*. 1998 18(1):104-11.

[0124] Martin D S D, Towey M, Horrobin D F, Lynch M A. A diet enriched in  $\alpha$ -lipoic acid reverses the age-related compromise in antioxidant defenses in rat cortical tissue. *Nutritional Neuroscience* 2000 3: 193-206.

[0125] McGahon B, Lynch M A. The synergism between metabotropic glutamate receptor activation and arachidonic acid on glutamate release is occluded by induction of long-term potentiation in the dentate gyrus. *Neuroscience*. 1996 72(3):847-55.

[0126] Mogi M, Harada M, Narabayashi H, Inagaki H, Minami M, Nagatsu T. Interleukin (IL)-1 $\beta$ , IL-2, IL-4, IL-6 and transforming growth factor- $\alpha$  levels are elevated in ventricular cerebrospinal fluid in juvenile parkinsonism and Parkinson's disease. *Neurosci Lett*. 1996 211(1):13-6.

[0127] Murray C A, Lynch M A. Evidence that increased hippocampal expression of the cytokine interleukin-1 $\beta$  is a common trigger for age- and stress-induced impairments in long-term potentiation. *J Neurosci*. 1998 18(8):2974-81.

[0128] O'Donnell E, Vereker E, Lynch M A. Age-related impairment in LTP is accompanied by enhanced activity of stress-activated protein kinases: analysis of underlying mechanisms. *Eur J Neurosci*. 2000 12(1):345-52.

- [0129] Park D S, Stefanis L, Yan C Y, Farinelli S E, Greene L A. Ordering the cell death pathway. Differential effects of BCL2, an interleukin-1-converting enzyme family protease inhibitor, and other survival agents on JNK activation in serum/nerve growth factor-deprived PC12 cells. *J Biol Chem.* 1996 271(36):21898-905.
- [0130] Rabinovitch B A, Matukas L, Raju K, Punhani T, deVeber G, Keystone E. VasoCare™ PSCT normalizes the Th2 cell subset in scleroderma. XII Pan-American Congress of Rheumatology, Montreal, Canada, 1998.
- [0131] Schuchmann S, Heinemann U. Increased mitochondrial superoxide generation in neurons from trisomy 16 mice: a model of Down's syndrome. *Free Radic. Biol. Med Jan.* 15, 2000; 28(2): 235-50.
- [0132] Shivji G M, Suzuki H, Mandel A S, Bolton A E, Sauder D N. The effect of VAS972 on allergic contact hypersensitivity *J Cutan Med Surg.* 2000 4(3):132-7.
- [0133] Tennefi L, D'Emilia D M, Troy C M, Lipton S A. Role of caspases in N-methyl-D-aspartate-induced apoptosis in cerebrocortical neurons. *J Neurochem.* 1998 71(3):946-59.
- [0134] Trembovler V, Beit-Yannai E, Younis F, Gallily R, Horowitz M, Shohami E. Antioxidants attenuate acute toxicity of tumor necrosis factor-alpha induced by brain injury in rat. *J. Interferon Cytokine Res July* 1999; 19(7): 791-5.
- [0135] Vereker E, Campbell V, Roche E, McEntee E, Lynch M A. Lipopolysaccharide inhibits long term potentiation in the rat dentate gyrus by activating caspase-1. *J Biol Chem.* 2000a 275(34):26252-8.
- [0136] Vereker E, O'Donnell E, Lynch M A. The inhibitory effect of interleukin-1b on long-term potentiation is coupled with increased activity of stress-activated protein kinases. *J Neurosci.* 2000b 20(18):6811-9.
- [0137] Wildburger R, Borovic S, Zarkovic N, and Tatzber F. Post-traumatic dynamic changes in the antibody titer against oxidized low density lipoproteins. *Wien Klin Wochenshr Sep.* 29, 2000; 112(18) 798-803.
4. The method of claim 2, wherein the oxidizing agent comprises a mixture of ozone gas and medical grade oxygen, the ozone gas being contained in the mixture in a concentration of up to about 300  $\mu\text{g/ml}$ .
5. The method of claim 4, wherein the ozone gas is contained in the mixture in a concentration of up to about 30  $\mu\text{g/ml}$ .
6. The method of claim 5, wherein the ozone gas is contained in the mixture in a concentration of from about 13.5  $\mu\text{g/ml}$  to about 15.5  $\mu\text{g/ml}$ .
7. The method of claim 4, wherein the mixture is applied to the aliquot at a flow rate of up to about 0.33 liters/min.
8. The method of claim 7, wherein the mixture is applied to the aliquot at a flow rate of from about 0.21 liters/min to about 0.27 liters/min.
9. The method of claim 1, wherein the electromagnetic radiation comprises ultraviolet light having one or more UV-C band wavelengths.
10. The method of claim 1, wherein the temperature to which the aliquot is cooled or heated is a temperature which does not result in substantial hemolysis of the blood in the aliquot.
11. The method of claim 1, wherein the temperature stressor is applied so that the temperature of at least part of the aliquot is in the range of from about  $-5^{\circ}\text{C}$ . to about  $55^{\circ}\text{C}$ .
12. The method of claim 1, wherein the mean temperature of the blood in the aliquot is in the range of from about  $37^{\circ}\text{C}$ . to about  $44^{\circ}\text{C}$ .
13. The method of claim 1, wherein the mean temperature of the blood in the aliquot is in the range of from about  $0^{\circ}\text{C}$ . to about  $36.5^{\circ}\text{C}$ .
14. The method of claim 1, wherein the mean temperature of the blood in the aliquot is in the range of from about  $10^{\circ}\text{C}$ . to about  $30^{\circ}\text{C}$ .
15. The method of claim 1, wherein the temperature is in the range of from about  $37^{\circ}\text{C}$ . to about  $55^{\circ}\text{C}$ .
16. The method of claim 15, wherein the temperature is  $42.5\pm 1^{\circ}\text{C}$ .
17. The method of claim 1, wherein the volume of the aliquot is up to about 400 ml.
18. The method of claim 17, wherein the volume of the aliquot is about 10 ml.
19. The method of claim 17, wherein the volume of the aliquot is about 2 ml.
20. The method of claim 1, wherein the aliquot is subjected to the stressors for a period of up to about 60 minutes.
21. The method of claim 20, wherein the aliquot is subjected to the stressors for a period of about 3 minutes.
22. The method of claim 1, wherein the blood is administered to the mammal by a method suitable for vaccination selected from the group consisting of intra-arterial injection, intramuscular injection, intravenous injection, subcutaneous injection, intraperitoneal injection, and oral, nasal or rectal administration.
23. The method of claim 1, wherein all of the stressors are simultaneously administered to the aliquot.
24. The method of claim 1, wherein any two of the stressors are simultaneously administered to the aliquot.
25. The method of claim 24 wherein the mammal is a human.
26. The method of claim 24 wherein the neurological disease is selected from the group consisting of Down's syndrome, Huntington's disease, brain trauma and epilepsy,

What is claimed is:

1. A method for the prophylactic or therapeutic treatment of inflammatory components and inflammatory aspects of a neurological disease in a mammalian patient, which method comprises:

administering to said patient an aliquot of blood which has been treated ex vivo with at least two stressors selected from the group consisting of an oxidative environment, thermal stress and electromagnetic radiation;

wherein the concentration of the reactive oxygen species in neuronal cells or tissues of said patient is reduced, with associated reduction of harmful inflammatory effects therein.

2. The method of claim 1, wherein the oxidative environment comprises applying an oxidizing agent to the aliquot.

3. The method of claim 2, wherein the oxidizing agent contains ozone gas, and the ozone gas is introduced into the blood aliquot in an amount which does not give rise to excessive levels of cell damage.

4. The method of claim 2, wherein the oxidizing agent comprises a mixture of ozone gas and medical grade oxygen, the ozone gas being contained in the mixture in a concentration of up to about 300  $\mu\text{g/ml}$ .

5. The method of claim 4, wherein the ozone gas is contained in the mixture in a concentration of up to about 30  $\mu\text{g/ml}$ .

6. The method of claim 5, wherein the ozone gas is contained in the mixture in a concentration of from about 13.5  $\mu\text{g/ml}$  to about 15.5  $\mu\text{g/ml}$ .

7. The method of claim 4, wherein the mixture is applied to the aliquot at a flow rate of up to about 0.33 liters/min.

8. The method of claim 7, wherein the mixture is applied to the aliquot at a flow rate of from about 0.21 liters/min to about 0.27 liters/min.

9. The method of claim 1, wherein the electromagnetic radiation comprises ultraviolet light having one or more UV-C band wavelengths.

10. The method of claim 1, wherein the temperature to which the aliquot is cooled or heated is a temperature which does not result in substantial hemolysis of the blood in the aliquot.

11. The method of claim 1, wherein the temperature stressor is applied so that the temperature of at least part of the aliquot is in the range of from about  $-5^{\circ}\text{C}$ . to about  $55^{\circ}\text{C}$ .

12. The method of claim 1, wherein the mean temperature of the blood in the aliquot is in the range of from about  $37^{\circ}\text{C}$ . to about  $44^{\circ}\text{C}$ .

13. The method of claim 1, wherein the mean temperature of the blood in the aliquot is in the range of from about  $0^{\circ}\text{C}$ . to about  $36.5^{\circ}\text{C}$ .

14. The method of claim 1, wherein the mean temperature of the blood in the aliquot is in the range of from about  $10^{\circ}\text{C}$ . to about  $30^{\circ}\text{C}$ .

15. The method of claim 1, wherein the temperature is in the range of from about  $37^{\circ}\text{C}$ . to about  $55^{\circ}\text{C}$ .

16. The method of claim 15, wherein the temperature is  $42.5\pm 1^{\circ}\text{C}$ .

17. The method of claim 1, wherein the volume of the aliquot is up to about 400 ml.

18. The method of claim 17, wherein the volume of the aliquot is about 10 ml.

19. The method of claim 17, wherein the volume of the aliquot is about 2 ml.

20. The method of claim 1, wherein the aliquot is subjected to the stressors for a period of up to about 60 minutes.

21. The method of claim 20, wherein the aliquot is subjected to the stressors for a period of about 3 minutes.

22. The method of claim 1, wherein the blood is administered to the mammal by a method suitable for vaccination selected from the group consisting of intra-arterial injection, intramuscular injection, intravenous injection, subcutaneous injection, intraperitoneal injection, and oral, nasal or rectal administration.

23. The method of claim 1, wherein all of the stressors are simultaneously administered to the aliquot.

24. The method of claim 1, wherein any two of the stressors are simultaneously administered to the aliquot.

25. The method of claim 24 wherein the mammal is a human.

26. The method of claim 24 wherein the neurological disease is selected from the group consisting of Down's syndrome, Huntington's disease, brain trauma and epilepsy,

chronic inflammatory demyelinating polyneuropathy, Guillain-Barré syndrome, myasthenia gravis, dermatomyositis, polymyositis, inclusion body myositis, post stroke, neuro-sarcoidosis, vascular dementia, closed head trauma, vasospasm, subarachnoid hemorrhage, adrenal leukocytic dystrophy, inclusion body dermatomyositis, minimal cognitive impairment and duchenne muscular dystrophy

27. The method of claim 1 including the additional steps of

- (a) identifying a patient having a neurological disease condition, or is at risk of having a neurological disease condition, which has a significant inflammatory component;
- (b) evaluating the patient identified in (a) above to determine whether that disease condition or risk of disease condition can be effectively treated by reducing the concentration of reactive oxygen species; and
- (c) if a reduction in the concentration of reactive oxygen species would be suitable for the prophylactic or thera-

peutic treatment of such a disease, then administering to said patient an aliquot of blood which has been treated ex vivo with at least one stressor selected from the group consisting of an oxidative environment, thermal stress and UV light.

28. A process for alleviating the symptoms of a neurological brain disorder having a significant inflammatory component associated with excess active oxygen species (reactive oxygen species and oxidative free radicals), such as Down's syndrome, Huntington's disease, epilepsy and brain traumas, which comprises scavenging of active oxygen species from the brain of a mammalian patient by administering to said patient an aliquot of blood which has been treated ex vivo with at least one stressor selected from the group consisting of an oxidative environment, thermal stress and UV light.

\* \* \* \* \*





US007122208B2

(12) **United States Patent**  
**Bolton et al.**

(10) **Patent No.:** **US 7,122,208 B2**  
(45) **Date of Patent:** **Oct. 17, 2006**

(54) **COMPOSITIONS CONTAINING APOPTOTIC ENTITIES**

(75) Inventors: **Anthony E. Bolton**, Tideswell (GB);  
**Arkady Mandel**, North York (CA)

(73) Assignee: **Vasogen Ireland Limited**, (IE)

(\* ) Notice: Subject to any disclaimer, the term of this patent is extended or adjusted under 35 U.S.C. 154(b) by 453 days.

(21) Appl. No.: **10/115,943**

(22) Filed: **Apr. 5, 2002**

(65) **Prior Publication Data**

US 2002/0155098 A1 Oct. 24, 2002

**Related U.S. Application Data**

(60) Provisional application No. 60/282,120, filed on Apr. 6, 2001.

(51) **Int. Cl.**  
**A61K 35/14** (2006.01)

(52) **U.S. Cl.** ..... **424/529; 424/93.7; 435/2; 435/366; 435/372**

(58) **Field of Classification Search** ..... **424/529, 424/93.7; 435/2, 366, 372**

See application file for complete search history.

(56) **References Cited**

**U.S. PATENT DOCUMENTS**

5,834,030 A 11/1998 Bolton  
5,980,954 A \* 11/1999 Bolton ..... 424/613  
6,086,552 A 7/2000 Bolton

**FOREIGN PATENT DOCUMENTS**

WO 96/34613 11/1996  
WO 00/41705 7/2000

**OTHER PUBLICATIONS**

Kuljis et al., Minimal Cognitive Impairment, <http://www.emedicine.com/neuro/topic714.htm>, last updated Jun. 18, 2004.\*  
Mecocci, Journal of Alzheimer's Disease 6: 159-163 (2004).\*  
Malfroy et al., Cellular Immunology 177: 62-68 (1997).\*  
Bliss TV, Collingridge GL. "A synaptic model of memory: long-term potentiation in the hippocampus." *Nature*. 361(6407):31-9 (1993).  
Bradford MM. "A rapid and sensitive method for the quantitation of microgram quantities of protein utilizing the principle of protein-dye binding." *Anal Biochem*. 72:248-54 (1976).  
Green LN. "Corticosteroids in the treatment of Sydenham's chorea." *Arch. Neurol.* 35(1): 53-4 (1978).  
Haan EA, et al. "Protection of neocortical tissue prisms from freeze-thaw injury by dimethyl sulphoxide." *J. Neurochem.* 37(1):243-6 (1981).  
Kedziora J, et al. "Down's syndrome: a pathology involving the lack of balance of reactive oxygen species." *Free Radic. Biol. Med.* 4(5): 317-30 (1988).  
Kouamé N, et al. "Vasocare-therapy attenuates telemetered temperature responses to stress in SHR." 9<sup>th</sup> International Symposium on SHR and Cardiovascular Genetics, Montreal, Canada, #P-136, Nov. 13-16, 1997. (abstract).

Layton ME, et al. "Reactive oxidant species in piriform cortex extracellular fluid during seizures induced by systemic kainic acid in rats." *J. Mol. Neurosci* 13(1-2): 63-8 (1999).

Lebel CP, et al. "Evaluation of the probe 2',7'-dichlorofluorescein as an indicator of reactive oxygen species formation and oxidative stress." *Chem Res Toxicol*. 5(2):227-31 (1992).

Maroney AC, et al. "Motoneuron apoptosis is blocked by CEP-1347 (KT 7515), a novel inhibitor of the JNK signaling pathway." *J Neurosci*. 18(1):104-11 (1998).

Martin DSD, et al. "A diet enriched in  $\alpha$ -lipoic acid reverses the age-related compromise in antioxidant defenses in rat cortical tissue." *Nutritional Neuroscience* 3: 193-206 (2000).

Megahon B, et al. "The synergism between metabotropic glutamate receptor activation and arachidonic acid on glutamate release is occluded by induction of long-term potentiation in the dentate gyrus." *Neuroscience*. 72(3):847-55 (1996).

Mogi M, et al. "Interleukin (IL)-1 $\beta$ , IL-2, IL-4, IL-6 and transforming growth factor- $\alpha$  levels are elevated in ventricular cerebrospinal fluid in juvenile parkinsonism and Parkinson's disease." *Neurosci Lett*. 211(1):13-6 (1996).

Murray CA, et al. "Evidence that increased hippocampal expression of the cytokine interleukin-1 $\beta$  is a common trigger for age- and stress-induced impairments in long-term potentiation." *J Neurosci*. 18(8):2974-81 (1998).

O'Donnell E, et al. "Age-related impairment in LTP is accompanied by enhanced activity of stress-activated protein kinases: analysis of underlying mechanisms." *Eur J Neurosci*. 12(1):345-52 (2000).

Park DS, et al. "Ordering the cell death pathway. Differential effects of BCL2, an interleukin-1-converting enzyme family protease inhibitor, and other survival agents on JNK activation in serum/nerve growth factor-deprived PC12 cells." *J Biol Chem*. 271(36):21898-905 (1996).

Rabinovitch BA, et al. "VasoCare™ PSCT normalizes the Th2 cell subset in scleroderma." XII Pan-American Congress of Rheumatology, Montreal, Canada, 1998.

Schuchmann S, et al. "Increased mitochondrial superoxide generation in neurons from trisomy 16 mice: a model of Down's syndrome." *Free Radic. Biol. Med.* 28(2): 235-50 (2000).

Shivji GM, et al. "The effect of VAS972 on allergic contact hypersensitivity." *J Cutan Med Surg*. 4(3):132-7 (2000).

Tenneti L, et al. "Role of caspases in N-methyl-D-aspartate-induced apoptosis in cerebrocortical neurons." *J Neurochem*. 71(3):946-59 (1998).

Trembovler V, et al. "Antioxidants attenuate acute toxicity of tumor necrosis factor- $\alpha$  induced by brain injury in rat." *J. Interferon Cytokine Res*. 19(7): 791-5 (1999).

Vereker E, et al. "Lipopolysaccharide inhibits long term potentiation in the rat dentate gyrus by activating caspase-1." *J Biol Chem*. 275(34):26252-8 (2000).

(Continued)

Primary Examiner—Jean C. Witz  
(74) Attorney, Agent, or Firm—Foley & Lardner LLP

(57) **ABSTRACT**

Disclosed are methods for treating and preventing neurological disorders which have a significant inflammatory component. The methods of the present invention involve extracting blood from a patient, subjecting the blood ex vivo to at least one stressor selected from the group consisting of an oxidative environment, thermal stress and UV light, and then re-administering the blood to the patient, thereby reducing inflammation.

**28 Claims, 4 Drawing Sheets**

OTHER PUBLICATIONS

Vereker E, et al. "The inhibitory effect of interleukin-1b on long-term potentiation is coupled with increased activity of stress-activated protein kinases." *J Neurosci.* 20(18):6811-9 (2000).

Wildburger R, et al. "Post-traumatic dynamic changes in the antibody titer against oxidized low density lipoproteins." *Wien Klin Wochenshr.* 112(18) 798-803 (2000).

Database Medline [Online] US National Library of Medicine (NLM), Bethesda, MD, US; 1998, Sagara Y: "Cellular mechanisms of resistance to oxidative stress," Database accession No. NLM964I255.

Database Medline [Online] US National Library of Medicine (NLM), Bethesda, MD, US; 1995, Rogers J: "Inflammation as a

pathogenic mechanism in Alzheimer's disease," Database accession No. NLM7763341.

Database Medline [Online] US National Library of Medicine (NLM), Bethesda, MD, US; 1999, Hirsch E C: "Mechanism and consequences of nerve cell death in Parkinson's disease," Database accession No. NLM10370907.

Database Medline [Online] US National Library of Medicine (NLM), Bethesda, MD, US; 2003, Beal M F: "Mitochondria, oxidative damage and inflammation in Parkinson's disease," Database accession No. NLM1284698I.

\* cited by examiner

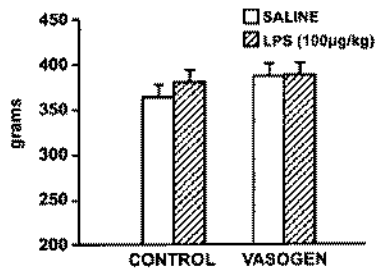


FIG. 1a

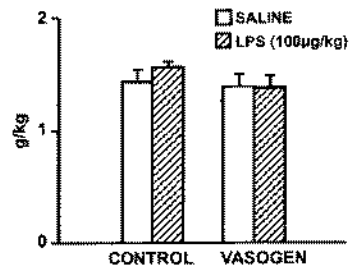


FIG. 1b

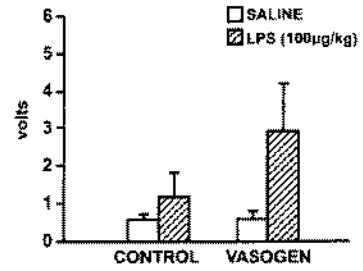


FIG. 1c

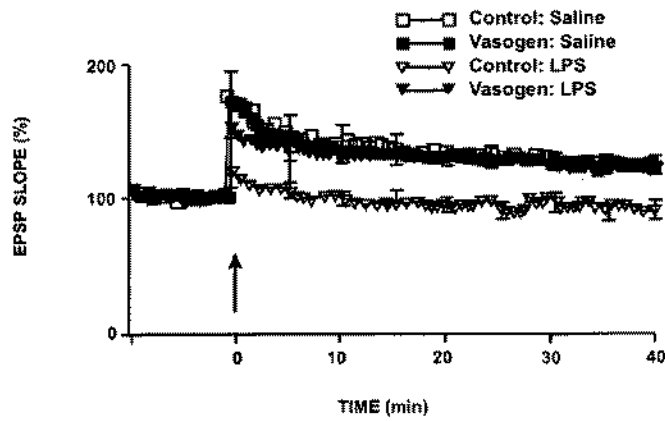


FIG. 1d

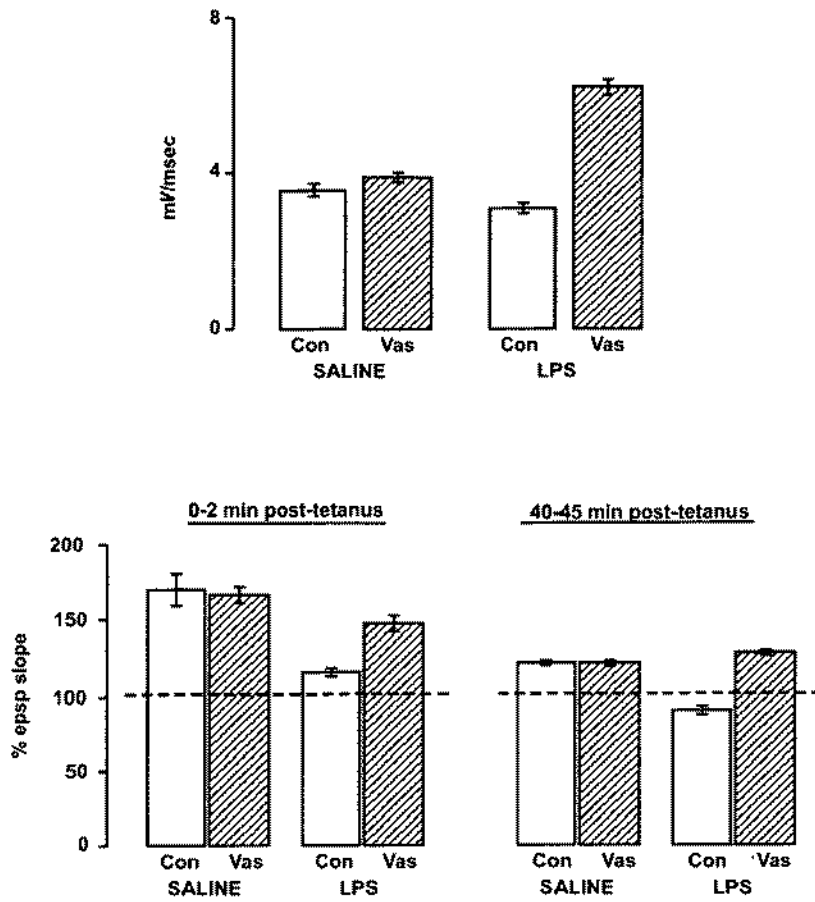


FIG. 2

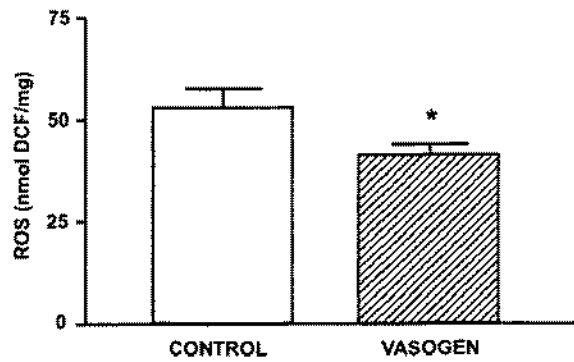


FIG. 3

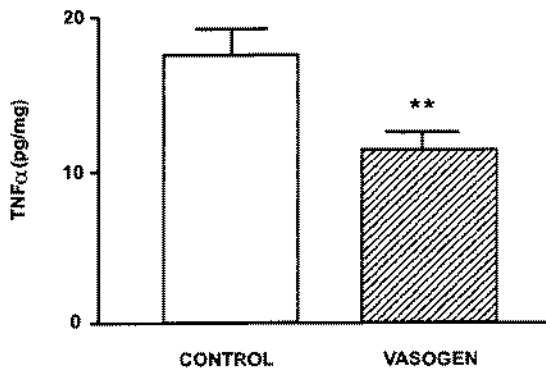


FIG. 4a

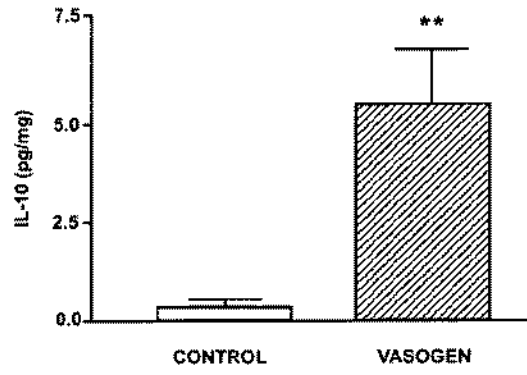


FIG. 4b

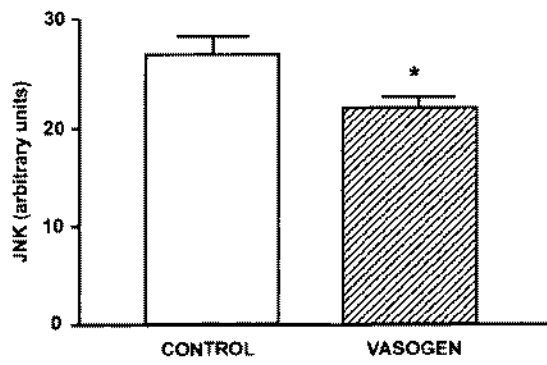


FIG. 5

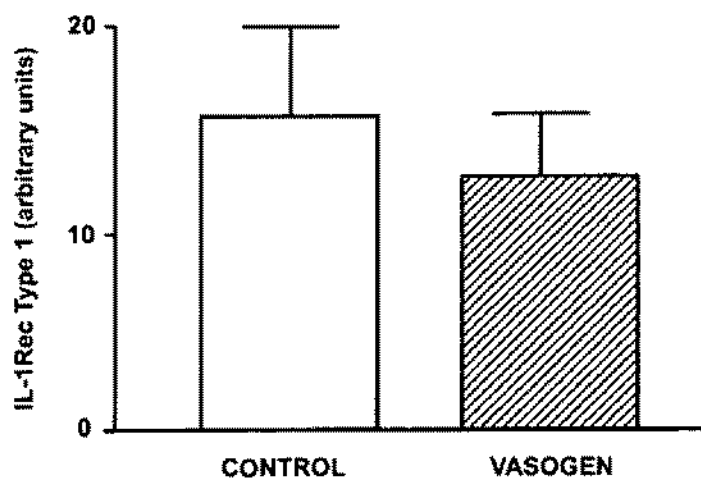


FIG. 6

## COMPOSITIONS CONTAINING APOPTOTIC ENTITIES

### REFERENCE TO RELATED APPLICATIONS

This application is based upon and claims priority from U.S. provisional patent application serial No. 60/282,120 filed Apr. 6, 2001, the disclosure of which is incorporated herein by reference, in its entirety.

### BACKGROUND OF THE INVENTION

#### 1. Field of the Invention

This invention is directed to methods for treating the inflammatory component of brain disorders in mammalian patients, and more particularly for treating those neurological brain disorders in which reactive oxygen species play a significant role in the underlying inflammatory pathology.

#### 2.State of the Art

The events that lead to neurological disorders with a significant inflammatory component (including myasthenia gravis, GBS, CIDP, and multiple sclerosis) are not clear, but the following sequential steps appear to be critical. (1) The breaking of tolerance, a process in which cytokines, molecular mimicry, or superantigens may play a role in rendering previously anergic T-cells to recognize neural autoantigens. (2) Antigen recognition by the T-cell receptor complex and processing of the antigen via the major histocompatibility complex class I or II. (3) Costimulatory factors, especially B7 and B7-binding proteins (CD28, CTLA-4) and intercellular adhesion molecule (ICAM-1) and its leukocyte function-associated (LFA)-1 ligand. (4) Traffic of the activated T cells across the blood-brain or blood-nerve barrier via a series of adhesion molecules that include selectins, leukocyte integrins (LFA-1, Mac-1, very late activating antigen (VLA)-4) and their counterreceptors (ICAM-1, vascular cell adhesion molecule (VCAM)) on the endothelial cells. (5) Tissue injury when the activated T cells, macrophages, or specific autoantibodies find their antigenic targets on glial cells, myelin, axon, calcium channels, or muscle.

In designing specific immunotherapy, the main components involved in every step of the immune response need to be considered. Targets for specific therapy in neurological disease include agents and treatments that (a) interfere or compete with antigen recognition or stimulation; (b) inhibit costimulatory signals or cytokines; (c) inhibit the traffic of the activated cells to tissues; and (d) intervene at the antigen recognition sites in the targeted organ.

Reactive oxygen species (ROS) are activated forms of oxygen, including superoxide anion ( $O_2^{\cdot-}$ ) and hydroxyl radicals ( $HO\cdot$ ) together with hydrogen peroxide ( $H_2O_2$ ) and various unstable intermediates of lipid peroxidation. They are generated as a result of aerobic metabolism. Neuronal brain tissue is particularly susceptible to oxidative damage due its to high consumption of oxygen and its limited antioxidant defense system. Reactive oxygen species formation is thought to have an impact on synaptic plasticity, cell signaling and the aging process. An age-related increase in reactive oxygen species production has been demonstrated (Martín et al., 2000) and the accumulation of reactive oxygen species has also been shown to be increased in the hippocampus as a consequence of peripheral LPS administration (Vereker et al., 2000a). This is mimicked by IL-1 $\beta$  administration (Vereker et al., 2000b). O'Donnell and colleagues (2000) have reported parallel changes in reactive oxygen species formation and IL-1 $\beta$  production; reactive oxygen species formation was shown to cause an increase in

IL-1 $\beta$  production while IL-1 $\beta$  has the ability to induce reactive oxygen species formation thus suggesting the existence of a positive feedback loop which is potentially damaging to cells.

Increased concentrations of IL-1 $\beta$  have also been closely linked with neuronal degeneration (Mogi et al., 1996; Teneti et al., 1998).

Enhanced activity of the stress-activated kinase c-Jun NH<sub>2</sub>-terminal kinase (JNK) is associated with cell degeneration and death (Park et al., 1996; Maroney et al., 1998), and has been shown to be activated in the hippocampus by several agents, including hydrogen peroxide, an inducer of reactive oxygen species production, and pro-inflammatory cytokines.

Another example of a neuronal brain deficit induced by IL-1 $\beta$  and LPS, is the impairment of long term potentiation (LTP) in the hippocampus (Vereker et al 2000a; Murray & Lynch, 1998). LTP is a form of synaptic plasticity that was originally described in the hippocampus, a brain region that is particularly vulnerable to degeneration which is associated with cognitive dysfunction. On the basis of this and other observations, LTP has been proposed as a biological substrate for learning and memory (Bliss & Collingridge, 1993).

Certain neurological brain disorders such as Downs syndrome (Layton et al., Kedziora et al., Schuchmann et. al.), epilepsy, brain trauma (e.g. physical damage to the brain such as concussion)(Layton et. al., Wildburgir et. al., Trembovler et. al.) and Huntington's disease (chorea)(Green) are currently understood to involve inflammation of brain cells as a significant component of the underlying pathology of the disorder. This inflammation could be the consequence of one or more of a variety of biological processes, such as the generation of excess-amounts of inflammatory cytokines such as IL-1 $\beta$  and TNF- $\alpha$ , in the brain cells or other components of the brain tissue, perhaps associated with the presence of high concentrations of reactive oxygen species in the brain tissue, which correlates to high levels of tissue damage or exacerbation of the disease. Reactive oxygen species are one of the effectors of inflammation in tissue such as brain tissue.

Other neurological disorders which have a significant inflammatory component include Guillain-Barré syndrome (GBS), chronic inflammatory demyelinating polyneuropathy (CIDP), myasthenia gravis (MG), dermatomyositis, polymyositis, inclusion body myositis, post stroke, neurosarcoidosis, vascular dementia, closed head trauma, vasospasm, subarachnoid hemorrhage, adrenal leukocytic dystrophy (storage disorders), inclusion body dermatomyositis, minimal cognitive impairment and duchenne muscular dystrophy.

Chronic inflammatory demyelinating polyneuropathy (CIDP) is a neurological disorder characterized by slowly progressive weakness and sensory dysfunction of the legs and arms. The disorder, which is sometimes called chronic relapsing polyneuropathy, is caused by damage to the myelin sheath of the peripheral nerves. CIDP can occur at any age and in both genders, is more common in young adults, and in men more so than women. The primary symptoms include slowly progressive muscle weakness and sensory dysfunction affecting the upper and lower extremities. Other symptoms may include fatigue; abnormal sensations including burning, numbness and/or tingling sensations (beginning in the toes and fingers); paralysis of the arms and/or legs; weakened or absent deep tendon reflexes (areflexia); and, aching pain affecting various muscle groups.

CIDP is closely related to the more common, acute demyelinating neuropathy known as Guillain-Barré syndrome (GBS). CIDP is considered the chronic counterpart of the acute disease GBS. CIDP is distinguished from GBS, chiefly by clinical course and prognosis. However, both disorders have similar clinical features, and both share the CSF albuminocytological dissociation and the pathological abnormalities of multi-focal inflammatory segmental demyelination with associated nerve conduction features reflecting demyelination.

Guilain-Barré Syndrome (GBS) is an acute predominately motor polyneuropathy with spontaneous recovery that may lead to severe quadriplegia and requires artificial ventilation in 20–30% of patients. The diseases that underlie this syndrome have been classified as acute inflammatory demyelinating polyneuropathy (AIDP), the most common form, acute motor and sensory axonal neuropathy (AMSAN), and acute motor axonal neuropathy (AMAN). Fisher syndrome is a cranial nerve variant of GBS which characteristically results in ophthalmoplegia, ataxia and areflexia. GBS is often preceded by infection with either *Campylobacter jejuni*, which is most common, cytomegalovirus (CMV), Epstein-Barr virus or *Mycoplasma pneumoniae*.

Autoimmune myasthenia gravis (MG) is a disorder of neuromuscular transmission leading to fluctuating weakness and abnormal fatigability. Weakness is attributed to the blockade of acetylcholine receptors (AChRs) at the neuromuscular endplate by circulating autoantibodies, followed by local complement activation and destruction of acetylcholine receptors (Stangel et al, *J. Neurol. Sci.* 153(2): 203–14 (1998)). AChR is expressed on regenerating myoblasts but in normal adult muscle the AChR is only expressed at the motor endplate. In patients with early onset MG however the thymic medulla is infiltrated by lymph node-like T cells and germinal centres and there are myoblast-like myoid cells in the thymic medulla which express AChR. Therefore the presentation of the AChR antigen by these cells or by myoblasts is likely to be involved in the disease process (Curnow et al, *J. Neuroimmunol.* 115(1–2): 127–134 (2001)). In studies of experimental autoimmune myasthenia gravis (EAMG) the Th1 cytokine,  $INF-\gamma$ , has been shown to be involved in disease progression and has been reported to be capable of inducing the production by myoblasts of class I and II major histocompatibility antigens, AChR and ICAM-1. IL-1 has also been shown to play a role in EAMG where disruption of the IL-1 beta gene was shown to diminish acetylcholine receptor-induced responses (Garcia et al, *J. Neuroimmunol.* 120(1–2):103–11 (2001); Siegall et al, *J. Neuroimmunol.* 119(2):377–386 (2001)).

The causes of inflammatory muscle diseases dermatomyositis, polymyositis and inclusion body myositis (IBM) are unknown, but immune mechanisms are strongly implicated. Although clinically and immunopathologically distinct, these diseases share three dominant histological features: inflammation, fibrosis and loss of muscle fibres. In dermatomyositis, the endomysial inflammation and muscle fiber destruction is preceded by activation of the complement system of plasma proteins, and deposition of membranolytic attack complex on the endomysial capillaries (Dalakas, *Curr. Opin. Pharmacol.* 1(3):300–306 (2001)). There is evidence that this attack may also involve the blood vessels in the dermis (Dalakas et al, *Curr. Opin. Pharmacol.* 9(3): 235–239 (1996)). Transforming growth factor beta, shown to be overexpressed in the perimysial connective tissue in dermatomyositis, is down-regulated after successful immunotherapy and reduction of inflammation and fibrosis (Dalakas, *Arch. Neurol.* 55(12):1509–1512 (1998)).

In polymyositis and IBM the disease begins with the activation of CD8<sup>+</sup> T cells. These cytotoxic T cells reach the endomysial parenchyma to recognise muscle antigen(s) associated with the upregulation of the major histocompatibility complex (MHC) I on muscle fibres. The autoinvasive T cells exhibit gene rearrangement of their T-cell receptors (TCR) and are specifically selected and clonally expanded in situ by heretofore previously unknown antigens. Muscle cells do not normally express MHC I and II but in cases of polymyositis and IBM over expression of MHC is an early event that can be detected even in areas remote from the inflammation.  $INF-\gamma$  and  $TNF-\alpha$ , cytokines that induce MHC, have been found in patients with active polymyositis (Dalakas, *Curr. Opin. Pharmacol.* 1(3):300–306 (2001)).

No signs of apoptosis have been detected in patients with inflammatory myopathies and in fact two strong anti-apoptotic molecules have recently been found to be expressed in the muscle fibers. One is the Fas-associated death domain-like IL-1-converting enzyme inhibitory protein (FLIP) and the other human IAP (inhibitor of apoptosis protein)-like protein. The result of unsuccessful apoptotic clearance of inflammatory cells is likely to be the cause of the sustained chronic cytotoxic muscle fiber damage (Vattemi et al, *J. Neuroimmunol.* 111(1–2):146–151 (2000)).

Sarcoidosis is a multisystem chronic disorder with unknown cause and a worldwide distribution. Neurosarcoidosis is a complication of sarcoidosis involving inflammation and abnormal deposits in the tissues of the nervous system. Sudden, transient facial palsy is common with involvement of cranial nerve VII. Other manifestations include aseptic meningitis, hydrocephalus, parenchymatous disease of the central nervous system, peripheral neuropathy and myopathy. Intracranial sarcoid may mimic various forms of meningitis, including carcinomatous and intracranial mass lesions such as meningioma, lymphoma and glioma, based on neuroradiological imaging. A lumbar puncture may show signs of inflammation. Elevated levels of angiotensin converting enzyme may be found in the blood or CSF. Therapy consists of immunosuppressive agents and corticosteroids (Nowak et al, *J. Neurol.* 248(5):363–372 (2001); Stern et al, *Arch. Neurol.* 42(9):909–917 (1985)).

Vascular dementia (VaD) is the general term for dementia caused by organic lesions of vascular origin, such as cerebral infarction, intracerebral haemorrhage or ischemic changes in subcortical white matter. It is the most frequent cause of dementia after AD accounting for about 20% of cases and 50% in subjects over 80 years (Dib, *Arch. Gerontol. Geriatr.* 33(1):71–80 (2001); Parnetti et al, *Int. J. Clin. Lab Res.* 24(1):15–22 (1994)). The clinical distinction between AD and VaD may be difficult and there are standard guidelines for research studies. VaD and AD can co-exist as “mixed dementia” where the presence of cerebrovascular disease may worsen Alzheimer dementia. Traditionally AD is characterized by the insidious onset of memory loss, followed by a gradual progression to dementia in the face of normal findings on neurological examination. VaD on the other hand, is characterized by stepwise cognitive decline punctuated by episodes of stroke that are accompanied by focal deficits on neurological examination, and evidence of stroke on computed topography (CT) or magnetic-resonance imaging (Jagust, *Lancet* 358(9299):2097–2098 (2001)). It is assumed that the risk factors for stroke and vascular disease are also factors for VaD. These include hypertension, smoking, diabetes, obesity, cardiac rhythm disorders, hyperlipidaemia, hypercholesterolaemia and hyperhomocysteinaemia. The apolipoprotein E4 genotype is also considered as a risk factor for VaD, AD and ischemic stroke (Dib, *Arch.*



*Gerontol. Geriatr.* 33(1):71–80 (2001)). Current treatments of vascular dementia include anti-platelet agents and/or surgery, and the treatment of cognitive symptoms (Parnetti et al, *Int. J. Clin. Lab. Revs.* 24(1):15–22 (1994)).

Head trauma is associated with a variety of physiological and cellular phenomena such as ischemia, increased permeability of the blood-brain barrier (BBB), edema, necrosis and motor and memory dysfunction (Moor et al, *Neurosci. Lett.* 316(3):169–172 (2001); Shohami et al, *J. Neuroimmunol.* 72(2):169–177 (1997)). Ischemia caused by the initial brain injury induces a cascade of secondary events and the release of excitatory amino acids (EAA) such as glutamate and aspartate. Alteration in the levels of ions and neuro-modulators lead to oxidation and cellular membrane damage and ultimately cellular death (Stahel et al, *Brain Res. Rev.* 27(3):243–256 (1998)). Experimental models for closed head injury (CHI) developed in the rat show the spatial and temporal induction of IL-1, IL-6 and TNF- $\alpha$  gene mRNA transcription along with an induction of IL-6 and TNF- $\alpha$  activity in the rat brain (Shohami et al, *J. Neuroimmunol.* 72(2):169–177 (1997)). IL-1 $\beta$  has also been shown to be released and it is the presence of these cytokines along with damage to endothelial cells that result in disruption of the BBB integrity. This disruption allows the recruitment of neutrophils into the subarachnoid space (Stahel et al (1998)).

TNF- $\alpha$  has been identified in the brain in several pathological conditions and inhibitors of TNF- $\alpha$  such as dexamethasone (DEX) (HU-211) have been shown to improve neurological outcome following CHI (Shohami et al, *J. Neuroimmunol.* 72(2):169–177 (1997)).

Cerebral vasospasm is delayed onset cerebral artery narrowing in response to blood clots left in the subarachnoid space after spontaneous aneurysmal subarachnoid hemorrhage (SAH) (Ogihara et al, *Brain Res.* 889(1–2):89–97 (2001)). It is angiographically characterized as the persistent luminal narrowing of the major extraparenchymal cerebral arteries and affects the cerebral microcirculation and causes decreased cerebral blood flow (CBF) and delayed ischemic neurological deficits. A number of studies have demonstrated morphological changes in cerebral arteries after SAH. Smooth muscle cells showed necrotic changes, such as dense bodies, degeneration of mitochondria, condensed lysosomes and dissolution of nuclear substances and the appearance of cell debris (Sobey et al, *Clin. Exp. Pharmacol. Physiol.* 25(11):867–876 (1998)). The impaired dilator and increased constrictor mechanisms that occur after SAH may be caused by oxyhaemoglobin produced by erythrocytes that inactivates NO in the subarachnoid space. Alternatively it may be due to an impaired activity of soluble guanylate cyclase resulting in reduced basal levels of cGMP in cerebral vessels and so a reduced responsiveness to NO (Ogihara et al, *Brain Res.* 889(1–2):89–97 (2001)). Production of IL-6 and IL-8 in the cerebrospinal fluid following SAH has also been demonstrated. It is thought that IL-6 may play a particular role in vasospasm as in induced vasoconstriction in a canine cerebral artery (Osuka et al, *Acta Neurochir.* 140(9):943–951 (1998)).

Duchenne muscular dystrophy (DMD) is one of the most common, inherited, lethal disorders in childhood. It is an X-linked neuromuscular disease that affects 1 in 3500 males. Progressive muscle weakness begins between 2 and 5 years of age and ultimately leads to premature death by respiratory or cardiac failure during the middle to late twenties. Approximately 30% of cases are due to spontaneous mutation of the dystrophin genes while the remainder are inherited (Spencer et al, *Neuromuscul. Disord.* 11(6–7):556–564 (2001)). DMD patients therefore lack the protein dystrophin

which is an essential link in the complex of proteins that connect the cytoskeleton to the extracellular matrix (Alderton et al, *Trends Cardiovascular Med.* 10(6):268–272 (2000)). Although gene therapy is the only cure for DMD it is believed that immune interventions may slow the progress of the disease. The reason for this is that there is evidence that immune cell interactions with dystrophin-deficient muscle can contribute to cell death in dystrophinopathies. It has also been shown that the population of immune cells in dystrophic muscle are not only different from those found that invade mechanically-damaged tissue; they are similar to those found in inflammatory disease such as polymyositis. Current research indicates that T cells may play a role in the pathology of dystrophin deficiency and that there may be an autoimmune component to the disease in which T cells are activated by a common antigen (Spencer et al, *Neuromuscular Disord.* 11(6–7):556–564 (2001)).

U.S. Pat. No. 5,834,030 (Bolton) describes a process for treating a patient to combat peripheral vascular disease, which comprises extracting an aliquot of the patient's blood, treating the blood aliquot extracorporeally with stressors such as an oxidative environment (ozone/oxygen gas mixture bubbled there through), incident UV light and an elevated temperature.

U.S. Pat. No. 5,980,954 (Bolton) describes similar processes for treating autoimmune diseases in mammalian patients.

It is an object of the present invention to provide a novel treatment or prophylaxis of neurological disorders which have a significant inflammatory component, such as chronic inflammatory demyelinating polyneuropathy and Guillain-Barré syndrome.

“Immune modulation therapy” as the term is used herein, is an ex vivo treatment protocol which involves exposure of autologous peripheral blood to combinations of at least two physicochemical stressors, namely heat, oxidative stress such as ozonation and electromagnetic radiation such as ultraviolet irradiation and subsequent administration of the treated blood to the patient, suitably by intramuscular injection. There is recent evidence that such immune modulation therapy suppresses contact hypersensitivity (Shivji et al., 2000) as well as demonstrating an attenuated hyperthermic response to immobilisation stress in spontaneously hypertensive rats (Kouamé et al., 1997) thus suggesting a possible protective role. In support of this is the report that following such immune modulation therapy a reduction in the relative number of pro-inflammatory TH1 cells and an increase in TH2 cells have been observed in humans, signifying a reduction in the inflammatory response (Rabinovitch et al., 1998).

#### SUMMARY OF THE INVENTION

This invention is directed to the surprising and unexpected discovery that such immune modulation therapy can exert beneficial anti-inflammatory effects across the blood-brain barrier of a mammalian patient, apparently through a significant reduction of the accumulation of reactive oxygen species and/or a significant down-regulation of associated inflammatory cytokines such as TNF- $\alpha$ , particularly in the cortical tissue of mammals. Accordingly, the therapy is suitable for either prophylactic or therapeutic treatment of the inflammatory component of neurological brain diseases such as Down's syndrome, epilepsy, Huntington's disease and brain traumas, through mediation of the development or activity of reactive oxygen species which play a role in the development or manifestation of such inflammation.

The present invention also provides for a method for the prophylactic or therapeutic treatment of inflammatory components and inflammatory aspects of a neurological disease in a mammalian patient diagnosed with or at risk of a neurological disease, which method comprises:

administering to said patient an aliquot of blood which has been treated *ex vivo* with at least two stressors selected from the group consisting of an oxidative environment, thermal stress and electromagnetic radiation, wherein the concentration of the reactive oxygen species in neuronal cells or tissues of said patient is reduced, with associated reduction of harmful inflammatory effects therein.

From another aspect, the present invention provides a process for alleviating the symptoms of a neurological brain disorder having a significant inflammatory component associated with excess active oxygen species (reactive oxygen species and oxidative free radicals), such as Down's syndrome, Huntington's disease, epilepsy and brain traumas, which comprises scavenging of active oxygen species from the brain of a mammalian patient by administering to said patient an aliquot of blood which has been treated *ex vivo* with at least two stressors selected from the group consisting of an oxidative environment, thermal stress and electromagnetic radiation.

Accordingly, the present invention is also a method of alleviation, prophylaxis against or preconditioning to hinder the onset and progression of neurodisorders which have a significant inflammatory component, such as Guillain-Barré syndrome (GBS), chronic inflammatory demyelinating polyneuropathy (CIPD), myasthenia gravis (MG), dermatomyositis, polymyositis, inclusion body myositis, post stroke, neurosarcooidosis, vascular dementia, closed head trauma, vasospasm, subarachnoid hemorrhage, adrenal leukocytic dystrophy (storage disorders), inclusion body dermatomyositis, minimal cognitive impairment and duchenne muscular dystrophy, wherein said method comprises treating a patient suffering from or at risk to contract such a disorder and having impaired endothelial function at the blood vessels, to improve the performance of endothelial function at the blood-brain barrier or at the blood-nerve barrier towards restoration of normal endothelial function. This represents a novel and innovative approach to the management and treatment of neurological disorders.

#### BRIEF DESCRIPTION OF THE DRAWINGS

In the accompanying drawing:

FIG. 1 is a graphical presentation of the effect of the treatment according to a preferred embodiment of the invention on the body weight of test animals, as described in the specific experimental section below. VasoCare™ therapy does not significantly alter body weight (FIG. 1a) or dose of urethane administered to induce anaesthesia (FIG. 1b) but there is an increase in the amplitude required to induce an action potential (FIG. 1c). Data is expressed as means with standard errors. FIG. 1d illustrates a mean pre-tetanus EPSP slope.

FIG. 2 is a graphical presentation of the results of testing LPS-induced impairment of LTP described in the experimental section below.

FIG. 3 is a graphical presentation of the measurements of reactive oxygen species accumulation described in the experimental section below. Data is expressed as means with standard errors. The \* indicates  $p < 0.05$  calculated according to the Student t-test for independent means.

FIG. 4 is a graphic presentation of the inflammatory cytokine TNF<sub>2</sub> measurements and anti-inflammatory cytok-

ine IL-10 measurements in the cortex of test animals, described in the experimental section below. Data is expressed as means with standard errors. The \*\* indicates  $p < 0.01$  calculated according to the Student t-test for independent means.

FIG. 5 is a graphical presentation of the measurements of c-Jun NH<sub>2</sub>-terminal kinase (JNK) activity in the cortex of experimental animals treated as described in the experimental section below. Data is expressed as means with standard errors. The \* indicates  $p < 0.05$  calculated according to the Student t-test for independent means.

FIG. 6 is a graphical presentation of the results of measurements of IL-1 Receptor Type 1 concentration in cortical tissue of test animals treated as described in the experimental section below. Data is expressed as means with standard errors.

#### THE PREFERRED EMBODIMENTS

In one of the preferred methods of this invention, a patient having a neurological disease condition with a significant inflammatory component mediated by reactive oxygen species, or at risk of developing such a brain disease condition, is first identified. Such patient may have a risk which is significantly greater than the risk in the average population, e.g. as a result of prior trauma, hereditary indication and the like. That patient is then evaluated to determine whether that disease condition or risk of disease condition can be effectively treated by reducing the concentration of reactive oxygen species. If in the opinion of the attending clinician, a reduction in the concentration of reactive oxygen species and associated reduction in neurological inflammation would be suitable for the prophylactic or therapeutic treatment of such a neurological disease, immune modulation therapy is administered to said patient.

Accordingly, in one of its preferred aspects, this invention is directed to a method for the prophylactic or therapeutic treatment of the inflammation-associated aspects of a neurological disease having a significant inflammatory component and mediated at least in part by reactive oxygen species, which method comprises:

(a) identifying a patient having a neurological brain disease condition or at risk of developing a neurological brain disease condition having a significant inflammatory component and mediated by reactive oxygen species;

(b) evaluating the patient identified in (a) above to determine whether that disease condition or risk of disease condition can be effectively treated by reducing the concentration of reactive oxygen species; and

(c) if a reduction in the concentration of reactive oxygen species would be suitable for the prophylactic or therapeutic treatment of such a disease, then

(d) administering to said patient an aliquot of blood which has been treated *ex vivo* with at least two stressors selected from the group consisting of an oxidative environment, thermal stress and electromagnetic radiation,

wherein, following such administration, the neurological brain tissue inflammation and/or the concentration of the reactive oxygen species in the neurological brain tissue of said patient is reduced.

The patient is a mammal and preferably a human.

The aliquot of blood is treated by being subjected to stressors which have been found to modify the blood. According to the present invention, the blood aliquot can be modified by subjecting the blood, or separated cellular or non-cellular fractions of the blood, or mixtures of the separated cells and/or non-cellular fractions of the blood, to

stressors selected from temperature stressors, electromagnetic emissions and oxidative environments, or any combination of such stressors, simultaneously or sequentially.

#### DETAILED DESCRIPTION OF THE INVENTION

The following terms are defined with respect to this invention:

“Therapeutic treatment” refers to the treatment of a disease wherein the treatment reduces or eliminates the symptoms of that disease.

“Prophylactic treatment” or “prophylaxis” refers to the prevention or hindrance of development of disease.

The terms “aliquot,” “aliquot of blood” or similar terms used herein include whole blood, separated cellular fractions of the blood including platelets, separated non-cellular fractions of the blood including plasma, and combinations thereof.

#### Methodology

The method of this invention provides for the prophylactic or therapeutic treatment of a neurological brain disease mediated by reactive oxygen species. In this method a patient is first identified as having such a disease condition or is at risk of having such a disease condition mediated by reactive oxygen species. The patient is then evaluated to determine whether that disease condition or risk of disease condition can be effectively treated by reducing the concentration of reactive oxygen species. Such evaluation is made by the attending clinician based upon the disease to be treated and the progression of the disease. Such factors are well within the skill of the art. If, in the opinion of the attending clinician, a reduction in the concentration of reactive oxygen species would be suitable for the prophylactic or therapeutic treatment of such a disease, then the patient is administered an aliquot of blood which has been treated *ex vivo* with at least two stressors selected from the group consisting of an oxidative environment, thermal stress and electromagnetic radiation. The *ex vivo* treatment of the aliquot of blood is described below. The method provides a reduced concentration of the reactive oxygen species in said patient.

In this preferred method, the patient is evaluated to determine whether the neurological brain disease condition or risk of neurological brain disease condition could be effectively treated by reducing the concentration of reactive oxygen species, e.g. whether its inflammation component associated with the presence of reactive oxygen species can be effectively reduced by reducing the concentration of reactive oxygen species. In this regard, the reduction of the reactive oxygen species is reduced in the patient at the time when a reduction of reactive oxygen species effectively treats (either prophylactically or therapeutically) the disease.

The concentration of reactive oxygen species may be measured by a variety of methods known in the art. For example, one can determine them from measurements of depletion of anti-oxidative enzymes (glutathione, catalase) in the patient's blood (see Layton et. al.). An alternative is to test the serum of a patient for oxidized low density lipoproteins, using anti-oLDL ELISA immunoassay (see Wilburgur et. al.). One can also measure lipid peroxidation products such as tiabarbituric acid and its derivatives in plasma, or measure arachidonic acid oxidation products in a patient's blood.

The treated blood is administered to the mammal by a method suitable for vaccination selected from the group

consisting of intra-arterial injection, intramuscular injection, intravenous injection, subcutaneous injection, intraperitoneal injection, and oral, nasal or rectal administration. Intramuscular injection is preferred.

#### 5 *Ex vivo* Treatment of Blood

According to a preferred process of the present invention, an aliquot of blood is extracted from a mammalian subject, preferably a human, and the aliquot of blood is treated *ex vivo* with certain stressors, described in more detail below. The effect of the stressors is to modify the blood, and/or the cellular or non-cellular fractions thereof, contained in the aliquot. The modified aliquot is then re-introduced into the subject's body by any route suitable for vaccination.

15 The stressors to which the aliquot of blood is subjected *ex vivo* according to the method of the present invention are selected from temperature stress (blood temperature above or below body temperature), an oxidative environment and an electromagnetic emission, individually or in any combination, simultaneously or sequentially. Suitably, in human subjects, the aliquot has a volume sufficient that, when re-introduced into the subject's body, at least partial alleviation of the reactive oxygen species mediated disorder is achieved in the subject.

25 Preferably, the volume of the aliquot is up to about 400 ml, preferably from about 0.1 to about 100 ml, more preferably from about 5 to about 15 ml, even more preferably from about 8 to about 12 ml, and most preferably about 10 ml, along with an anticoagulant, e.g., 2 ml sodium citrate.

30 It is preferred, according to the invention, to apply all three of the aforementioned stressors simultaneously to the aliquot under treatment, in order to ensure the appropriate modification to the blood. It may also be preferred in some embodiments of the invention to apply any two of the above stressors, for example to apply temperature stress and oxidative stress, temperature stress and an electromagnetic emission, or an electromagnetic emission and oxidative stress. Care must be taken to utilize an appropriate level of the stressors to thereby effectively modify the blood to alleviate the reactive oxygen species mediated disorder in the subject.

40 The temperature stressor warms the aliquot being treated to a temperature above normal body temperature or cools the aliquot below normal body temperature. The temperature is selected so that the temperature stressor does not cause excessive hemolysis in the blood contained in the aliquot and so that, when the treated aliquot is injected into a subject, alleviation of the reactive oxygen species mediated disorder will be achieved. Preferably, the temperature stressor is applied so that the temperature of all or a part of the aliquot is up to about 55° C., and more preferably in the range of from about -5° C. to about 55° C.

55 In some preferred embodiments of the invention, the temperature of the aliquot is raised above normal body temperature, such that the mean temperature of the aliquot does not exceed a temperature of about 55° C., more preferably from about 40° C. to about 50° C., even more preferably from about 40° C. to about 44° C., and most preferably about 42.5±1° C.

60 In other preferred embodiments, the aliquot is cooled below normal body temperature such that the mean temperature of the aliquot is within the range of from about -5° C. to about 36.5° C., more preferably from about 10° C. to about 30° C., and even more preferably from about 15° C. to about 25° C.

The oxidative environment stressor can be the application to the aliquot of solid, liquid or gaseous oxidizing agents.

Preferably, it involves exposing the aliquot to a mixture of medical grade oxygen and ozone gas, most preferably by bubbling through the aliquot, at the aforementioned temperature range, a stream of medical grade oxygen gas having ozone as a minor component therein. The ozone content of the gas stream and the flow rate of the gas stream are preferably selected such that the amount of ozone introduced to the blood aliquot, either on its own or in combination with other stressors, does not give rise to excessive levels of cell damage such that the therapy is rendered ineffective.

Suitably, the gas stream has an ozone content of up to about 300  $\mu\text{g/ml}$ , preferably up to about 100  $\mu\text{g/ml}$ , more preferably about 30  $\mu\text{g/ml}$ , even more preferably up to about 20  $\mu\text{g/ml}$  particularly preferably from about 10  $\mu\text{g/ml}$  to about 20  $\mu\text{g/ml}$ , and most preferably about 14.5 $\pm$ 1.0  $\mu\text{g/ml}$ . The gas stream is suitably supplied to the aliquot at a rate of up to about 2.0 liters/min, preferably up to about 0.5 liters/min, more preferably up to about 0.4 liters/min, even more preferably up to about 0.33 liters/min, and most preferably about 0.24 $\pm$ 0.024 liters/min, at STP. The lower limit of the flow rate of the gas stream is preferably not lower than 0.01 liters/min, more preferably not lower than 0.1 liters/min, and even more preferably not lower than 0.2 liters/min.

The electromagnetic emission stressor is suitably applied by irradiating the aliquot under treatment from a source of an electromagnetic emission while the aliquot is maintained at the aforementioned temperature and while the oxygen/ozone gaseous mixture is being bubbled through the aliquot. Preferred electromagnetic emissions are selected from photonic radiation, more preferably UV, visible and infrared light, and even more preferably UV light. The most preferred UV sources are UV lamps emitting primarily UV-C band wavelengths, i.e., at wavelengths shorter than about 280 nm. Such lamps may also emit amounts of visible and infrared light. Ultraviolet light corresponding to standard UV-A (wavelengths from about 315 to about 400 nm) and UV-B (wavelengths from about 280 to about 315) sources can also be used. For example, an appropriate dosage of such UV light, applied simultaneously with the aforementioned temperature and oxidative environment stressors, can be obtained from lamps with a combined power output of from about 15 to about 25 watts, arranged to surround the sample container holding the aliquot, each lamp providing an intensity at a distance of one meter, of from about 45–65  $\text{mW/cm}^2$ . Up to eight such lamps surrounding the sample bottle, with a combined output at 253.7 nm of 15–25 watts, operated at an intensity to deliver a total UV light energy at the surface of the blood of from about 0.025 to about 10  $\text{joules/cm}^2$ , preferably from about 0.1 to about 3.0  $\text{joules/cm}^2$ , may advantageously be used. Preferably, four such lamps are used.

The time for which the aliquot is subjected to the stressors is normally within the time range of up to about 60 minutes. The time depends to some extent upon the chosen intensity of the electromagnetic emission, the temperature, the concentration of the oxidizing agent and the rate at which it is supplied to the aliquot. Some experimentation to establish optimum times may be necessary on the part of the operator, once the other stressor levels have been set. Under most stressor conditions, preferred times will be in the approximate range of from about 2 to about 5 minutes, more preferably about 3 or about 3½ minutes. The starting blood temperature, and the rate at which it can be warmed or cooled to a predetermined temperature, tends to vary from subject to subject. Such a treatment provides a modified blood aliquot which is ready for injection into the subject.

In the practice of the preferred process of the present invention, the blood aliquot may be treated with the stressors using an apparatus of the type described in U.S. Pat. No. 4,968,483 to Mueller. The aliquot is placed in a suitable, sterile, UV light-transmissive container, which is fitted into the machine. The UV lamps re switched on for a fixed period before the gas flow is applied to the aliquot providing the oxidative stress, to allow the output of the UV lamps to stabilize. The UV lamps are typically switched on while the temperature of the aliquot is adjusted to the predetermined value, e.g., 42.5 $\pm$ 1° C. Then the oxygen/ozone gas mixture, of known composition and controlled flow rate, is applied to the aliquot, for the predetermined duration of up to about 60 minutes, preferably 2 to 5 minutes and most preferably about 3 minutes as discussed above, so that the aliquot experiences all three stressors simultaneously. In this way, blood is appropriately modified according to the present invention to achieve the desired effects.

A subject preferably undergoes a course of treatments, such individual treatment comprising removal of a blood aliquot, treatment thereof as described above and re-administration of the treated aliquot to the subject. A course of such treatments may comprise daily administration of treated blood aliquots for a number of consecutive days, or may comprise a first course of daily treatments for a designated period of time, followed by an interval and then one or more additional courses of daily treatments.

In one preferred embodiment, the subject is given an initial course of treatments comprising the administration of 4 to 6 aliquots of treated blood. In another preferred embodiment, the subject is given an initial course of therapy comprising administration of from 2 to 4 aliquots of treated blood, with the administration of any pair of consecutive aliquots being either on consecutive days, or being separated by a rest period of from 1 to 21 days on which no aliquots are administered to the patient, the rest period separating one selected pair of consecutive aliquots being from about 3 to 15 days. In a more specific, preferred embodiment, the dosage regimen of the initial course of treatments comprises a total of three aliquots, with the first and second aliquots being administered on consecutive days and a rest period of 11 days being provided between the administration of the second and third aliquots.

It may be preferred to subsequently administer additional courses of treatments following the initial course of treatments. Preferably, subsequent courses of treatments are administered at least about three weeks after the end of the initial course of treatments. In one particularly preferred embodiment, the subject receives a second course of treatment comprising the administration of one aliquot of treated blood every 30 days following the end of the initial course of treatments, for a period of 6 months.

It will be appreciated that the spacing between successive courses of treatments should be such that the positive effects of the treatment of the invention are maintained, and may be determined on the basis of the observed response of individual subjects.

## EXAMPLES

The invention is demonstrated and illustrated by the following animal experiments, conducted on Wistar rats, according to ethically-approved procedures and protocols.

The experiments investigated the effect of pre-treatment of peripheral blood exposed to immune modulation therapy on LPS-induced impairment of LTP in rat hippocampal tissue. Preliminary studies were also carried out in cortical

tissue to explore the consequence of immune modulation therapy on the accumulation of ROS, the concentration of the cytokines TNF $\alpha$  and IL-10, as well as IL-1 receptor type I, and on the activity of the stress-activated protein kinase, JNK.

### Experimental Procedure

#### Animals

Four groups of eight male Wistar rats (300–350 g; BioResources Unit, Trinity College Dublin, Republic of Ireland) were used in these experiments. Animals were housed in groups of four under a 12-hour light schedule, ambient temperature was controlled between 22 and 23° C. and rats were maintained under veterinary supervision.

#### Treatment Protocol

Whole blood was obtained by cardiac puncture from donor rats and anticoagulated with sodium citrate (10 ml of blood+2 ml of 3.13% sodium citrate solution). The anticoagulated blood was divided into two aliquots; 2 ml to be used for sham treatment and 10 ml to undergo immune modulation treatment. For immune modulation treatment, 10 ml of anticoagulated blood was transferred to a custom-built sterile, low-density polyethylene disposable blood container (Vasogen Inc, Toronto, ON, Canada) and exposed to a combination of controlled physiochemical stress factors in a medical device (Vasogen Inc).

During processing, the temperature of the blood was raised to 42.5° C., during which time blood was exposed to UV light (maximum emission spectrum at 254 nm). When this temperature was reached, a gas mixture of 14.5 $\pm$ 1.0  $\mu$ g/mL of ozone in medical oxygen was bubbled through the blood at a flow rate of 240 $\pm$ 24 mL per min for 3 minutes, after which time the heat and UVC light sources were turned off. The foaming action caused by bubbling the gas through the blood increased the surface area exposed to the UVC light. The blood was then allowed to settle to the bottom of the blood container and was then ready to be used. Two groups of 16 rats were treated by intramuscular injection with 150  $\mu$ L of processed blood or untreated blood (sham treatment). Injections were administered 14 days, 13 days and 1 day before LPS challenge/induction of LTP.

#### Induction of LTP in Perforant Path-Granule Cell Synapses In Vivo

Rats were anesthetized by intraperitoneal injection of urethane (1.5 g/kg). All rats received LPS (100  $\mu$ g/kg) or saline, intraperitoneally and monitored for 3 h. A bipolar stimulating electrode and a unipolar recording electrode were placed in the perforant path (4.4 mm lateral to Lambda) and in the dorsal cell body region of the dentate gyrus (2.5 mm lateral and 3.9 mm posterior to Bregma), respectively, and 0.033-Hz test shocks were given for 10 min before, and 40 min after, titanic stimulation (three trains of stimuli delivered at 30-s intervals, 250 Hz for 200 ms (McGahon & Lynch, 1996)). Rats were killed by decapitation; cross-chopped slices (350 $\times$ 350  $\mu$ m) were prepared from dentate gyri, entorhinal cortex, hippocampus and cortex and used to prepare dissociated cells (see below) or frozen separately in Krebs solution containing 10% dimethyl sulfoxide (Haan & Bowen, 1981) and stored at -80° C. For analysis, slices were thawed rapidly and rinsed in fresh oxygenated Krebs solution before preparation of homogenate or the crude synap-

#### Analysis of Reactive Oxygen Species Formation

The formation of reactive oxygen species was assessed by analyzing formation of the highly-fluorescent 2',7-dichlorofluorescein (DCF) from the non-fluorescent probe, 2',7-dichlorofluorescein diacetate (DCFH-DA; Molecular Probes, USA; LeBel et al., 1992). The synaptosomal pellet, P<sub>2</sub>, prepared from cortex, was resuspended in 1 mL ice-cold 40 mM Tris buffer (pH 7.4), incubated at 37° C. for 15 min with DCFH-DA (10  $\mu$ L; final concentration 5  $\mu$ M; from a stock solution of 500  $\mu$ M in methanol) and the reaction was terminated by centrifugation at 13,000 $\times$ g for 8 min at 4° C. Pellets were resuspended in 1.5 mL of ice-cold 40 mM Tris buffer, pH 7.4, and monitored for fluorescence at 37° C. (excitation, 488 nm; emission, 525 nm). Reactive oxygen species formation was quantified from a standard curve of DCF in methanol (range 0 to 5  $\mu$ M). Protein concentration was determined (Bradford, 1976) and the results were expressed as nmol/mg protein/min.

#### Analysis of TNF $\alpha$ and IL-10 Concentration

A commercially available Enzyme-linked immunosorbent assay was used to analyze cortical TNF $\alpha$  (Biosource International Inc.) and cortical IL-10 was measured using an IL-10 Cytoset Antibody Pair (Biosource International Inc.). Each tissue was added to 1 mL of Iscove's culture medium containing 5% fetal bovine serum and a cocktail enzyme inhibitor (100 mM amino-n-caproic acid, 10 mM Na<sub>2</sub>EDTA, 5 mM Benzamidine HCl, 0.2 mM phenylmethylsulfonyl fluoride). Tissue was homogenized and centrifuged at 10,000 rpm at 4° C. for 10 min. Supernatants were removed and analyzed for TNF $\alpha$  using ELISA. Protein concentration was determined (Bradford, 1976) and the results were expressed as pg/mg protein.

#### Analysis of JNK Activity and IL-1 Receptor Type I Concentration

JNK activity and IL-1 Receptor Type I concentration was analyzed using Western Blotting technique in samples prepared from cortical tissue. Tissue homogenates were diluted to equalize for protein concentration (Bradford, 1976) and 10  $\mu$ L aliquots (1 mg/mL) were added to 5  $\mu$ L of sample buffer (0.5 mM Tris-HCl, pH 6.8, 10% glycerol, 10% SDS, 5% b-mercaptoethanol, 0.05% bromophenol blue, w/v) and boiled for 5 min. Samples were frozen until Western Blotting was performed. 10  $\mu$ L of each sample was loaded onto gels (10% SDS) for each analysis. Proteins were separated by application of a 32-mA constant current for 25–30 min, transferred onto nitrocellulose strips (225 mA for 75 min), and immunoblotted with the appropriate antibody. To assess JNK activity, proteins were immunoblotted with an antibody that specifically targets phosphorylated JNK (Santa Cruz Biotechnology, Inc; 1:100 in TBS and 0.1% Tween 20 containing 1% BSA) for 2 h at room temperature.

IL-1 Receptor Type I concentration was assessed by immunoblotting proteins with a rabbit polyclonal antibody raised against an epitope mapping at the carboxy terminus of IL-1RI of mouse origin (Santa Cruz Biotechnology, Inc.; 1:2000 in PBS and 0.1% Tween 20 containing 2% non-fat dried milk) for 45 min at room temperature and 45 min at 37° C. Nitrocellulose strips were washed and incubated with secondary antibody [peroxide-linked anti-mouse IgG; 1:300 dilution (Sigma) for 2 h at room temperature in the case of JNK and with HRP-linked anti-rabbit antibody; 1:2000 dilution (Amersham, UK) for 60 min at room temperature and 30 min at 37° C. in the case of IL-1 Receptor Type I. Visualization of phosphorylated JNK was achieved using SuperSignal West Dura Extended Duration Substrate (Pierce, USA). Immunoblots were immersed in substrate for

15

5 min and subsequently exposed to film for 1 s. Protein complexes of IL-1 Receptor Type 1 were visualized by ECL detection (Amersham, UK) and immunoblots were exposed to film overnight at 4° C. In both cases films were processed using a Fuji x-ray processor. Quantification of protein bands was achieved by densitometric analysis using two software packages, Grab It (Grab It Annotating Grabber, version 2.04.7, Synotics; UVP Ltd) and Gelworks (Gelworks II, version 2.51; UVP Ltd) for photography and densitometry, respectively. Gelworks provides a single value (in arbitrary units) representing the density of each blot.

#### Analysis of Glutamate Release

Glutamate release was assessed in the impure synaptosomal preparation, P<sub>2</sub>, obtained from dentate gyrus; either freshly-prepared tissue was used or alternatively, P<sub>2</sub> was prepared from frozen slices of dentate gyri which were obtained from rats in which electrophysiological recordings were made (McGahon and Lynch, 1996). In both cases, P<sub>2</sub> preparations were resuspended in oxygenated Krebs solution containing 2 mM CaCl<sub>2</sub> and glutamate release was assessed as described previously (McGahon et al., 1996). Briefly, synaptosomal tissue was aliquotted onto Millipore filters (ø45 µm), rinsed under vacuum and the filtrate was discarded. Synaptosomes were then incubated in 250 µl oxygenated Krebs solution at 37° C. for 3 min, in the presence or absence of 40 mM KCl, and filtrate was collected and stored for analysis as described (Ordroneau et al., 1991). In some experiments, synaptosomes were incubated at 37° C. for 20 min in Krebs solution containing IL-1β (1 ng/ml) in the presence or absence of Vasoactive Intestinal Peptide (VIP; 1 µM). Triplicate samples (50 µl) or glutamate standards (50 µl; 25 nM to 1 µM prepared in 100 mM NaH<sub>2</sub>PO<sub>4</sub> buffer, pH 8.0) were added to glutaraldehyde-coated 96-well plates, incubated for 60 min at 37° C., and washed with 100 mM NaH<sub>2</sub>PO<sub>4</sub> buffer. Ethanolamine (250 µl; 0.1 M in 100 mM NaH<sub>2</sub>PO<sub>4</sub> 4 buffer) was used to bind unreacted aldehydes and donkey serum (200 µl; 3% in PBS-T) was added to block non-specific binding. Samples were incubated overnight at 4° C. in the presence of anti-glutamate antibody (raised in rabbit; 100 µl; 1:5,000 in PBS-T; Sigma, UK), washed and reacted with secondary antibody (anti-rabbit horseradish peroxidase (HRP)-linked secondary antibody; 100 µl; 1:10,000 in PBS-T; Amersham, UK) for 60 min at room temperature. 3,3', 4,4'-Tetramethylbenzidine liquid substrate was added as chromogen and incubation continued for exactly 60 min at room temperature, at which time the reaction was stopped by H<sub>2</sub>SO<sub>4</sub> (4 M; 30 µl). Optical densities were determined at 450 nm using a multiwell plate reader and values were calculated with reference to the standard curve, corrected for protein (Bradford, 1976) and expressed as µmol glutamate/mg protein.

#### Analysis of IL-1β Concentration

IL-1β concentration in hippocampal was analysed by ELISA (R & D Systems, UK). Antibody-coated (100 µl; 1.0 µg/ml final concentration, diluted in phosphate buffered saline (PBS), pH 7.3; goat anti-rat IL-1β antibody) 96-well plates were incubated overnight at room temperature, washed several times with PBS containing 0.05% Tween 20, blocked for 1 hour at room temperature with 300 µl blocking buffer, (PBS, pH 7.3 containing 5% sucrose, 1% bovine serum albumin (BSA), and 0.05% NaN<sub>3</sub>). After several washes, plates were incubated with IL-1β standards (100 µl; 0-1000 pg/ml in PBS containing 1% BSA) or samples (homogenized in Krebs solution containing 2 mM CaCl<sub>2</sub>) for 2 hours at room temperature. Samples were incubated with secondary antibody (100 µl; final concentration 350

16

ng/ml in PBS containing 1% BSA and 2% normal goat serum; biotinylated goat anti-rat IL-1β antibody) for 2 hours at room temperature, washed and incubated in detection agent (100 µl; horseradish peroxidase conjugated streptavidin; 1:200 dilution in PBS containing 1% BSA) for 20 min at room temperature. Substrate solution (100 µl; 1:1 mixture of H<sub>2</sub>O<sub>2</sub> and tetramethylbenzidine) was added, samples were incubated at room temperature in the dark for 1 hour after which time the reaction was stopped using 50 µl 1 M H<sub>2</sub>SO<sub>4</sub>. Absorbance was read at 450 nm, values were corrected for protein (Bradford, 1976) and expressed as pg IL-1β/mg protein.

#### TUNEL Staining

Dissociated cells were prepared by enzymatic and mechanical digestion of fresh hippocampal slices. Slices were incubated with collagenase (0.125%) in PBS for 30 min at room temperature, washed with PBS to terminate collagenase digestion, and then gently triturated with a glass Pasteur pipette, before passing through a nylon mesh filter to remove tissue clumps. Cells were then cytopspun onto glass microscope slides, fixed with methanol and stored until use.

TUNEL (Terminal deoxynucleotidyl Transferase (TdT)-mediated dUTP Nick-End Labeling) staining, which identifies nuclei with fragmented DNA (a characteristic of apoptotic cells), was performed according to the manufacturer's instructions. Briefly, fixed cytopspun cells were washed and permeabilized. Cells were equilibrated in buffer (200 mM potassium cacodylate (pH 6.6 at 25° C.), 25 mM Tris-HCl (pH 5.5 at 25° C.), 0.2 mM DTT, 0.25 mg/ml BSA, 2.5 mM CoCl<sub>2</sub>) for 5 min at room temperature and incubated in TdT reaction mixture (30 µl; 98 µl equilibration buffer, 1 µl biotinylated nucleotide mix, 1 µl TdT enzyme) at 37° C. for 1 hour. The reaction was terminated by adding 100 µl 2×SCC (1:10; 2×SCC:deionized water), endogenous peroxidases were blocked by incubating with H<sub>2</sub>O<sub>2</sub> (100 µl; 0.3% in PBS) for 5 min at room temperature, and washed cells were incubated for 30 min at room temperature in streptavidin HRP solution (100 µl; 1:500 in PBS) to allow binding to biotinylated nucleotides. Diaminobenzidine solution was added to washed cells, and the incubation proceeded for 10 min at room temperature. Cells were washed with deionised water, dehydrated through graded ethanol, and then cleared with xylene after which slides were mounted in DPX mounting medium and coverslipped. TUNEL positive cells were expressed as a percentage of the total.

#### Statistical Analysis

Data were analyzed, as appropriate, using either the Student's t-test for independent means, or by using a one-way analysis of variance (ANOVA) followed by post hoc analysis using the Student Newman Keuls test.

## RESULTS

### A: Hippocampus

Mean body weight, dose of urethane administered to induce anaesthesia, and stimulus strength required to induce an epsp spike were calculated. There was no significant difference between groups in body weight (FIG. 1A) or urethane concentration (FIG. 1B) administered due to immune modulation therapy.

FIG. 1 demonstrates that immune modulation therapy does not significantly alter body weight (a) or dose of urethane administered to induce anaesthesia (b). There is however an increase in the amplitude required to induce an action potential (c). The data are expressed as means with standard errors.

Tetanic stimulation delivered to the perforant path 3 h after intraperitoneal injection of LPS resulted in an increase in the mean slope of the population excitatory post-synaptic potential (epsp). The mean percentage change in the 2 min immediately following tetanic stimulation ( $\pm$ SEM; compared with the 5 min immediately before tetanic stimulation) was 114.49 ( $\pm$ 2.79), but this was not maintained so that the mean percentage change in population epsp slope in the last 5 min of the experiment was 90.32 ( $\pm$ 2.42). The corresponding values in the saline-treated control rats were 170.15 ( $\pm$ 10.16) and 121.28 ( $\pm$ 1.20), respectively (FIG. 2). The LPS induced inhibition of LTP was blocked by pre-treatment with immune modulation therapy.

FIG. 2 demonstrates that the LPS-induced impairment of LTP was inhibited by pre-treatment with immune modulation therapy. The mean population epsp slope immediately after tetanic stimulation was attenuated in LPS-treated rats compared with saline-treated rats and was close to baseline at the end of the 40 min post-tetanus recording period. The inhibitory effect of LPS on LTP was blocked by pre-treatment with immune modulation therapy, which exerted no significant effect in saline-challenged rats. The data presented are means of seven to eight observations in each treatment group.

The mean percentage change in population epsp slope ( $\pm$ SEM) in the 2 min immediately after tetanic stimulation was 166.85 ( $\pm$ 4.54) in the sham pretreated, saline challenged group compared with 147.44 ( $\pm$ 5.84) in the group pretreated with immune modulation therapy and challenged with LPS. In the last 5 min of the experiment the values were 121.96 ( $\pm$ 0.85) and 128.07 ( $\pm$ 1.46), respectively (n=7-8).

Dissociated cells prepared from fresh hippocampal tissue displayed an increased number of apoptotic cells after LPS injection as evidenced by increased number of cells displaying dark brown stained nuclei i.e. TUNEL positive cells. This contrasts with cells prepared from hippocampus of saline-treated rats and rats treated with immune modulation therapy. Treatment with immune modulation therapy reversed the effects of LPS as shown by a reduction in the number of cells displaying TUNEL positive staining. The percentage of TUNEL positive cells was significantly increased in the LPS-treated group compared with the control treated group (p<0.01; ANOVA) and demonstrates that the immune modulation therapy reversed the degenerative effect of LPS (p<0.01; ANOVA).

#### B: Cortex

Animals were administered either immune modulation therapy or sham treatments, as previously described, and the following measurements were made in the cortex: ROS accumulation, TNF- $\alpha$  and IL-10 levels. These experiments were performed without LPS stimulation of the animals.

FIG. 3 indicates that immune modulation therapy significantly reduces reactive oxygen species accumulation in the cortex (p<0.05; student's t-test for independent means, n=7-8). The data are expressed as means with standard errors.

The concentration of pro-inflammatory cytokine, TNF $\alpha$  is significantly reduced in the cortex as a result of immune modulation therapy (p<0.01; student's t-test for independent means, FIG. 4a). In contrast, IL-10 concentration is significantly increased (p<0.01; student's t-test for independent means) (FIG. 4b). FIGS. 4a and 4b show that immune modulation therapy significantly reduces TNF $\alpha$  concentration (a) and significantly increases IL-10 concentration (b) in

the cortex (p<0.01; student's t-test for independent means; n=7-8). The data are expressed as means with standard errors.

FIG. 5 illustrates that immune modulation therapy decreased JNK activity as indicated by a decrease in the phosphorylated form of JNK. Analysis of the mean data obtained from densitometric analysis indicated that Vasocare™ therapy significantly reduced kinase activity (p<0.05; student's t-test for independent means). FIG. 5 shows that immune modulation therapy significantly reduces JNK activity in the cortex (p<0.05; student's t-test for independent means; n=7-8). The data are expressed as means with standard errors.

With respect to the concentration of IL-1 Receptor Type I in cortical tissue, pilot work indicates that immune modulation therapy reduces IL-1 Receptor Type I expression (FIG. 6). The concentration of ligand pro-inflammatory IL-1 $\beta$  itself is expected to be lower, and is under examination. FIG. 6 shows that immune modulation therapy reduces the concentration of IL-1 Receptor Type I (preliminary data; n=3). The data are expressed as means with standard errors.

Analysis of endogenous glutamate release in synaptosomes prepared from tetanized and untetanzied tissue obtained from these rats revealed a significant effect of LPS injection. Addition of 40 mM KCl to synaptosomes prepared from untetanzied dentate gyrus obtained from saline-treated control rats, significantly increased glutamate release (p<0.05; Student t-test for paired means) albeit to an attenuated degree. This immune modulation therapy reversed the LPS-induced blockage of KCl stimulated glutamate release in untetanzied dentate gyrus and to a more significant degree in tetanized tissue (p<0.01; Student t-test for paired means). This immune modulation therapy may exert its protective effect on syncystic function by acting to prevent this LPS-induced signaling event.

#### BIBLIOGRAPHY

- Bliss T V, Collingridge G L. A synaptic model of memory: long-term potentiation in the hippocampus. *Nature*. 1993 361(6407):31-9.
- Bradford M M. A rapid and sensitive method for the quantitation of microgram quantities of protein utilizing the principle of protein-dye binding. *Anal Biochem*. 1976 72:248-54.
- Green L N. Corticosteroids in the treatment of Sydenham's chorea. *Arch. Neurol*. January 1978; 35(1): 53-4.
- Haan E A, Bowen D M. Protection of neocortical tissue prisms from freeze-thaw injury by dimethyl sulphoxide. *J Neurochem*. 1981 37(1):243-6.
- Kedziora J, Bartosz G. Down's syndrome: a pathology involving the lack of balance of reactive oxygen species. *Free Radic. Biol. Med.*, 1988; 4(5): 317-30.
- Kouamé N, Carioto S, Hamet P, Tremblay J. Vasocare-therapy attenuates telemetered temperature response to stress in SHR. 9<sup>th</sup> International Symposium on SHR and Cardiovascular Genetics, Montreal, Canada, #P-136, Nov. 13-16, 1997.
- Layton M E, Pazdernik T L. Reactive oxidant species in piriform cortex extracellular fluid during seizures induced by systemic kainic acid in rats. *J. Mol. Neurosci* August-October 1999, 13(1-2): 63-8.
- LeBel C P, Ischiropoulos H, Bondy S C. Evaluation of the probe 2',7'-dichlorofluorescein as an indicator of reactive oxygen species formation and oxidative stress. *Chem Res Toxicol*. 1992 5(2):227-31.

- Maroney A C, Glicksman M A, Basma A N, Walton K M, Knight E, Murphy C A, Bartlett B A, Finn J P, Angeles T, Matsuda Y, Neff N T, Dionne C A. Motoneuron apoptosis is blocked by CEP-1347 (KT 7515), a novel inhibitor of the JNK signaling pathway. *J Neurosci.* 1998 18(1): 104-11.
- Martin D S D, Towey M, Horrobin D F, Lynch M A. A diet enriched in  $\alpha$ -lipoic acid reverses the age-related compromise in antioxidant defenses in rat cortical tissue. *Nutritional Neuroscience* 2000 3: 193-206.
- McGahon B, Lynch M A. The synergism between metabotropic glutamate receptor activation and arachidonic acid on glutamate release is occluded by induction of long-term potentiation in the dentate gyrus. *Neuroscience.* 1996 72(3):847-55.
- Mogi M, Harada M, Narabayashi H, Inagaki H, Minami M, Nagatsu T. Interleukin (IL)-1b, IL-2, IL-4, IL-6 and transforming growth factor- $\alpha$  levels are elevated in ventricular cerebrospinal fluid in juvenile parkinsonism and Parkinson's disease. *Neurosci Lett.* 1996 211(1):13-6.
- Murray C A, Lynch M A. Evidence that increased hippocampal expression of the cytokine interleukin-1b is a common trigger for age- and stress-induced impairments in long-term potentiation. *J Neurosci.* 1998 18(8):2974-81.
- O'Donnell E, Vereker E, Lynch M A. Age-related impairment in LTP is accompanied by enhanced activity of stress-activated protein kinases: analysis of underlying mechanisms. *Eur J Neurosci.* 2000 12(1):345-52.
- Park D S, Stefanis L, Yan C Y, Farinelli S E, Greene L A. Ordering the cell death pathway. Differential effects of BCL2, an interleukin-1-converting enzyme family protease inhibitor, and other survival agents on JNK activation in serum/nerve growth factor-deprived PC12 cells. *J Biol Chem.* 1996 271(36):21898-905.
- Rabinovitch B A, Matukas L, Raju K, Punhani T, deVeber G, Keystone E. VasoCare™ PSC1 normalizes the Th2 cell subset in scleroderma. XII Pan-American Congress of Rheumatology, Montreal, Canada, 1998.
- Schuchmann S, Heinemann U. Increased mitochondrial superoxide generation in neurons from trisomy 16 mice: a model of Down's syndrome. *Free Radic. Biol. Med.* Jan. 15, 2000; 28(2): 235-50.
- Shivji G M, Suzuki H, Mandel A S, Bolton A E, Sauder D N. The effect of VAS972 on allergic contact hypersensitivity. *J Cutan Med Surg.* 2000 4(3):132-7.
- Temetti L, D'Emilia D M, Troy C M, Lipton S A. Role of caspases in N-methyl-D-aspartate-induced apoptosis in cerebrocortical neurons. *J Neurochem.* 1998 71(3):946-59.
- Trembovler V, Beit-Yannai E, Younis F, Gallily R, Horowitz M, Shohami E. Antioxidants attenuate acute toxicity of tumor necrosis factor- $\alpha$  induced by brain injury in rat. *J. Interferon Cytokine Res* July 1999; 19(7): 791-5.
- Vereker E, Campbell V, Roche E, McEntee E, Lynch M A. Lipopolysaccharide inhibits long term potentiation in the rat dentate gyrus by activating caspase-1. *J Biol Chem.* 2000a 275(34):26252-8.
- Vereker E, O'Donnell E, Lynch M A. The inhibitory effect of interleukin-1b on long-term potentiation is coupled with increased activity of stress-activated protein kinases. *J Neurosci.* 2000b 20(18):6811-9.
- Wildburger R, Borovic S, Zarkovic N, and Tatzber F. Post-traumatic dynamic changes in the antibody titer against oxidized low density lipoproteins. *Wien Klin Wochenshr* Sep. 29, 2000; 112(18) 798-803.

What is claimed is:

1. A method for inhibiting the production of reactive oxygen species in a mammalian patient produced by neurological diseases selected from the group consisting of Down's syndrome, Huntington's disease, brain trauma and epilepsy, chronic inflammatory demyelinating polyneuropathy, Guillain-Barré syndrome, myasthenia gravis, dermatomyositis, polymyositis, inclusion body myositis, post stroke, neurosarcooidosis, vascular dementia, closed head trauma, vasospasm, subarachnoid hemorrhage, adrenal leukocytic dystrophy, inclusion body dermatomyositis, minimal cognitive impairment and duchenne muscular dystrophy, which method comprises:
  - administering to said patient an aliquot of blood which has been treated ex vivo with at least two stressors selected from the group consisting of an oxidative environment, thermal stress and electromagnetic radiation;
  - wherein the concentration of the reactive oxygen species in said patient is reduced.
2. The method of claim 1, wherein the oxidative environment comprises applying an oxidizing agent to the aliquot.
3. The method of claim 2, wherein the oxidative environment comprises a mixture of ozone gas and medical grade oxygen, the ozone gas being contained in the mixture in a concentration of up to about 300  $\mu$ g/ml.
4. The method of claim 3, wherein the ozone gas is contained in the mixture in a concentration of up to about 30  $\mu$ g/ml.
5. The method of claim 4, wherein the ozone gas being contained in the mixture in a concentration of from about 13.5  $\mu$ g/ml to about 15.5  $\mu$ g/ml.
6. The method of claim 3, wherein the mixture is applied to the aliquot at a flow rate of up to about 0.33 liters/mm.
7. The method of claim 6, wherein the mixture is applied to the aliquot at a flow rate of from about 0.21 liters/mm to about 0.27 liters/mm.
8. The method of claim 1, wherein the electromagnetic radiation comprises ultraviolet light having one or more UV-C band wavelengths.
9. The method of claim 1, wherein the thermal stressor is applied so that the temperature of at least part of the aliquot is in the range of from about  $-5^{\circ}$  C. to about  $55^{\circ}$  C.
10. The method of claim 1, wherein the thermal stressor provides for a mean temperature of the blood in the aliquot in the range of from about  $37^{\circ}$  C. to about  $44^{\circ}$  C.
11. The method of claim 1, wherein the thermal stressor provides for a mean temperature of the blood in the aliquot in the range of from about  $0^{\circ}$  C. to about  $36.5^{\circ}$  C.
12. The method of claim 1, wherein the thermal stressor provides for a mean temperature of the blood in the aliquot in the range of from about  $10^{\circ}$  C. to about  $30^{\circ}$  C.
13. The method of claim 1, wherein the thermal stressor provides for a temperature in the range of from about  $37^{\circ}$  C. to about  $55^{\circ}$  C.
14. The method of claim 13, wherein the temperature is  $42.5 \pm 1^{\circ}$  C.
15. The method of claim 1, wherein the aliquot has a volume of up to about 400 ml.
16. The method of claim 15, wherein the volume of the aliquot is about 10 ml.
17. The method of claim 16, wherein the volume of the aliquot is about 2 ml.
18. The method of claim 1, wherein the aliquot is subjected to the stressors for a period of up to about 60 minutes.



**21**

19. The method of claim 18, wherein the aliquot is subjected to the stressors for a period of about 3 minutes.

20. The method of claim 1, wherein the blood is administered to the mammal by a method suitable for vaccination selected from the group consisting of intra-arterial injection, intramuscular injection, intravenous injection, subcutaneous injection, intraperitoneal injection, and oral, nasal or rectal administration.

21. The method of claim 1, wherein all of the stressors are simultaneously administered to the aliquot.

22. The method of claim 21, wherein the mammal is a human.

23. The method of claim 1, wherein the neurological disease is minimal cognitive impairment.

**22**

24. The method of claim 1, wherein the neurological disease is post stroke.

25. The method of claim 1, wherein the neurological disease is vascular dementia.

26. The method of claim 1, wherein the neurological disease is chronic inflammatory demyelinating polyneuropathy.

27. The method of claim 1, wherein the neurological disease is Guillain-Barré syndrome.

28. The method of claim 1, wherein the neurological disease is brain trauma and epilepsy.

\* \* \* \* \*

UNITED STATES PATENT AND TRADEMARK OFFICE  
**CERTIFICATE OF CORRECTION**

PATENT NO. : 7,122,208 B2  
APPLICATION NO. : 10/115943  
DATED : October 17, 2006  
INVENTOR(S) : Anthony E. Bolton and Arkady Mandel

Page 1 of 1

It is certified that error appears in the above-identified patent and that said Letters Patent is hereby corrected as shown below:

On The Title Page Item (54):

Replace "COMPOSITIONS CONTAINING APOPTOTIC ENTITIES"

with

--METHODS FOR TREATING THE INFLAMMATORY COMPONENT OF A  
BRAIN DISORDER--

At COLUMN 1, LINES 1-2:

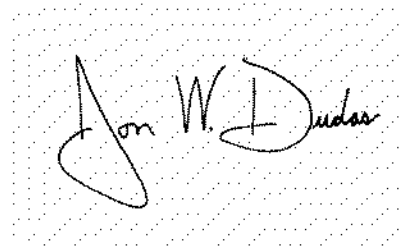
Replace "COMPOSITIONS CONTAINING APOPTOTIC ENTITIES"

with

--METHODS FOR TREATING THE INFLAMMATORY COMPONENT OF A  
BRAIN DISORDER--

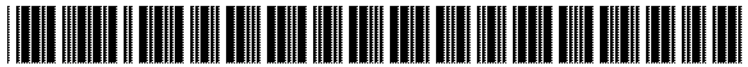
Signed and Sealed this

Seventeenth Day of July, 2007

A handwritten signature in black ink, reading "Jon W. Dudas", is written over a rectangular area with a light gray dotted background.

JON W. DUDAS

*Director of the United States Patent and Trademark Office*



US 20020051766A1

(19) **United States**

(12) **Patent Application Publication** (10) **Pub. No.: US 2002/0051766 A1**

**Smith et al.** (43) **Pub. Date: May 2, 2002**

(54) **TREATMENT OF CONGESTIVE HEART FAILURE**

(30) **Foreign Application Priority Data**

Jan. 18, 2000 (CA) ..... 2,296,997

(76) Inventors: **Eldon R. Smith**, Calgary (CA);  
**Guillermo Torre-Amione**, Bellaire, TX  
(US)

**Publication Classification**

(51) **Int. Cl.<sup>7</sup>** ..... **A61K 48/00; A61K 33/00**

(52) **U.S. Cl.** ..... **424/93.7; 424/600**

Correspondence Address:

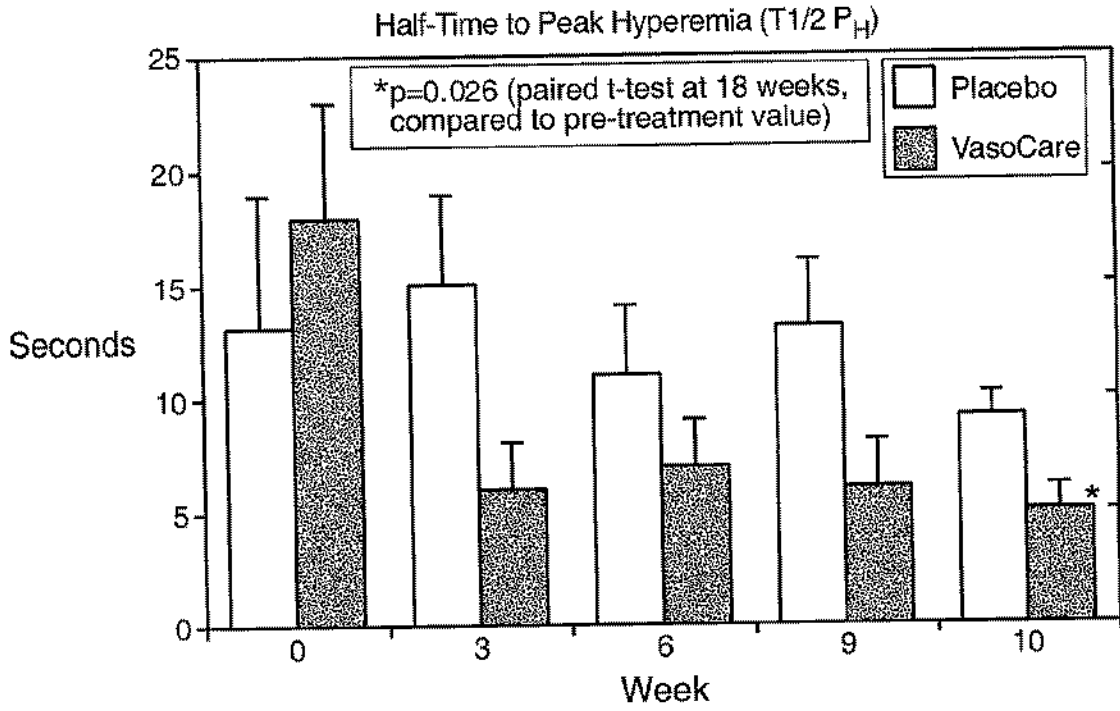
**Mr. Gerald F. Swiss**  
**Burns, Doane, Swecker & Mathis LLP**  
**Suite 700**  
**333 Twin Dolphin Drive**  
**Redwood Shores, CA 94065-1418 (US)**

(57) **ABSTRACT**

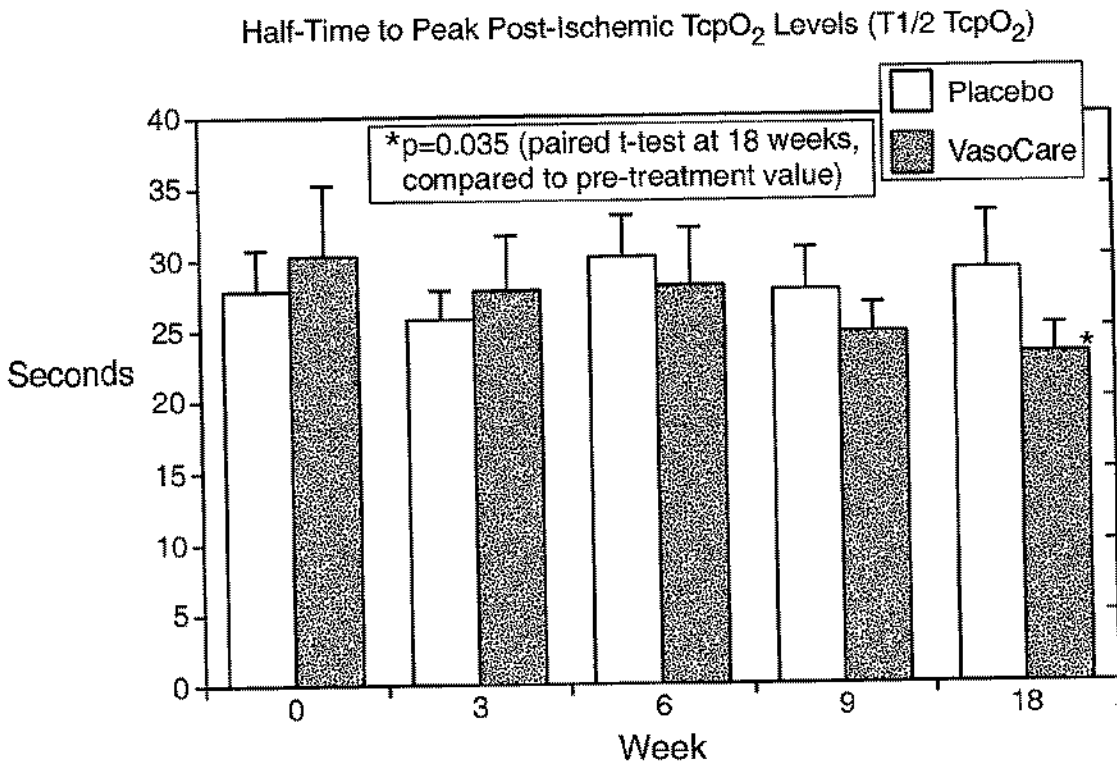
A method of treating congestive heart failure (CHF) in a human patient comprises treating an aliquot of the patient's blood ex vivo with at least one stressor selected from the group consisting of a temperature above or below body temperature, an electromagnetic emission and an oxidative environment, followed by administering the aliquot of treated blood to the patient. The treatment can be used on its own or as an adjunctive therapy in combination with conventional CHF treatments.

(21) Appl. No.: **09/760,600**

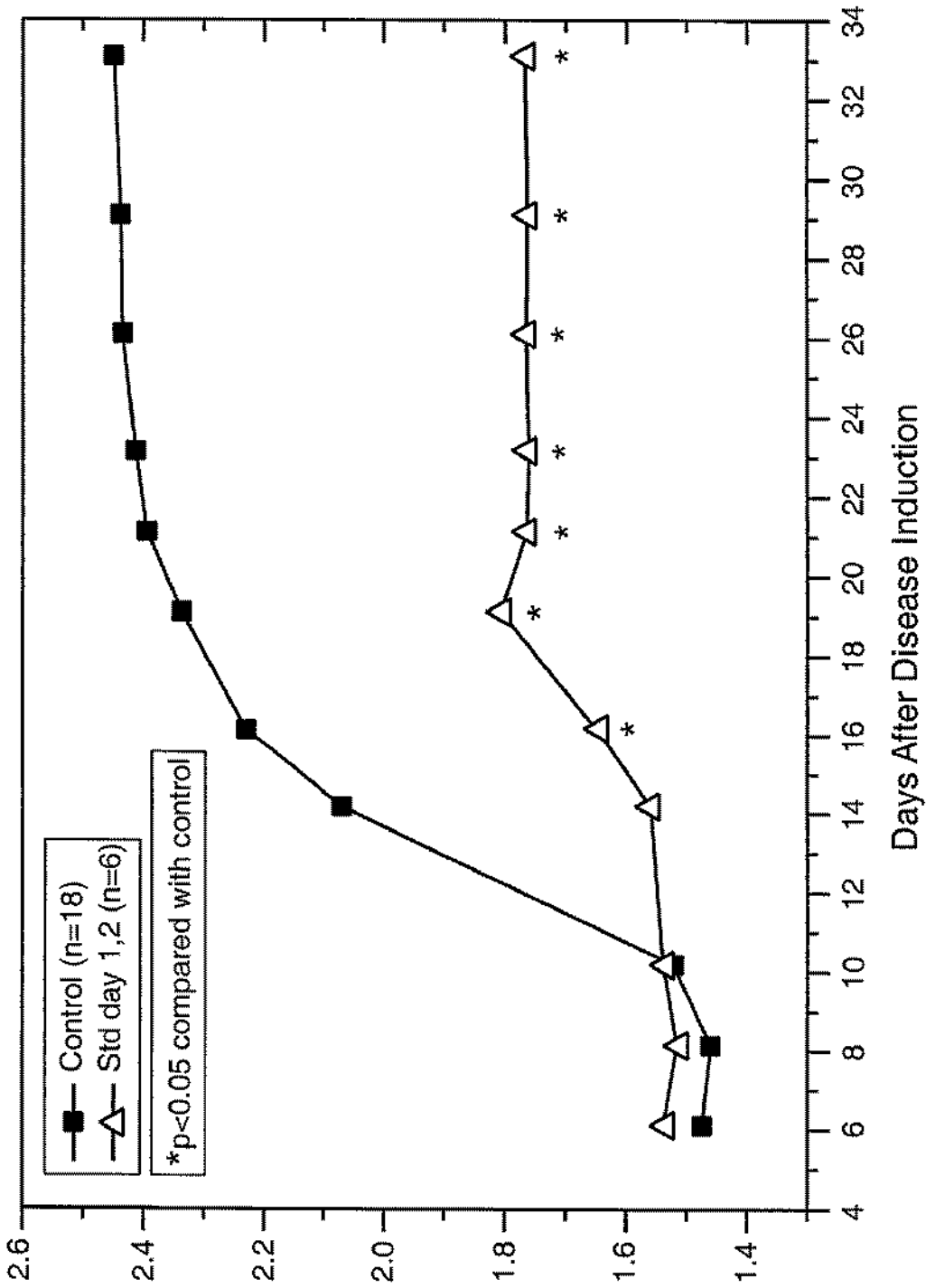
(22) Filed: **Jan. 17, 2001**



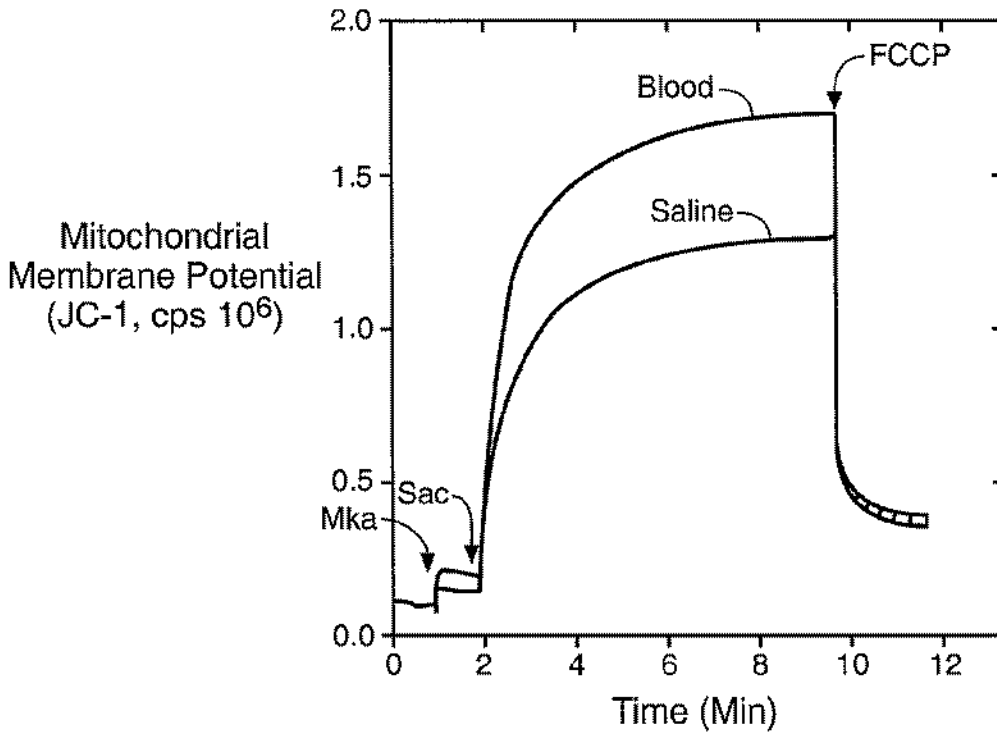
**FIG. 1**



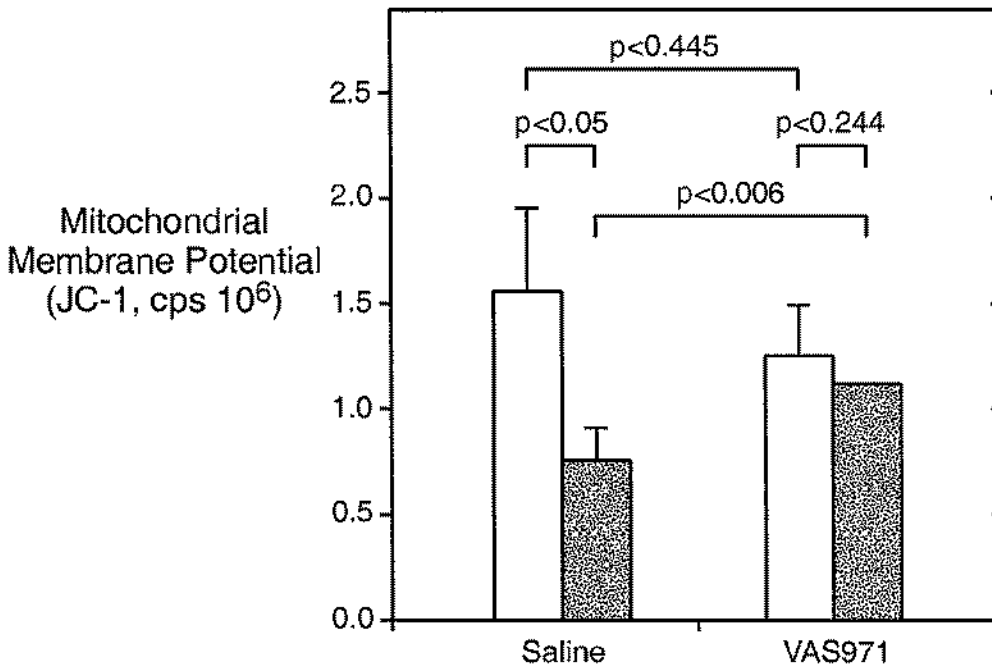
**FIG. 2**



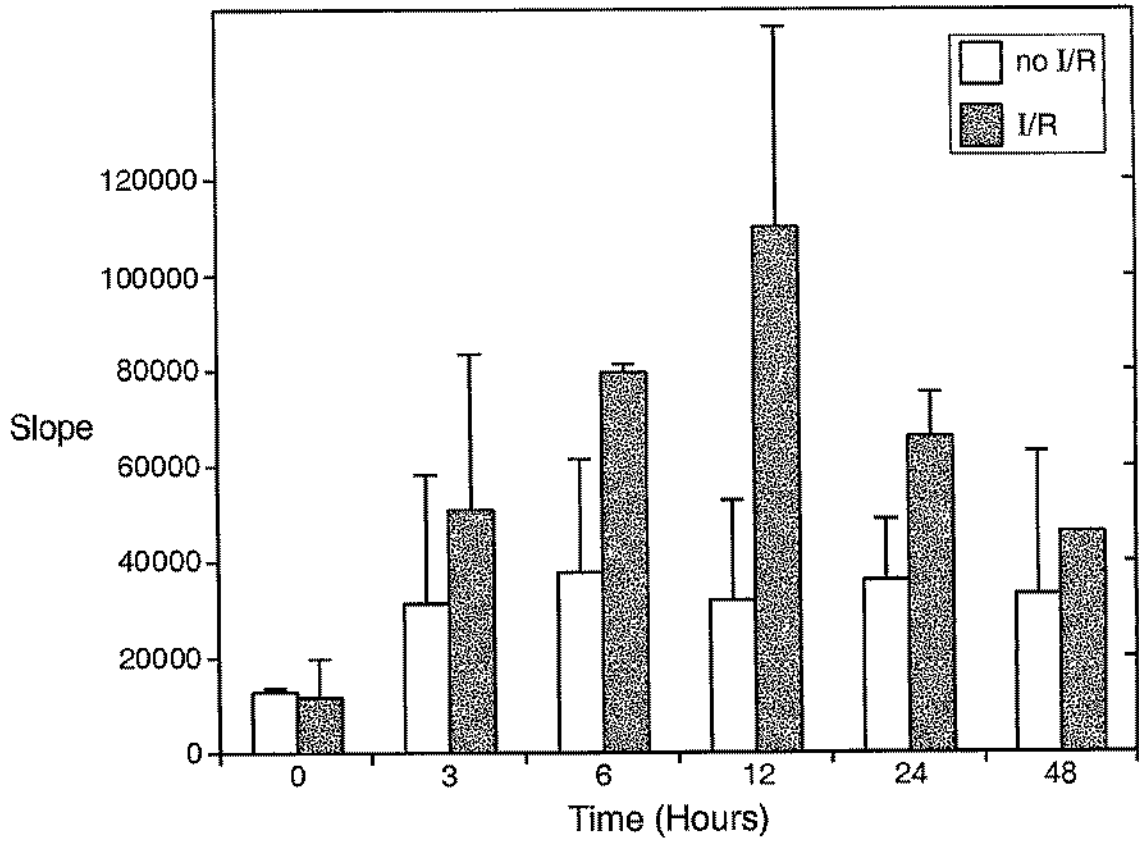
**FIG. 3**



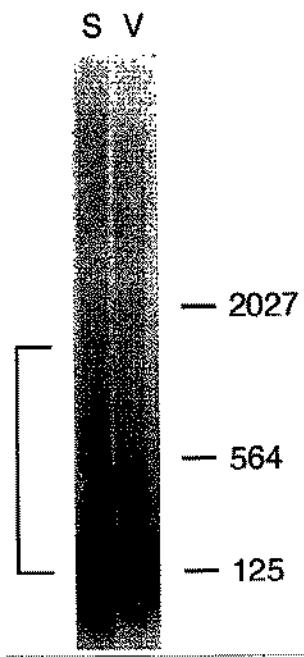
**FIG. 4A**



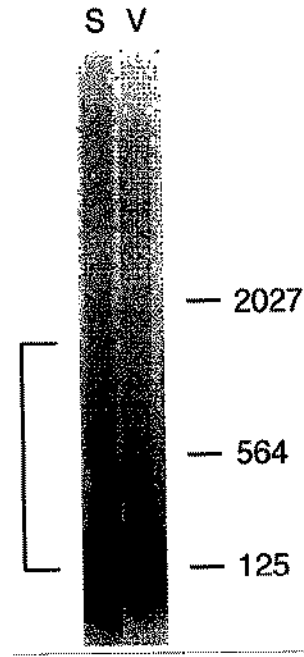
**FIG. 4B**



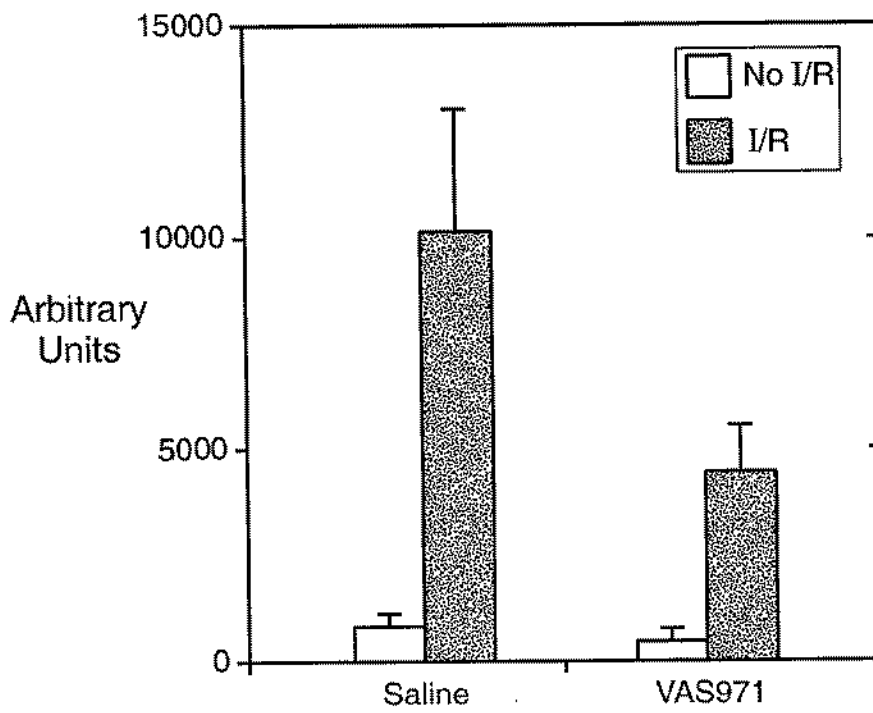
**FIG. 5**



**FIG.\_6A**

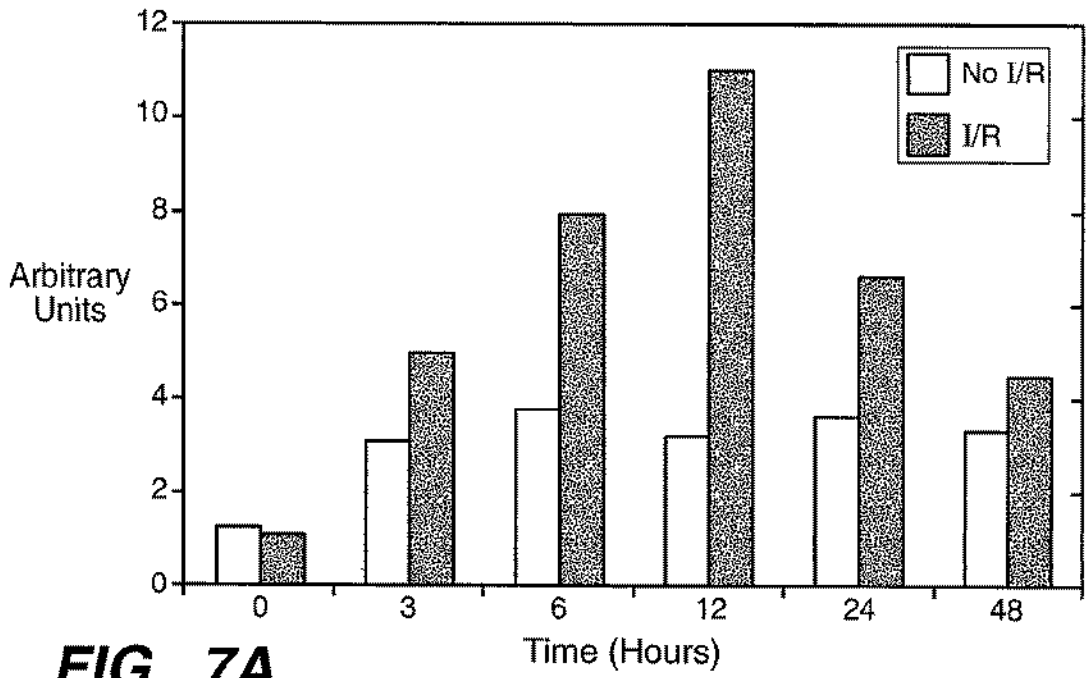


**FIG.\_7B**

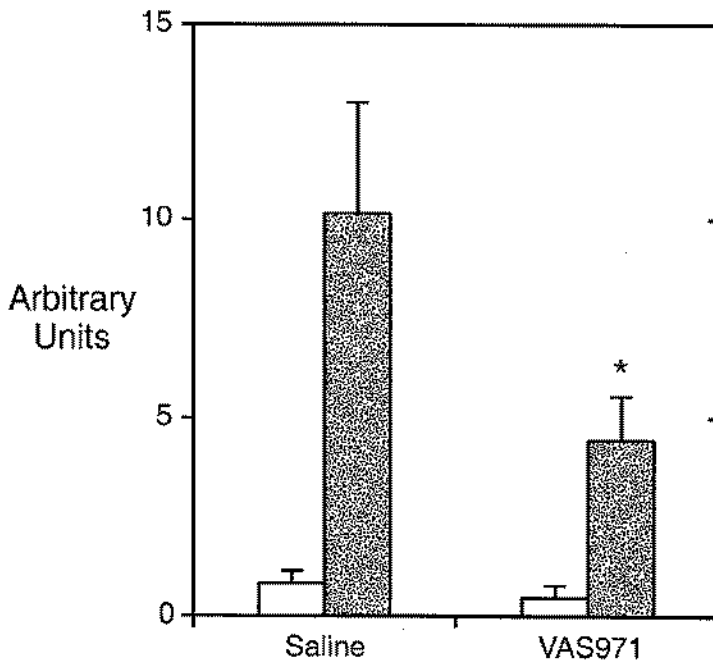


**FIG.\_6B**

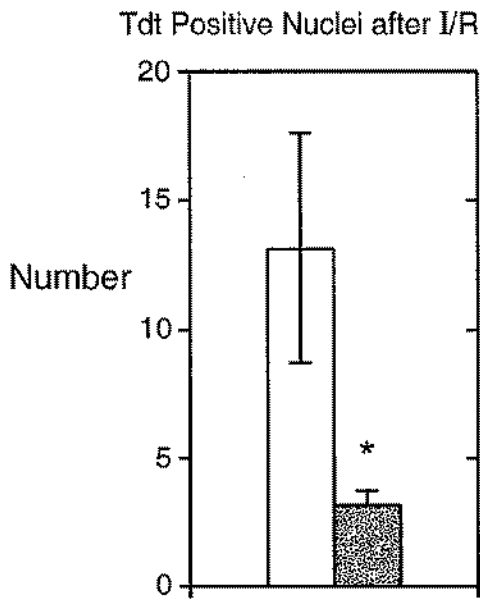




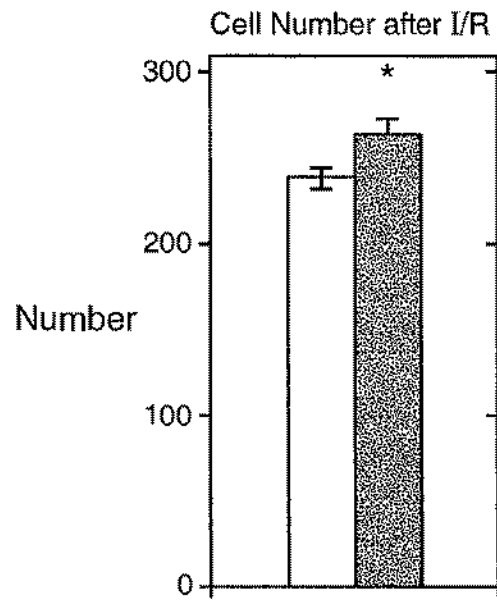
**FIG. 7A**



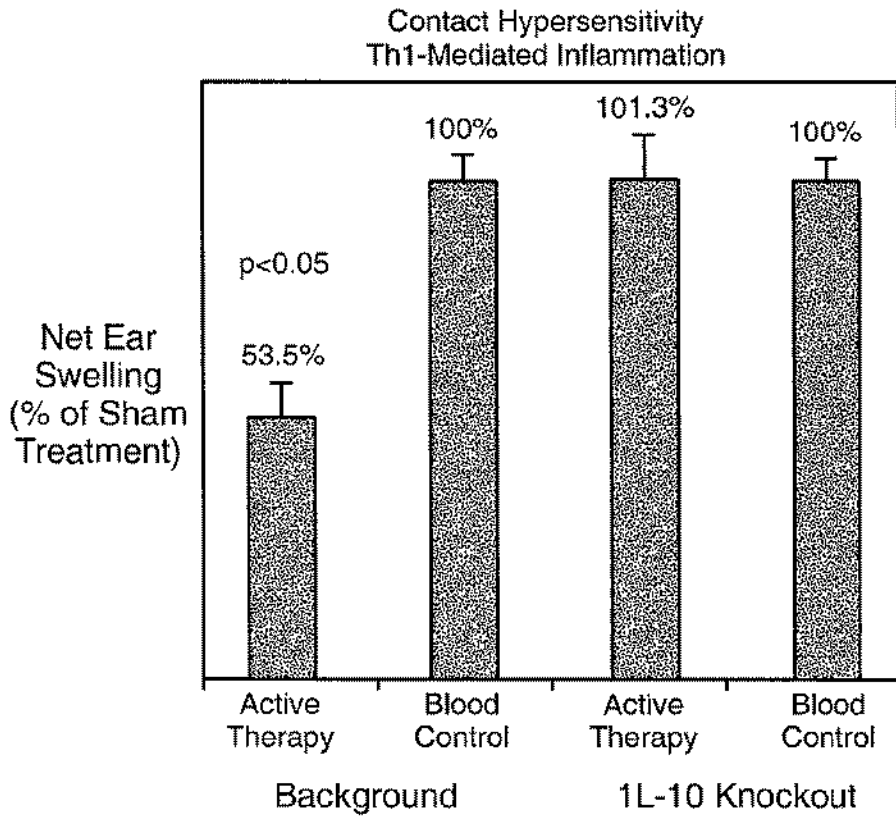
**FIG. 7C**



**FIG.\_8A**



**FIG.\_8B**



**FIG.\_9**

## TREATMENT OF CONGESTIVE HEART FAILURE

### BACKGROUND OF THE INVENTION

#### [0001] 1. Field of the Invention

[0002] This invention relates to methods for treating congestive heart failure, in particular by the administration to a human subject of an aliquot of modified blood, optionally in combination with one or more other treatments for alleviating the symptoms of congestive heart failure.

#### [0003] 2. Description of the Prior Art

[0004] Congestive heart failure (CHF) is a relatively common disorder affecting approximately five million Americans, with a mortality rate of over 80,000 per year. It is believed that CHF is not a distinct disease process in itself, but rather represents the effect of multiple anatomic, functional and biologic abnormalities which interact together to ultimately produce progressive loss of the ability of the heart to fulfill its function as a circulatory pump.

[0005] CHF may be caused by the occurrence of an index event such as a myocardial infarction (heart attack) or be secondary to other causes such as hypertension or cardiac malformations such as valvular disease. The index event or other causes result in an initial decline in the pumping capacity of the heart, for example by damaging the heart muscle. This decline in pumping capacity may not be immediately noticeable, due to the activation of one or more compensatory mechanisms. However, the progression of CHF has been found to be independent of the patient's hemodynamic status. Therefore, the damaging changes caused by the disease are present and ongoing even while the patient remains asymptomatic. In fact, the compensatory mechanisms which maintain normal cardiovascular function during the early phases of CHF may actually contribute to progression of the disease, for example by exerting deleterious effects on the heart and circulation.

[0006] Some of the more important pathophysiologic changes which occur in CHF are activation of the hypothalamic-pituitary-adrenal axis, systemic endothelial dysfunction and myocardial remodeling.

[0007] Therapies specifically directed at counteracting the activation of the hypothalamic-pituitary-adrenal axis include beta-adrenergic blocking agents ( $\beta$ -blockers), angiotensin converting enzyme (ACE) inhibitors, certain calcium channel blockers, nitrates and endothelin-1 blocking agents. Calcium channel blockers and nitrates, while producing clinical improvement have not been clearly shown to prolong survival whereas  $\beta$ -blockers and ACE inhibitors have been shown to significantly prolong life, as have aldosterone antagonists. Experimental studies using endothelin-1 blocking agents have shown a beneficial effect.

[0008] Systemic endothelial dysfunction is a well-recognized feature of CHF and is clearly present by the time signs of left ventricular dysfunction are present. Endothelial dysfunction is important with respect to the intimate relationship of the myocardial microcirculation with cardiac myocytes. The evidence suggests that microvascular dysfunction contributes significantly to myocyte dysfunction and the morphological changes which lead to progressive myocardial failure.

[0009] In terms of underlying pathophysiology, evidence suggests that endothelial dysfunction may be caused by a relative lack of NO which can be attributed to an increase in vascular  $O_2^{\downarrow}$  formation by an NADH-dependent oxidase and subsequent excess scavenging of NO. Potential contributing factors to increased  $O_2^{\uparrow}$  production include increased sympathetic tone, norepinephrine, angiotensin II, endothelin-1 and TNF- $\alpha$ . In addition, levels of IL-10, a key anti-inflammatory cytokine, are inappropriately low in relation to TNF- $\alpha$  levels. It is now believed that elevated levels of TNF- $\alpha$ , with associated proinflammatory cytokines including IL-6, and soluble TNF- $\alpha$  receptors, play a significant role in the evolution of CHF by causing decreased myocardial contractility, biventricular dilatation, and hypotension and are probably involved in endothelial activation and dysfunction. It is also believed that TNF- $\alpha$  may play a role in the hitherto unexplained muscular wasting which occurs in severe CHF patients. Preliminary studies in small numbers of patients with soluble TNF-receptor therapy have indicated improvements in NYHA functional classification and in patient well-being, as measured by quality of life indices.

[0010] Myocardial remodeling is a complex process which accompanies the transition from asymptomatic to symptomatic heart failure, and may be described as a series of adaptive changes within the myocardium. The main components of myocardial remodeling are alterations in myocyte biology, loss of myocytes by necrosis or apoptosis, alterations in the extracellular matrix and alterations in left ventricular chamber geometry. It is unclear whether myocardial remodeling is simply the end-organ response that occurs following years of exposure to the toxic effects of long-term neurohormonal stimulation, or whether myocardial remodeling contributes independently to the progression of heart failure. Evidence to date suggests that appropriate therapy can slow or halt progression of myocardial remodeling.

[0011] Although presently used treatments can alleviate symptoms of CHF and correct certain pathophysiologic abnormalities caused by the disease process, CHF remains a relentlessly progressive condition with a relatively high rate of mortality. In fact, relative reductions in morbidity and mortality brought about by existing drugs are on the order of about 10 to 25 percent. Therefore, the need exists for additive or superior treatments for CHF, especially those which can significantly modify the underlying disease.

### SUMMARY OF THE INVENTION

[0012] The present invention overcomes at least some of the above-noted and other disadvantages of presently known CHF therapies by providing a method for treating CHF in which an aliquot of mammalian blood is treated ex vivo and subsequently introduced into the body of a mammalian subject.

[0013] The aliquot of blood is treated by being subjected to one or more stressors which have been found to modify the blood. According to the present invention, the blood aliquot can be modified by subjecting the blood, or separated cellular or non-cellular fractions of the blood, or mixtures of the separated cells and/or non-cellular fractions of the blood, to stressors selected from temperature stressors, electromagnetic emissions and oxidative environments, or any combination of such stressors, simultaneously or sequentially.

[0014] As discussed above, the pathophysiologic changes associated with CHF include immune activation, endothelial dysfunction and loss of myocytes through necrosis and/or apoptosis. The treatment method of the present invention has been shown to produce therapeutic benefits in each of these three areas.

[0015] With respect to immune activation, the treatment of the present invention has been found to modulate levels of inflammatory cytokines in several Th1/TNF- $\alpha$ -dependent experimental inflammatory models in different species. For example, the treatment has been shown to reduce allergic contact hypersensitivity in Balb/c mice, a Th1-driven immune reaction mediated by TNF- $\alpha$  (Shivji et al., *Journal of Cutaneous Medicine and Surgery* 4: 132-137, 2000); to down-regulate expression of IL-6 mRNA in adjuvant-induced arthritis in the Lewis rat model of inflammatory disease; and to decrease the proportion of Th1 to Th2 cells in patients with scleroderma, a Th1-driven autoimmune disease (Rabinovich et al., Poster presented at the XII Pan-American Congress of Rheumatology, Montreal, Canada, Jun. 21-25, 1998). It is believed that the treatment down-regulates the pro-inflammatory Th1-type immune response, for example by increasing anti-inflammatory Th2-type cytokines, including IL-10.

[0016] The treatment of the invention has been found to improve endothelial function in a number of studies conducted in humans and in animals. For example, the treatment has been found to improve endothelial-dependent vasodilator function in an open study on patients with severe primary Raynaud's disease (Cooke et al., *International Journal of Angiology* 16: 250-254, 1997), to improve the rate of recovery of skin blood flow following temporary occlusion in a double-blind, placebo-controlled study in patients with advanced peripheral vascular disease secondary to atherosclerosis (Courtman et al., *Circulation* Vol 102, #18, suppl II, 2000), to reduce progression of atherosclerosis in the cholesterol-fed LDL receptor deficient mouse (Babaei et al., *Journal of the American College of Cardiology* 35 (Suppl. A): 243, 1999), and to markedly improve endothelial-dependent vasodilator function to acetylcholine in severely atherosclerotic, hypercholesterolemic Watanabe rabbits as evidenced by an increased vasodilatory response to the nitric oxide agonist (acetylcholine) (Courtman et al., above). It is believed that the improvement in endothelial function is due to an anti-inflammatory effect and to increased availability of NO which may result in an improvement in vasodilatory capacity, known to be severely impaired in CHF patients.

[0017] With regard to myocyte loss, the method of the invention is believed to decrease levels of apoptosis and necrosis. It has been shown that the treatment can protect the kidney from ischemia/reperfusion (I/R) damage known to be associated with increased apoptotic cell death (Tremblay et al., *Pathophysiology* 5:26; Chen et al., *Médecine Sciences* 15 (Suppl. 1): 16), and can reduce apoptosis in the kidney following I/R as determined by DNA laddering and density of apoptotic nuclei stained by Tdt.

[0018] Because the treatment of the invention produces therapeutic benefits in three areas in which pathophysiologic changes occur in CHF, namely endothelial dysfunction, production of inflammatory cytokines and myocyte loss due to apoptosis, there is provided a strong theoretical basis on which to predict that the treatment of the invention would be

beneficial to patients with CHF. The method of the invention may be used as a CHF therapy on its own or in combination with other therapies, such as nitrate therapy,  $\beta$ -blockers, ACE inhibitors, AT receptor blocking agents, aldosterone antagonists, calcium channel blocking agents, TNF blocking agents, suppressors of production of TNF- $\alpha$ , and/or other more routine treatment measures such as sodium and fluid restriction, diuretics, digitalis, etc. Specific drugs known to suppress TNF- $\alpha$  production include pentoxifylline, aminone, adenosine, thalidomide, TNF converting enzyme (TACE) inhibitors and dexamethasone. Specific TNF blocking agents include monoclonal antibodies and etanercept.

[0019] Accordingly, in one aspect the present invention provides a method of treating CHF in a human patient suffering therefrom, comprising: (a) treating an aliquot of the patient's blood ex vivo with at least one stressor selected from the group consisting of a temperature above or below body temperature, an electromagnetic emission and an oxidative environment; and (b) administering the aliquot of blood treated in step (a) to the patient, wherein the aliquot has a volume sufficient to alleviate CHF in the patient.

[0020] In another aspect, the present invention provides a combination treatment for CHF in a human patient suffering therefrom, the combination treatment including the administration to the patient of an aliquot of the patient's own blood which has been treated ex vivo with one or more stressors selected from an oxidative environment, thermal stress and electromagnetic emission, and a treatment selected from the group consisting of nitrates,  $\beta$ -blockers, ACE inhibitors, AT receptor blocking agents, aldosterone antagonists, calcium channel blocking agents, TNF blocking agents, suppressors of production of TNF- $\alpha$ , sodium and fluid restriction, diuretics and digitalis.

#### BRIEF DESCRIPTION OF THE DRAWINGS

[0021] The invention is now described, by way of example only, with reference to the accompanying drawings in which:

[0022] FIGS. 1 and 2 of the accompanying drawings are graphical presentations of the results obtained from Example 2 described below;

[0023] FIG. 3 of the accompanying drawings is a graphical presentation of the results obtained from Example 3 described below;

[0024] FIG. 4 of the accompanying drawings is a graphical presentation of the results obtained from Example 4 described below;

[0025] FIGS. 5 to 8 of the accompanying drawings are graphical presentations of the results obtained from Example 5 described below; and

[0026] FIG. 9 of the accompanying drawings is a graphical presentation of the effects of the treatment of the invention in contact hypersensitivity Th1-mediated inflammation

#### DETAILED DESCRIPTION OF PREFERRED EMBODIMENTS

[0027] According to a preferred process of the present invention, an aliquot of blood is extracted from a mammalian subject, preferably a human, and the aliquot of blood is treated ex vivo with certain stressors, described in more

detail below. The terms "aliquot," "aliquot of blood" or similar terms used herein include whole blood, separated cellular fractions of the blood including platelets, separated non-cellular fractions of the blood including plasma, and combinations thereof. The effect of the stressors is to modify the blood, and/or the cellular or non-cellular fractions thereof, contained in the aliquot. The modified aliquot is then re-introduced into the subject's body by any route suitable for vaccination, preferably selected from intrarterial injection, intramuscular injection, intravenous injection, subcutaneous injection, intraperitoneal injection, and oral, nasal or rectal administration.

[0028] The stressors to which the aliquot of blood is subjected *ex vivo* according to the method of the present invention are selected from temperature stress (blood temperature above or below body temperature), an oxidative environment and an electromagnetic emission, individually or in any combination, simultaneously or sequentially. Suitably, in human subjects, the aliquot has a volume sufficient that, when re-introduced into the subject's body, at least partial alleviation of CHF is achieved in the subject. Preferably, the volume of the aliquot is up to about 400 ml, preferably from about 0.1 to about 100 ml, more preferably from about 5 to about 15 ml, even more preferably from about 8 to about 12 ml, and most preferably about 10 ml, along with an anticoagulant, e.g. 2 ml sodium citrate.

[0029] It is preferred, according to the invention, to apply all three of the aforementioned stressors simultaneously to the aliquot under treatment, in order to ensure the appropriate modification to the blood. It may also be preferred in some embodiments of the invention to apply any two of the above stressors, for example to apply temperature stress and oxidative stress, temperature stress and an electromagnetic emission, or an electromagnetic emission and oxidative stress. Care must be taken to utilize an appropriate level of the stressors to thereby effectively modify the blood to alleviate CHF in the subject.

[0030] The temperature stressor warms the aliquot being treated to a temperature above normal body temperature or cools the aliquot below normal body temperature. The temperature is selected so that the temperature stressor does not cause excessive hemolysis in the blood contained in the aliquot and so that, when the treated aliquot is injected into a subject, alleviation of CHF will be achieved. Preferably, the temperature stressor is applied so that the temperature of all or a part of the aliquot is up to about 55° C., and more preferably in the range of from about -5° C. to about 55° C.

[0031] In some preferred embodiments of the invention, the temperature of the aliquot is raised above normal body temperature, such that the mean temperature of the aliquot does not exceed a temperature of about 55° C., more preferably from about 40° C. to about 50° C. even more preferably from about 40° C. to about 44° C., and most preferably about 42.5±1° C.

[0032] In other preferred embodiments, the aliquot is cooled below normal body temperature such that the mean temperature of the aliquot is within the range of from about -5° C. to about 36.5° C., more preferably from about 10° C. to about 30° C., and even more preferably from about 15° C. to about 25° C.

[0033] The oxidative environment stressor can be the application to the aliquot of solid, liquid or gaseous oxidiz-

ing agents. Preferably, it involves exposing the aliquot to a mixture of medical grade oxygen and ozone gas, most preferably by bubbling through the aliquot, at the aforementioned temperature range, a stream of medical grade oxygen gas having ozone as a minor component therein. The ozone content of the gas stream and the flow rate of the gas stream are preferably selected such that the amount of ozone introduced to the blood aliquot, either on its own or in combination with other stressors, does not give rise to excessive levels of cell damage such that the therapy is rendered ineffective. Suitably, the gas stream has an ozone content of up to about 300 µg/ml, preferably up to about 100 µg/ml, more preferably about 30 µg/ml, even more preferably up to about 20 µg/ml, particularly preferably from about 10 µg/ml to about 20 µg/ml, and most preferably about 14.5±1.0 µg/ml. The gas stream is suitably supplied to the aliquot at a rate of up to about 2.0 liters/min, preferably up to about 0.5 liters/min, more preferably up to about 0.4 liters/min, even more preferably up to about 0.33 liters/min, and most preferably about 0.24±0.024 liters/min, at STP. The lower limit of the flow rate of the gas stream is preferably not lower than 0.01 liters/min, more preferably not lower than 0.1 liters/min, and even more preferably not lower than 0.2 liters/min.

[0034] The electromagnetic emission stressor is suitably applied by irradiating the aliquot under treatment from a source of an electromagnetic emission while the aliquot is maintained at the aforementioned temperature and while the oxygen/ozone gaseous mixture is being bubbled through the aliquot. Preferred electromagnetic emissions are selected from photonic radiation, more preferably UV, visible and infrared light, and even more preferably UV light. The most preferred UV sources are UV lamps emitting primarily UV-C band wavelengths, i.e. at wavelengths shorter than about 280 nm. Such lamps may also emit amounts of visible and infrared light. Ultraviolet light corresponding to standard UV-A (wavelengths from about 315 to about 400 nm) and UV-B (wavelengths from about 280 to about 315) sources can also be used. For example, an appropriate dosage of such UV light, applied simultaneously with the aforementioned temperature and oxidative environment stressors, can be obtained from up to eight lamps arranged to surround the sample container holding the aliquot, operated at an intensity to deliver a total UV light energy at the surface of the blood of from about 0.025 to about 10 joules/cm<sup>2</sup>, preferably from about 0.1 to about 3.0 joules/cm<sup>2</sup>, may advantageously be used. Preferably, four such lamps are used.

[0035] The time for which the aliquot is subjected to the stressors is normally within the time range of up to about 60 minutes. The time depends to some extent upon the chosen intensity of the electromagnetic emission, the temperature, the concentration of the oxidizing agent and the rate at which it is supplied to the aliquot. Some experimentation to establish optimum times may be necessary on the part of the operator, once the other stressor levels have been set. Under most stressor conditions, preferred times will be in the approximate range of from about 2 to about 5 minutes, more preferably about 3 or about 3½ minutes. The starting blood temperature, and the rate at which it can be warmed or cooled to a predetermined temperature, tends to vary from subject to subject. Such a treatment provides a modified blood aliquot which is ready for injection into the subject.

[0036] In the practice of the preferred process of the present invention, the blood aliquot may be treated with the stressors using an apparatus of the type described in U.S. Pat. No. 4,968,483 to Mueller. The aliquot is placed in a suitable, sterile, UV light-transmissive container, which is fitted into the machine. The UV lamps are switched on for a fixed period before the gas flow is applied to the aliquot providing the oxidative stress, to allow the output of the UV lamps to stabilize. The UV lamps are typically on while the temperature of the aliquot is adjusted to the predetermined value, e.g.  $42.5 \pm 1^\circ \text{C}$ . Then the oxygen/ozone gas mixture, of known composition and controlled flow rate, is applied to the aliquot, for the predetermined duration of up to about 60 minutes, preferably 2 to 5 minutes and most preferably about 3 minutes as discussed above, so that the aliquot experiences all three stressors simultaneously. In this way, blood is appropriately modified according to the present invention to achieve the desired effects.

[0037] A subject preferably undergoes a course of treatments, each individual treatment comprising removal of a blood aliquot, treatment thereof as described above and re-administration of the treated aliquot to the subject. A course of such treatments may comprise daily administration of treated blood aliquots for a number of consecutive days, or may comprise a first course of daily treatments for a designated period of time, followed by an interval and then one or more additional courses of daily treatments.

[0038] In one preferred embodiment, the subject is given an initial course of treatments comprising the administration of 4 to 6 aliquots of treated blood. In another preferred embodiment, the subject is given an initial course of therapy comprising administration of from 2 to 4 aliquots of treated blood, with the administration of any pair of consecutive aliquots being either on consecutive days, or being separated by a rest period of from 1 to 21 days on which no aliquots are administered to the patient, the rest period separating one selected pair of consecutive aliquots being from about 3 to 15 days. In a more specific, preferred embodiment, the dosage regimen of the initial course of treatments comprises a total of three aliquot, with the first and second aliquots being administered on consecutive days and a rest period of 11 days being provided between the administration of the second and third aliquots. In the method of the invention, it is preferred that no more than one aliquot is administered to the subject on any given day.

[0039] It may be preferred to subsequently administer additional courses of treatments following the initial course of treatments. Preferably, subsequent courses of treatments are administered at least about three weeks after the end of the initial course of treatments. In one particularly preferred embodiment, the subject receives a second course of treatments comprising the administration of one aliquot of treated blood every 30 days following the end of the initial course of treatments, for a period of 6 months.

[0040] It will be appreciated that the spacing between successive courses of treatments should be such that the positive effects of the treatment of the invention are maintained, and may be determined on the basis of the observed response of individual subjects.

[0041] As discussed above, the method of the present invention may preferably be used as an adjunctive treatment in combination with other therapies for CHF. Preferred

examples of such other therapies include one or more of AGE inhibitors,  $\alpha$ -blockers, aldosterone antagonists, TNF blockers, suppressors of TNF production and other forms of routine therapy.

[0042] The invention is further illustrated and described with reference to the following specific examples.

#### EXAMPLE 1

[0043] This example describes a study conducted to determine the effect of the treatment of the invention on endothelial function in Watanabe rabbits, known to develop complex atherosclerotic lesions during the first year of life. As previously mentioned, endothelial dysfunction is linked to the pathophysiology of CHF.

[0044] The rabbits entered the study at 7 to 8 months of age, and were randomized into three groups, a first group to be sacrificed immediately for baseline measurements, a second group ( $n=10$ ) which received injections of blood treated according to the invention, and a third group ( $n=10$ ) which received sham treatments comprising injections of untreated blood.

[0045] The treatment comprised a total of 4 injections of treated blood over a period of 10 weeks. The blood was treated by exposure to the following three stressors in an apparatus as generally described in U.S. Pat. No. 4,968,483 to Mueller et al.:

[0046] (a) an elevated temperature of  $42.5^\circ \text{C} \pm 1.0^\circ \text{C}$ ;

[0047] (b) a gas mixture of medical grade oxygen containing  $14.5 \pm 1.0 \mu\text{g/ml}$  of ozone, bubbled through the blood at a flow rate of  $240 \pm 24 \text{ ml/min}$  for 3 minutes; and

[0048] (c) ultraviolet light at a wavelength of 253.7 nm, and a total energy density of  $2.0 \text{ joules/cm}^2$  (with some fluctuation within the previously mentioned range).

[0049] The treated blood was administered to the animals by intra-muscular injection. The control animals were administered intra-muscular injections of untreated blood on the same injection schedule as the treated animals.

[0050] All animals were sacrificed at 11 months of age. Ring preparations were taken from the iliac arteries of the animals and were evaluated for the amount of relaxation induced by acetylcholine (an endothelial-dependent vasodilator) after being treated with phenylephrine (a vasoconstrictor).

[0051] Evaluation of the ring preparations showed a significant increase in endothelial-mediated vasorelaxation ( $52.2 \pm 6\%$ ) was observed in the treated animals as compared to the control animals injected with untreated blood ( $22.9 \pm 4\%$ ,  $p$  less than 0.001).

[0052] No relaxation was observed when the endothelium was removed from the ring preparations, further confirming the endothelium-specific effect of the treatment of the invention.

#### EXAMPLE 2

[0053] This example describes a study into the effects of the treatment of the invention therapy on patients suffering

from peripheral vascular disease (PVD). The study was conducted at the University Hospital, Lund, Sweden.

[0054] The study comprised a placebo-controlled, double blind study in 18 patients (7 males, 11 females) with moderately advanced PVD, whose main symptom was intermittent claudication. The patients participating in the study were recruited from the attending population of the Department of Internal Medicine of the University Hospital, Lund, Sweden.

[0055] The patients were randomly assigned to receive either placebo (intramuscular injection of 10 ml warm saline) or treatment according to the invention comprising intramuscular injections of 10 ml of treated autologous blood. The treatment of the blood involved the collection of a 10 ml aliquot of a patient's venous blood into 2 ml of sodium citrate 3-4% as anticoagulant. Each blood aliquot was transferred to a sterile, disposable low-density polyethylene vessel and then exposed to the following conditions in an apparatus as generally described in U.S. Pat. No. 4,968, 483 to Mueller et al.:

[0056] (d) elevated temperature of  $42.5^{\circ}\text{C} \pm 1.0^{\circ}\text{C}$ ;

[0057] (e) medical oxygen containing  $14.5 \pm 1.0 \mu\text{g/ml}$  of ozone bubbled through the blood aliquot at a flow rate of  $240 \pm 24 \text{ ml/min}$  at STP for 3 minutes; and

[0058] (f) ultra-violet light at a wavelength of 253.7 nm, and a total energy of about  $2.0 \text{ joules/cm}^2$ .

[0059] Each patient received a total of 12 injections of saline or treated blood over a period of 9 weeks.

[0060] The therapy was assessed by measuring the recovery rate of skin blood flow and oxygen tension following total temporary occlusion of blood flow in the extremities of each patient prior to commencement of the therapy and at 3 weeks, 6 weeks, 9 weeks and 2 months following the initiation of the therapy.

[0061] Skin blood flow in the foot was measured by Laser Doppler Fluximetry (LDF) and oxygen tension was determined by measurement of transcutaneous skin oxygen pressure ( $\text{TcpO}_2$ ) in the foot. In patients receiving the treatment of the invention, a strong trend was observed toward a treatment-related reduction in both the total time to reach maximum perfusion ( $\text{IP}_{\text{M}}$ ) and the half-time to reach maximum perfusion ( $\text{T}_{1/2}\text{P}_{\text{M}}$ ), indicative of an improvement in the rate of recovery of skin blood flow. No change was observed in the control group.

[0062] The improved rate of recovery of blood flow in patients treated according to the invention was apparent during the course of treatments and persistent throughout, but did not reach significance until 2 months following initiation of the therapy. A comparison of the  $\text{T}_{1/2}\text{P}_{\text{M}}$  for the placebo and treated groups, as measured by LDF, is shown in FIG. 1.

[0063] There was also an observed trend toward more rapid recovery of skin oxygen content in the treated group. This difference became statistically significant at 2 months following the initiation of the therapy. A comparison of the half-time to maximum  $\text{TcpO}_2$  after ischemia ( $\text{O}_2\text{T}_{1/2}$ ) for the treated group compared to the placebo group is shown in FIG. 2.

[0064] The study therefore demonstrated that, in this group of moderately advanced PVD patients, the treatment of the invention had a clear biological effect on the rate at which blood flow in the skin of the foot was recovered following a period of total occlusion ischemia. A similar effect, but of smaller magnitude, was noted for the rate of  $\text{TcpO}_2$  recovery, whereas patients receiving placebo treatment showed no change. These results suggest that the treatment of the invention has a beneficial effect on endothelial function, and appears to improve skin microcirculatory function in patients with PVD.

### EXAMPLE 3

[0065] This example relates to the use of the treatment of the invention to prevent the onset of arthritis, and describes the results of a study conducted in an established animal model of arthritis. The specific animal model used in this study was adjuvant-induced arthritis in rats (see, for example, Pearson, C., 1956, "Development of Arthritis, peri-arthritis and periostitis in rats given adjuvant", *Proc. Soc. Exp. Biol. Med.*, 91:95). According to this model, arthritis is induced in rats by injecting them with adjuvant containing *Mycobacterium butyricum*.

[0066] Male Lewis rats, 4 to 5 weeks of age, 100 to 120 g, were obtained from Charles River Laboratories, quarantined one week and entered into the study. An adjuvant mature was prepared for induction of arthritis by suspending 50 mg *M. butyricum* (Difco Laboratories, Inc., Detroit, Mich.) in 5 ml light white paraffin oil—m3516 (Sigma Chemical Co., St. Louis, Mo.) and thoroughly mixed using a homogenizer. Aliquots of the mixture sufficient to supply 0.15 mg *M. butyricum* was injected into each animal subcutaneously, at the base of the tail. Symptoms of arthritis appeared about 12 days after induction, in each animal, as evidenced by limb swelling.

[0067] Two rats, which were not injected with the adjuvant mixture, were used as blood donors. Blood was collected from the donors by cardiac puncture, and 10 ml of citrated blood was transferred to a sterile, low density polyethylene vessel for ex vivo treatment with stressors according to the invention. Using an apparatus as generally described in the above-mentioned Mueller patent, the blood was stressed by a treatment according to the invention.

[0068] Six animals were given a course of 2 injections of 0.2 ml aliquots of the treated blood, the injections being administered on consecutive days after the onset of arthritis. A control group of 8 rats received injections of untreated blood using the same injection schedule as the treated animals. Injections commenced one day after the induction of arthritis. Hind paw volumes of the animals were measured, on alternate days, after onset of arthritis, by water displacement in a 250 ml beaker using a top-loaded Mettler balance. The results for each group of animals were averaged and are presented graphically on the accompanying FIG. 3, a plot of mean foot volume against days after induction of arthritis. The upper curve is derived from the control group of animals, the lower curve from the animals which received the course of injections of treated blood. A significant decrease in the severity of the arthritis, as indicated by lower foot volumes, is apparent for the treated animals as compared to the animals of the control group.

[0069] The above results show that treatment of subjects with modified mammalian blood can effectively prevent the onset of arthritis in mammals.

[0070] The expression of IL-6 mRNA in lymph nodes of treated and untreated animals was measured 10 days after induction of arthritis, and the results are presented below in Table I.

TABLE I

Treatment	IL-6 copy no. (per 4500 actin units)
Active	<35 (n = 8)
Control	254 ± 203 (n = 8)

[0071] The results shown above in Table I show that the treatment according to the invention can modulate levels of inflammatory cytokines in a Th1/TNF- $\alpha$ -dependent model of arthritis. There is evidence that production of inflammatory cytokines such as IL-6 and TNF- $\alpha$  is linked to the pathophysiology of CHF.

## EXAMPLE 4

[0072] The experiment reported in this example demonstrates, by use of an animal model system involving ischemia and subsequent reperfusion of various body organs, that the treatment of the present invention has the effect of reducing apoptosis and necrosis. Ischemia-reperfusion injuries are known to involve increase of apoptosis and necrosis in the affected organs and tissues—see for example Saikumar p, et. al. “Mechanisms of cell death in hypoxia/reoxygenation injury”, *Oncogene* 1998 December 24; 17(25):3341-9; and Burns A. T. et.al., “Apoptosis in ischemia/reperfusion injury of human renal allografts”, *Transplantation*, 1998 October 15; 66(7): 872-6, and other publications both preceding and following those. Known techniques of determination of apoptosis at the cellular level are employed in this example.

[0073] Pure-bred normal beagle dogs, aged 1-2 years, equal numbers of males and females, were used as the experimental animals. The animals were separated into four groups, A, B, C and D, each group consisting of six animals, three males and three females. Animals of groups A and C were subjected to the process of the invention, by being subjected to two 10-day courses of daily removal of an 8 ml aliquot of blood, extracorporeal treatment of the aliquot with oxygen/ozone, UV radiation and heat, and re-administration of 5 ml of the treated aliquot to the same animal, by intramuscular injection.

[0074] Each such treatment was conducted as follows.

[0075] An 8-ml aliquot of blood was extracted from the animal, treated with sodium citrate (2 ml) and placed in a sterile container. It was subjected simultaneously to the UV radiation, oxygen/ozone gas oxidative environment and elevated temperature stressors, in an apparatus as generally described in the aforementioned Mueller U.S. Pat. No. 4,969,483. More specifically, the blood sample in the sterile, UV-transparent container was heated using infra-red lamps to 42.5° C., and whilst being maintained at that temperature, it was subjected to UV radiation of predominant wavelength 253.7 nm under the preferred conditions previously described. Simultaneously, a mixture of medical grade oxygen and ozone, of ozone content 13.5-15.5  $\mu\text{g}/\text{ml}$  was

bubbled through the blood sample at a flow rate within the range from 60-240 mls/min (STP). The time of simultaneous UV exposure and gas mixture feed was 3 minutes. A 5 ml portion of the treated blood aliquot was reinjected intramuscularly into each test animal.

[0076] Each animal of groups A and C, receiving the courses of treatment according to the invention, experienced a three week rest period between the 10-day courses of treatment. Groups B and D were the control groups, given two 10-day courses of daily injections of 5 ml of physiological saline, with a three-week rest period between the 10-day courses.

[0077] One day following the second course of injections, the animals were anaesthetized under light gas anaesthesia, and the right kidney of each animal was removed through a back incision. An occlusive clip was placed on the remaining renal artery and vein, to expose the left kidney to transient ischemia, for 60 minutes. Then the clip was removed to allow reperfusion of the kidney by normal blood flow.

[0078] The animals were observed for 6 days after the ischemia procedure, and then sacrificed. The ischemic kidney of each animal was surgically removed and divided into two parts. One part was kept frozen at -80° C., and the other part was fixed in 10% formalin for immuno- and routine histopathology studies.

[0079] Mitochondrial membrane potential was measured in proximal tubular cells isolated from the ischemic and control kidneys, both at the time of removal of the control kidney and following sacrifice. For this purpose, dog kidney proximal tubes were purified from normal or ischemic kidney cortexes by the collagenase treatment procedure described by Marshansky et al., “Isolation of heavy endosomes from dog proximal tubes in suspension”, *J. Membr. Biol.* 153(1), 59-73, 1996. Renal mitochondria were isolated in suspension by differential centrifugation (see Marshansky, “Organic hydroperoxides at high concentrations cause energization and activation of AATP synthesis in mitochondria”, *J. Biol. Chem.* 264(7), 3670-3673, 1989, after tissue homogenization in a buffer containing 250 mM sucrose, 10 mM HEPES-Tris (pH 7.5), and 250  $\mu\text{M}$  EDTA. Cell debris was removed by centrifugation at 10,000 g for 30 minutes. The mitochondria were washed with the sucrose/HEPES buffer without EDTA.

[0080] Mitochondrial membrane potential was measured as described by Kroemer, G., Zamzam, N. and Susin, S. A., “Mitochondrial control of apoptosis”, (Review) *Immunology Today* (1997) v.18, p 44-51; with JC-1 dye—see Salvioli et.al., “JC-1, but not DiOC6(3) or rhodamine 123, is a reliable fluorescent probe to assess delta psi changes in intact cells: implications for studies on mitochondrial functionality during apoptosis”, *FEBS Letters* 411 (1), 77-82, 1987. JC-1 fluorescence in the suspension of purified mitochondria from normal and ischemic kidneys was monitored continuously on a Deltascan Model RFM-2001 spectrofluorimeter (Photon Technology International, South Brunswick, N.J.). The excitation wavelength was 490 nm (slit width 2 nm) and the emission wavelength was 590 nm (slit width 4 nm). The signals were recorded using Felix® (Version 1.1) software. All measurements were performed with continuous stirring at 37° C. The incubation buffer for measurement of mitochondrial membrane potential contained 200 mM sucrose, 5 mM  $\text{MgCl}_2$ , 5 mM  $\text{KH}_2\text{PO}_4$ , 0.1



$\mu\text{M}$  of JC-1 and 30 mM HEPES-Tris (pH 7.5). The concentrations of the substrate and inhibitors were 10 mM succinate, 0.1  $\mu\text{M}$  rotenone with or without 0.1  $\mu\text{M}$  FCCP. Proximal tubule mitochondrial membrane potential was estimated in the right (control) kidney prior to ischemia and in the left (ischemic) kidney after sacrifice of the dogs on day 6 following ischemia and was estimated as difference of JC-1 fluorescence after uncoupling of mitochondria with FCCP as shown in the accompanying FIG. 4A. For each measurement, 50  $\mu\text{g}$  protein of purified material was used.

[0081] JC-1 fluorescence is proportional to the mitochondrial membrane potential. The contralateral nephrectomized kidney served as control. As is clear from the FIG. 4B, the treatment process of the invention did not modify the membrane potential of the non-ischemic control right kidney ( $p=0.445$  for treated vs saline). However, the ischemic kidney of the saline-injected animals showed significantly lower ( $p<0.05$ ) fluorescence compared to the control kidney. The stress treatment according to the invention prevented the uncoupling of mitochondria during ischemic/reperfusion, and membrane potential showed no significant difference ( $p=0.244$ ) between ischemic and control kidneys. This parameter remained significantly higher ( $p=0.0006$ ) vs saline-injected dogs) in the ischemic kidneys of dogs pre-treated according to the process of the invention for at least 6 days post-reperfusion.

[0082] These results indicate that the process of the invention effects protection of the kidney against apoptosis and/or accelerates recovery at the mitochondrial level. Accordingly the process of the invention is indicated for pre-conditioning of the cells, tissues and organs of a mammalian body against subsequently encountered factors which will normally accelerate apoptosis.

[0083] Specifically, the preservation of mitochondrial membrane potential evidences the capacity of the therapy to protect mitochondria, and thereby to precondition cells against apoptosis.

#### EXAMPLE 6

[0084] A group of 12 male SHR rats was treated with either injections of pooled blood stressed as described in Example 4 above, or, in control animals, with injections of saline. Since the blood from all of the animals of this genetic strain is identical, blood from one animal of this same strain was treated by the process of the invention for administration to the test animal. The blood was treated with sodium citrate as anti-coagulant, and placed in a sterile container. They received either injections of 150  $\mu\text{l}$  of stressed blood on days -14 and -13 followed by a rest period of 11 days and a third injection the day before ischemic surgery, or injections in parallel with saline. On the day of surgery, the rats were anaesthetized with light flurane, and the right kidney was removed through a mid-abdominal incision. The left kidney was then subjected to transient ischemia by occlusion of the left renal artery and vein using a microclip. The skin was then temporarily closed. After 60 minutes of occlusion, the clip was removed and the wound was closed with a suture. The animals were sacrificed 12 hours after reperfusion.

[0085] The ischemic and non-ischemic kidneys of the test animals were removed and subjected to DNA laddering tests. Oligonucleosomal DNA fragmentation into 180 to 200

base pairs is a specific pattern which appears as a ladder after agarose gel electrophoresis in various organs undergoing apoptosis. To estimate the degree of DNA fragmentation in the kidney cortex, an aliquot of pulverized kidney cortex was weighed and total tissue DNA was extracted by the phenol-chloroform procedure after tissue digestion with proteinase K and RnaseA in the presence of EDTA. One  $\mu\text{g}$  of extracted DNA was labeled by enzymatic assay using terminal deoxynucleotidyl transferase with  $\text{P}^{32}$ -dCTP (see Teiger et.al., 'Apoptosis in pressure overload-induced heart hypertrophy in the rat', J. Clin. Invest. 97, 2891-2897, 1996). Increasing quantities of radio-labelled DNA were loaded onto 1.5% agarose gels. After electrophoresis, DNA was transferred onto nylon membranes (Hybond) and the radioactivity associated with 150 to 1500 bp DNA fragments was quantified in a PhosphorImager (Molecular Dynamics). A regression line for each sample was drawn for the radioactivity as a function of DNA loaded on the gel (see deBlois et.al., 'Smooth muscle cell apoptosis during vascular regression in spontaneously hypertensive rats.' Hypertension 29, 340-349, 1997). The slope of the linear regression line served as a DNA fragmentation index (cpm/pixel per  $\mu\text{g}$  DNA).

[0086] The results from ischemic-reperfused (I/R) kidneys and from normal, non-I/R kidneys, all from animals which did not receive injections of stressed blood, are shown graphically on FIG. 5, a plot of the slope of the regression lines for the various samples (vertical axis) against time after initiation of reperfusion. The DNA laddering, indicative of DNA fragmentation, was clearly increased in the ischemic kidney cortex compared to the contralateral non-ischemic organ and the maximal attained at twelve hours returned to near basal values by 48 hours. Twelve hours was thus selected as the time point for study of the effect of the stressed blood of the invention on early ischemia-induced renal apoptosis.

[0087] FIG. 6A of the accompanying drawings is a picture of the electrophoresis gel of the fragmented DNA, in the 150-1500 bp range, radio-labeled as described to attach radioactivity labels to the DNA fragments. Trace S derives from DNA of kidneys from animals which received saline injections prior to kidney ischemia-reperfusion, and trace V derives from DNA of kidneys of animals which received injections of the stressed blood prior to kidney ischemia-reperfusion. The Figure shows that 60 minutes renal ischemia induced a clear accumulation of fragmented DNA in both groups of rats at 12 h but the level of this parameter was significantly lower ( $p<0.05$ ) in animals receiving the treated blood. FIG. 6B quantifies the amount of irradiation from the samples, in arbitrary units, and shows that DNA fragmentation-laddering occurs in both S and V samples as a result of ischemia/reperfusion, but that the extent is markedly reduced in V samples as compared with S samples. The results presented on FIG. 6B are the means of six animals in each case.

[0088] These results confirm that the cytoprotective effect of the administration of stressed blood according to the invention on renal reperfusion injury involves the inhibition of early or late apoptosis.

[0089] The ability of the treatment of the invention in reducing apoptosis in the kidney following ischemia/reperfusion during the early phase of apoptosis (after 12 hours) as

determined by DNA laddering and density of apoptotic nuclei stained by Tdt is shown in FIGS. 7 and 8, respectively. As well, FIG. 3B shows that cell numbers in the kidney following ischemia/reperfusion were also significantly higher in the animals treated according to the invention.

#### EXAMPLE 6

[0090] This example describes the treatment of a small number of human patients with advanced chronic congestive heart failure. The patients had NYHA class III-IV chronic congestive heart failure, with a left ventricular ejection fraction (LVEF) of less than 40% and a 6 minute walk distance of less than 300 m. Some of the patients had previously received other CHF treatments.

[0091] Protocol:

[0092] Patients receive a number of injections of treated blood. The treatment schedule comprises injections on days 1, 2 and 14, followed by a single injection every 30 days for 5 months, each injection having a volume of 10 ml. Each individual treatment comprises the following steps:

[0093] 1. Collection of 10 ml of a patient's own venous blood into 2 ml of 3-4% sodium citrate for injection, USP. The sodium citrate is added to the sample to prevent the blood from coagulating during the treatment.

[0094] 2. Transfer of the citrated blood sample to a sterile, disposable, low-density polyethylene vessel.

[0095] 3. Ex vivo treatment of the blood sample by simultaneous exposure to:

[0096] an elevated temperature of  $42.5 \pm 1.0^\circ \text{C}$ .,

[0097] a gas mixture of medical grade oxygen containing  $14.5 \pm 1.0 \mu\text{g/ml}$  of ozone which is bubbled through the blood sample at a flow rate of  $240 \pm 24 \text{ ml/min}$  (at STP); and

[0098] ultraviolet light at a wavelength of 253.7 nm.

[0099] 4. Transfer of the blood sample from the sterile disposable container to a sterile syringe.

[0100] 5. Intramuscular injection of 2 ml or 10 ml of the treated blood sample into the gluteal muscle of the same patient, following a local anaesthetic (1 mL of 2% Novocain or equivalent) at the injection site.

[0101] The ex vivo treatment of the blood sample described in step (3) above is performed with an apparatus as generally described in U.S. Pat. No. 4,968,483 to Mueller et al. The blood sample is simultaneously exposed to all three stressors for a period of 3 minutes.

[0102] Assessment of CHF:

[0103] Patients are monitored for adverse events during each visit. As well, a post-treatment follow-up is conducted to monitor survival, hospitalizations, and significant adverse events.

[0104] The primary endpoints used to assess the effectiveness of the treatment are changes in 6-minute walking distance and/or NYHA functional classification. Secondary endpoints include: Improvement in cardiac function, reduc-

tion in diuretic requirement; reduction in hospitalization stay; and improvement in symptoms.

[0105] As demonstrated by the data described above, the treatment of the present invention has been shown to have significant biological activity in humans and in a number of animal model systems, all of which involve Th1/TNF- $\alpha$  dependent inflammatory responses. As mentioned above, it is believed that the treatment down-regulates the pro-inflammatory Th1-type immune response, for example by increasing anti-inflammatory Th2 type cytokines, including IL-10. This would at least partially explain the ability of the treatment of the invention to produce therapeutic benefits in each of the three areas which characterize CHF.

[0106] Furthermore, there is evidence to suggest that the treatment of the invention is IL-10 dependent (FIG. 9 and Shahid S. et al., *Journal of Investigative Dermatology*, 14, No.4, 2000), bringing about an up-regulation of anti-inflammatory cytokines such as IL-10, and a down-regulation of Th1 driven immune responses. It has also been proposed that IL-10 may be an important component of the cytokine network in CHF, as there appears to be a reduction in the level of IL-10 in relation to TNF- $\alpha$  in CHF (Yamaoka et al., *Jpn Circ J* 63: 951-956).

[0107] Although the invention has been described with reference to specific preferred embodiments, it will be appreciated that many variations may be made to the invention without departing from the spirit or scope thereof. All such modifications are intended to be included within the scope of the following claims.

What is claimed is:

1. A method of treating congestive heart failure (CHF) in a human patient suffering therefrom, comprising:

(a) treating an aliquot of the patient's blood ex vivo with at least one stressor selected from the group consisting of a temperature above or below body temperature, an electromagnetic emission and an oxidative environment; and

(b) administering the aliquot of blood treated in step (a) to the patient, wherein the aliquot has a volume sufficient to alleviate CHF in the patient.

2. The method of claim 1, wherein the oxidative environment comprises applying an oxidizing agent to the aliquot.

3. The method of claim 2, wherein the oxidizing agent contains ozone gas, and the ozone gas is introduced into the blood aliquot in an amount which does not give rise to excessive levels of cell damage.

4. The method of claim 2, wherein the oxidizing agent comprises a mixture of ozone gas and medical grade oxygen, the ozone gas being contained in the mixture in a concentration of up to about  $300 \mu\text{g/ml}$ .

5. The method of claim 4, wherein the ozone gas is contained in the mixture in a concentration of up to about  $30 \mu\text{g/ml}$ .

6. The method of claim 5, wherein the ozone gas is contained in the mixture in a concentration of from about  $13.5 \mu\text{g/ml}$  to about  $15.5 \mu\text{g/ml}$ .

7. The method of claim 4, wherein the mixture is applied to the aliquot at a flow rate of up to about 0.33 liters/min.

8. The method of claim 7, wherein the mixture is applied to the aliquot at a flow rate of from about 0.21 liters/min to about 0.27 liters/min.

9. The method of claim 1, wherein the electromagnetic emission comprises ultraviolet light having one or more UV-C band wavelengths.

10. The method of claim 1, wherein the temperature to which the aliquot is cooled or heated is a temperature which does not result in substantial hemolysis of the blood in the aliquot.

11. The method of claim 1, wherein the temperature stressor is applied so that the temperature of at least part of the aliquot is in the range of from about  $-5^{\circ}$  C. to about  $55^{\circ}$  C.

12. The method of claim 1, wherein the mean temperature of the blood in the aliquot is in the range of from about  $37^{\circ}$  C. to about  $44^{\circ}$  C.

13. The method of claim 1, wherein the mean temperature of the blood in the aliquot is in the range of from about  $0^{\circ}$  C. to about  $36.5^{\circ}$  C.

14. The method of claim 1, wherein the mean temperature of the blood in the aliquot is in the range of from about  $10^{\circ}$  C. to about  $30^{\circ}$  C.

15. The method of claim 1, wherein the temperature is in the range of from about  $37^{\circ}$  C. to about  $55^{\circ}$  C.

16. The method of claim 15, wherein the temperature is  $42.5 \pm 1^{\circ}$  C.

17. The method of claim 1, wherein the volume of the aliquot is up to about 400 ml.

18. The method of claim 17, wherein the volume of the aliquot is about 10 ml.

19. The method of claim 17, wherein the volume of the aliquot is about 2 ml.

20. The method of claim 1, wherein the aliquot is subjected to the stressors for a period of up to about 60 minutes.

21. The method of claim 20, wherein the aliquot is subjected to the stressors for a period of about 3 minutes.

22. The method of claim 1, wherein the blood is administered to the mammal by a method suitable for vaccination selected from the group consisting of intra-arterial injection, intramuscular injection, intravenous injection, subcutaneous injection, intraperitoneal injection, and oral, nasal or rectal administration.

23. The method of claim 1, wherein all of the stressors are simultaneously administered to the aliquot.

24. The method of claim 1, wherein any two of the stressors are simultaneously administered to the aliquot.

25. A combination treatment for congestive heart failure (CHF) in a human patient suffering therefrom, the combination treatment including the administration to the patient of an aliquot of the patient's own blood which has treated ex vivo with one or more stressors selected from an oxidative environment, thermal stress and electromagnetic emission, and a treatment selected from the group consisting of nitrates,  $\beta$ -blockers, ACE inhibitors, AT receptor blocking agents, aldosterone antagonists, calcium channel blocking agents, TNF blocking agents, suppressors of production of TNF- $\alpha$ , sodium and fluid restriction, diuretics and digitalis.

26. The combination treatment of claim 25, wherein the suppressors of TNF- $\alpha$  are selected from the group comprising pentoxifylline, TACE inhibitors, amrinone, adenosine, thalidomide and dexamethasone.

\* \* \* \* \*



US 20060193835A1

(19) **United States**

(12) **Patent Application Publication**  
**Smith et al.**

(10) **Pub. No.: US 2006/0193835 A1**

(43) **Pub. Date: Aug. 31, 2006**

(54) **TREATMENT OF CONGESTIVE HEART FAILURE**

(30) **Foreign Application Priority Data**

Jan. 18, 2000 (CA)..... 2,296,997

(76) Inventors: **Eldon R. Smith**, Calgary (CA);  
**Guillermo Torre-Amione**, Bellaire, TX (US)

**Publication Classification**

Correspondence Address:  
**FOLEY & LARDNER LLP**  
**1530 PAGE MILL ROAD**  
**PALO ALTO, CA 94304 (US)**

(51) **Int. Cl.**  
*A61K 33/00* (2006.01)  
*A61K 35/14* (2006.01)  
(52) **U.S. Cl.** ..... **424/93.7; 424/600**

(21) Appl. No.: **11/218,922**

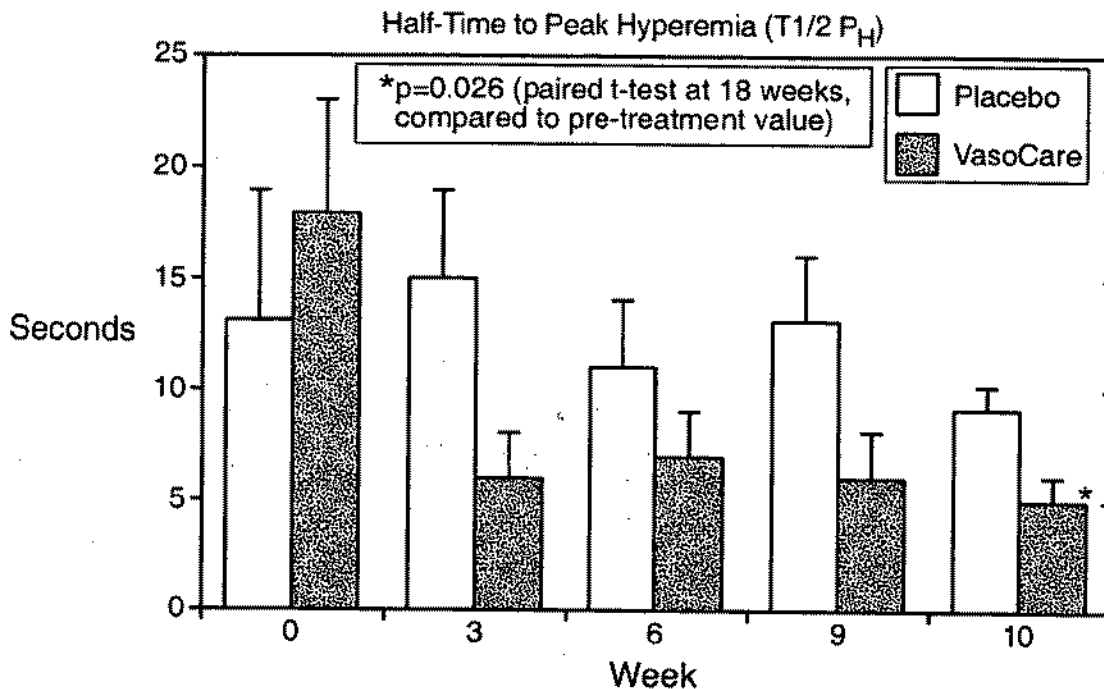
(57) **ABSTRACT**

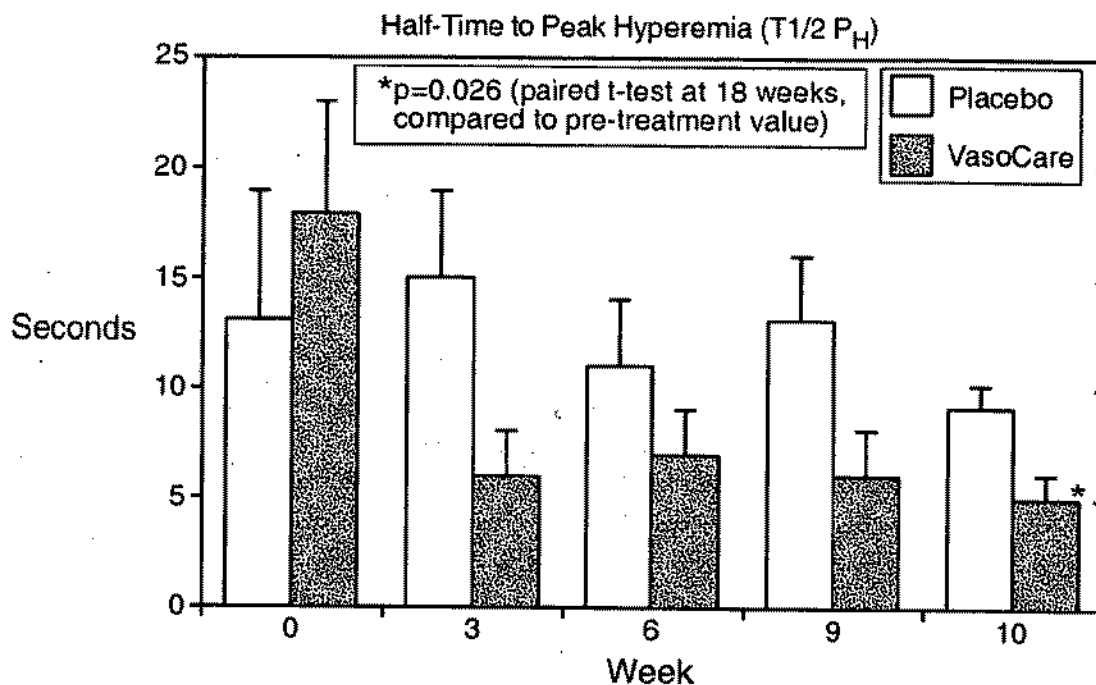
(22) Filed: **Sep. 1, 2005**

A method of treating congestive heart failure (CHF) in a human patient comprises treating an aliquot of the patient's blood ex vivo with at least one stressor selected from the group consisting of a temperature above or below body temperature, an electromagnetic emission and an oxidative environment, followed by administering the aliquot of treated blood to the patient. The treatment can be used on its own or as an adjunctive therapy in combination with conventional CHF treatments.

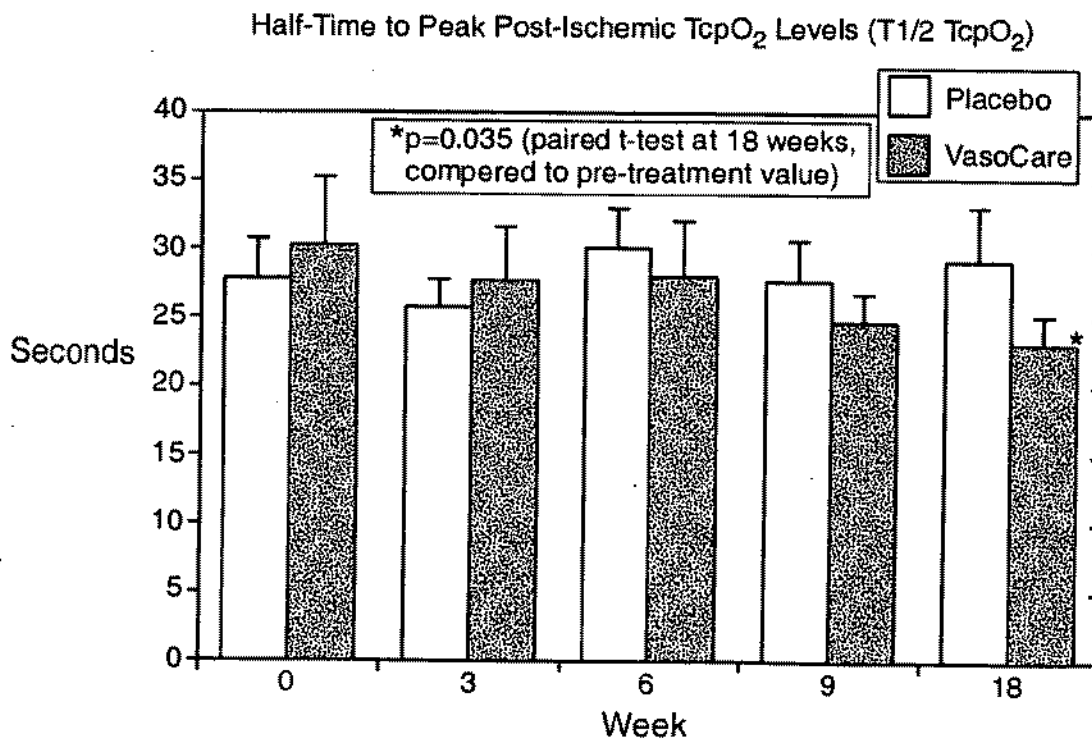
**Related U.S. Application Data**

(63) Continuation of application No. 10/278,920, filed on Oct. 24, 2002, which is a continuation of application No. 09/760,600, filed on Jan. 17, 2001, now Pat. No. 6,572,895.

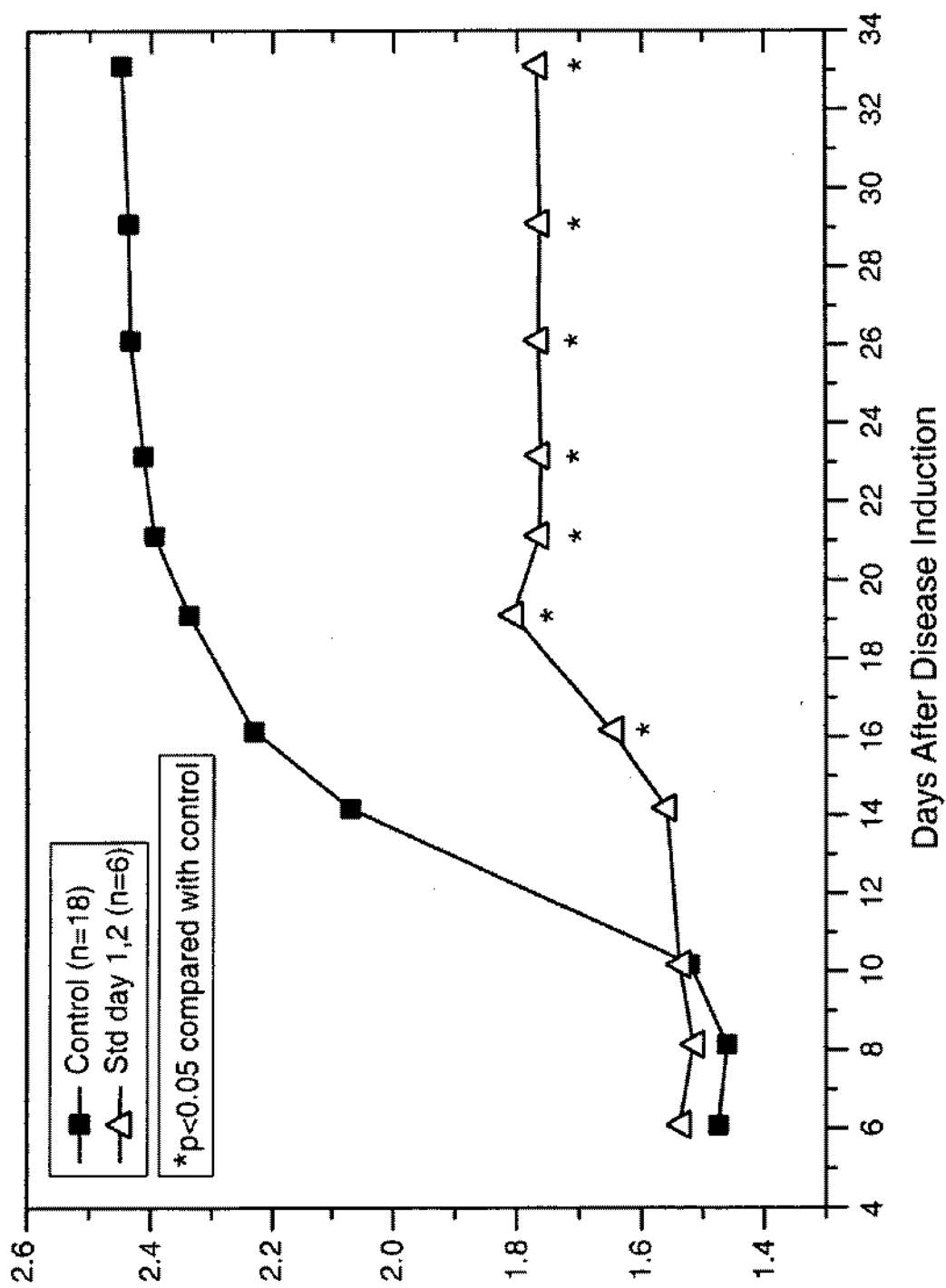




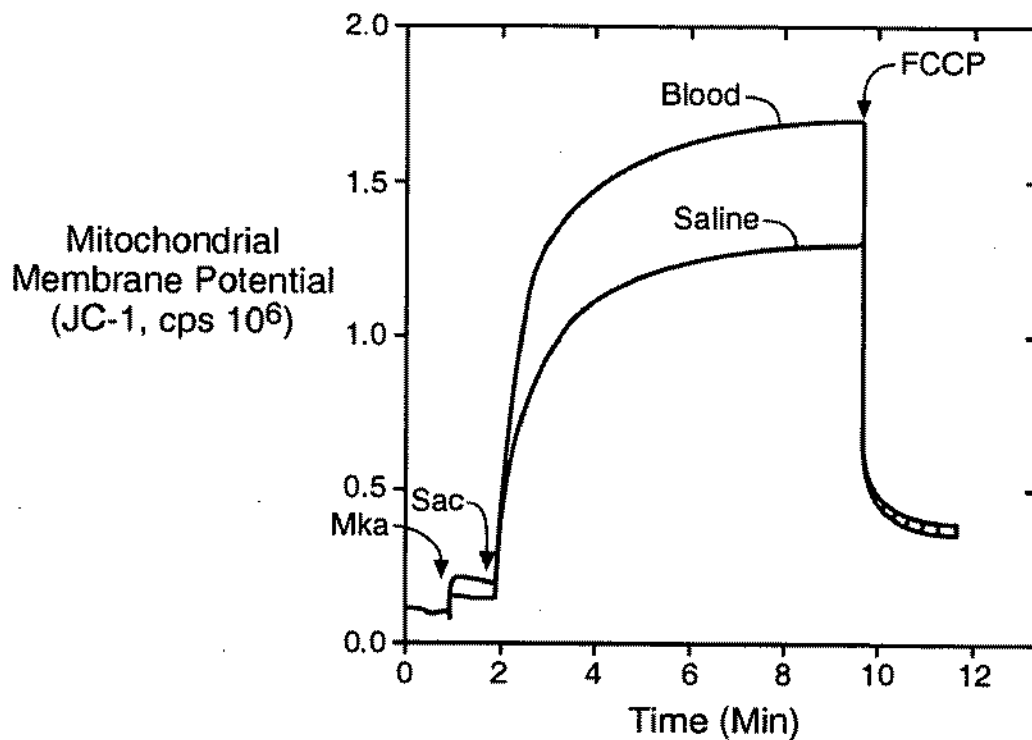
**FIG. 1**



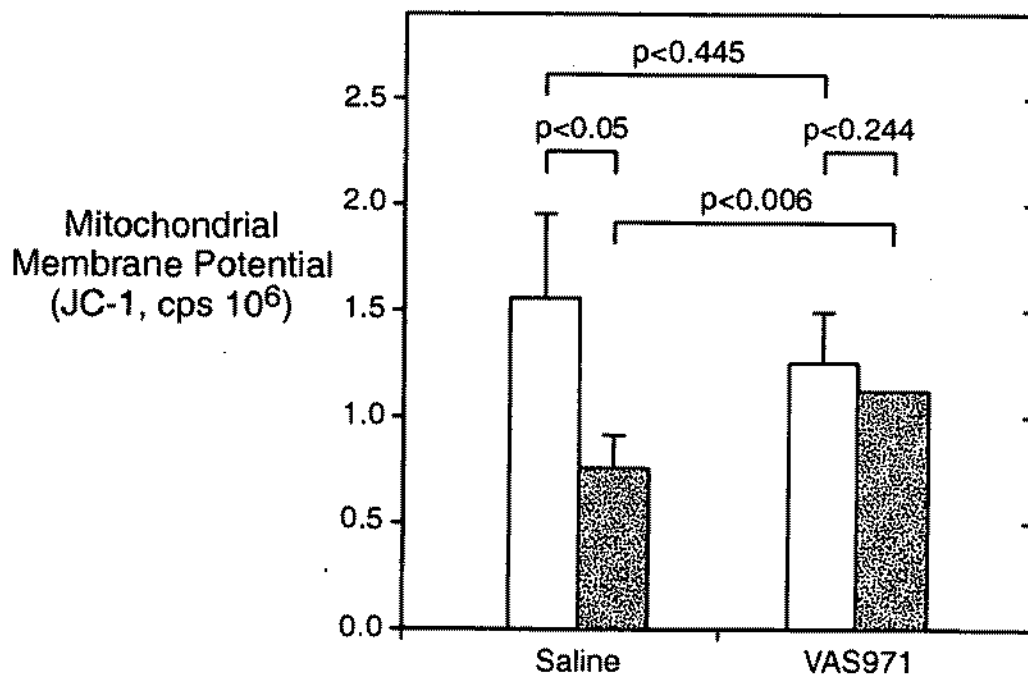
**FIG. 2**



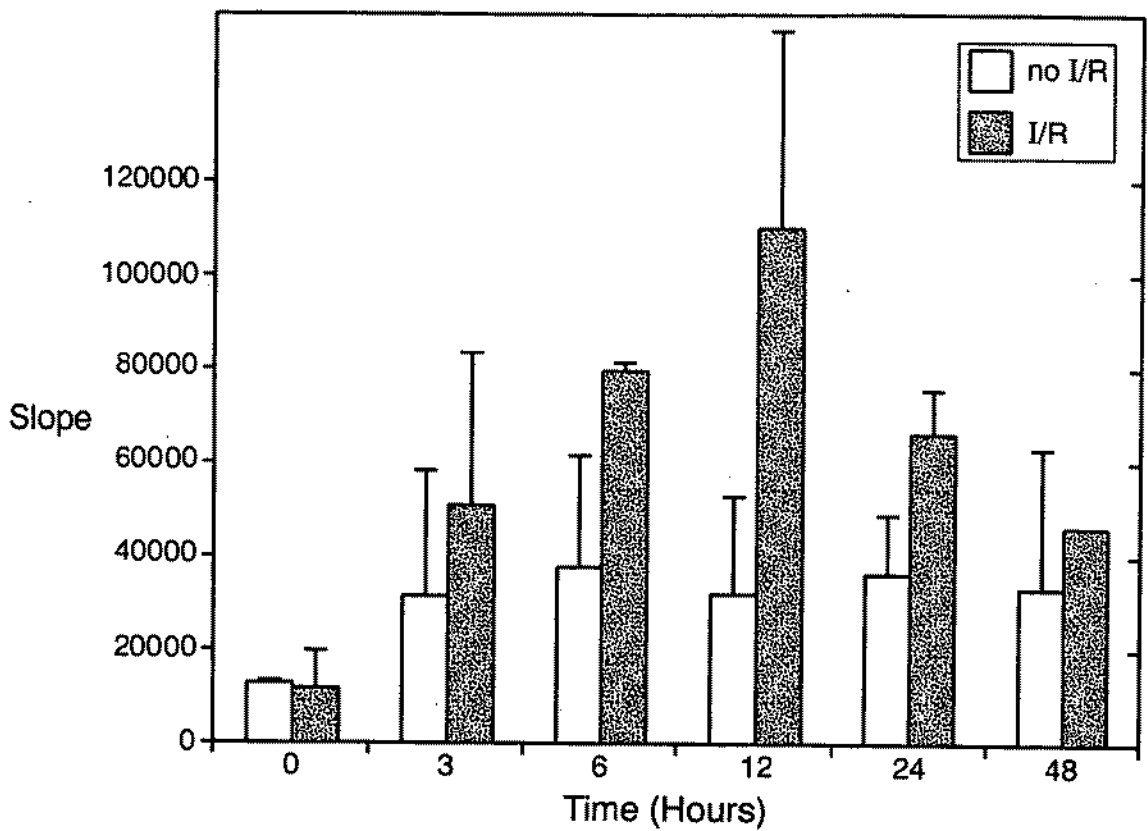
**FIG. 3**



**FIG. 4A**

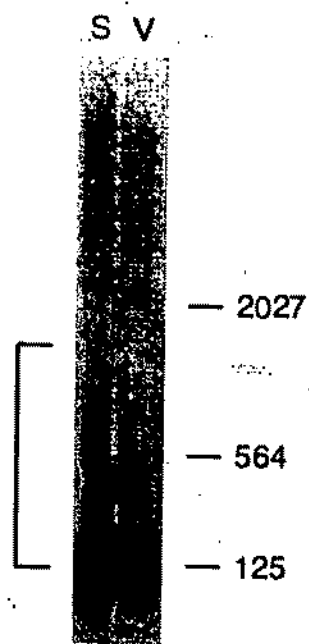


**FIG. 4B**

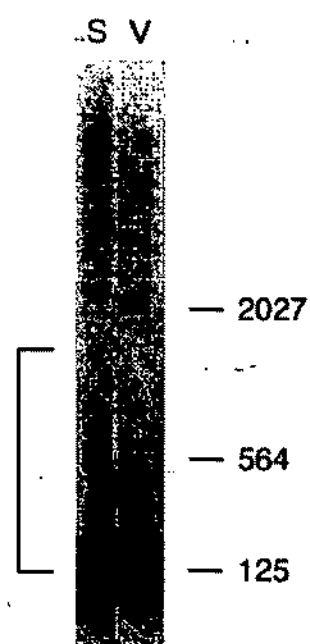


**FIG.\_5**

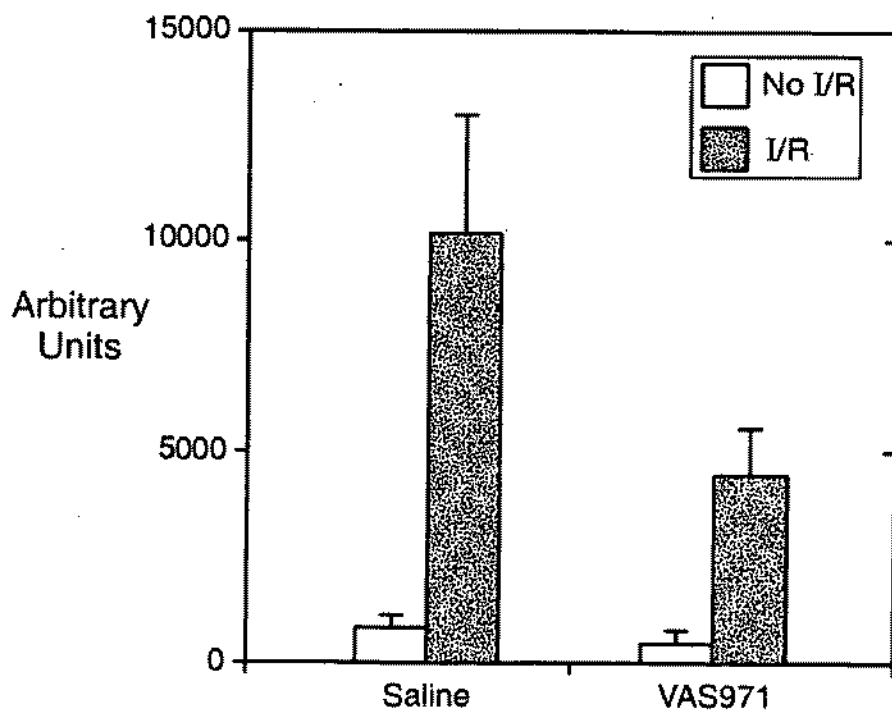




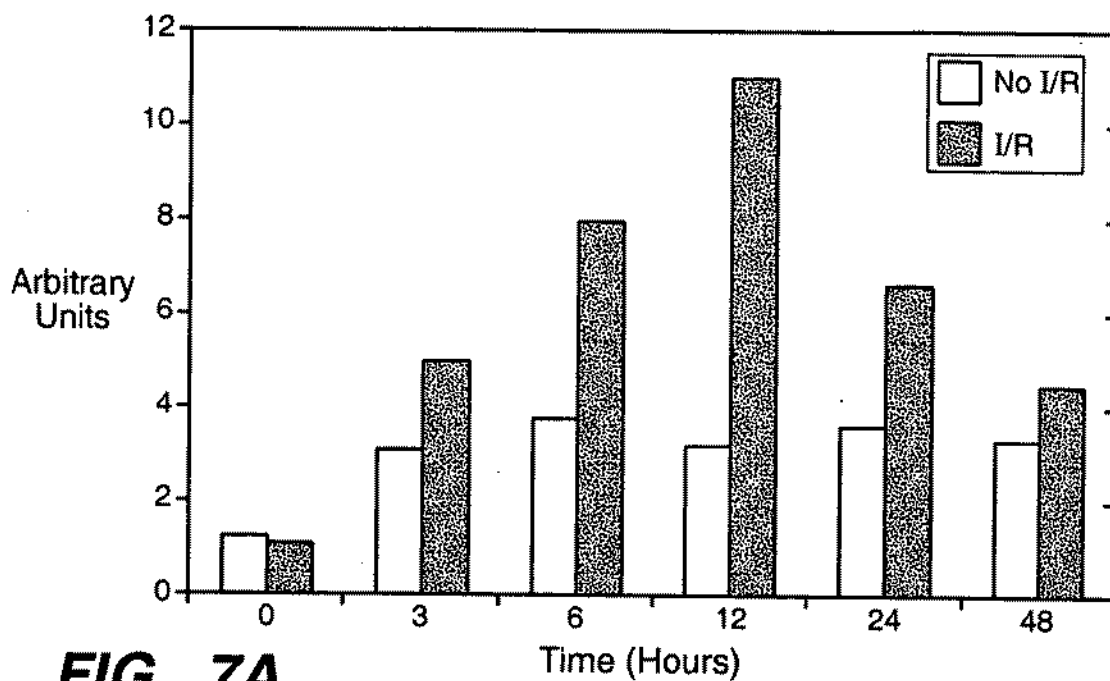
**FIG.\_6A**



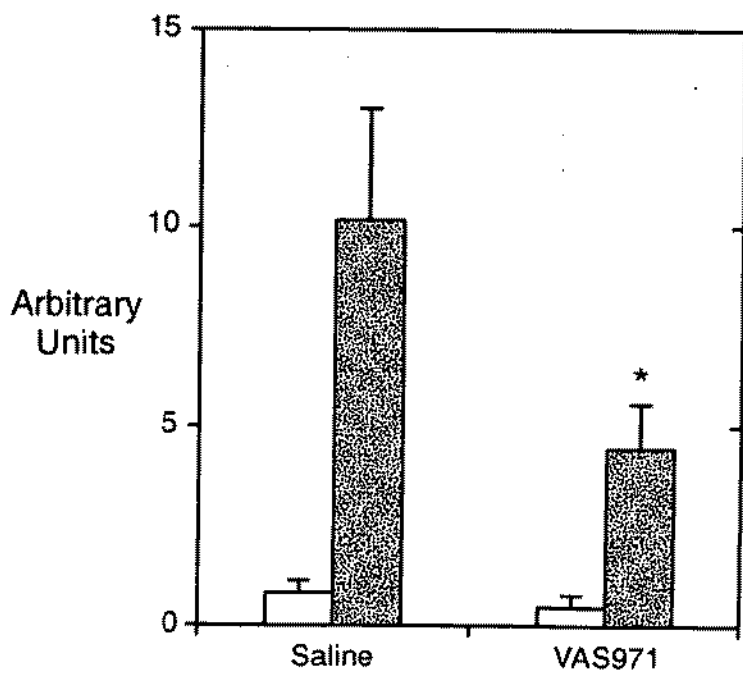
**FIG.\_7B**



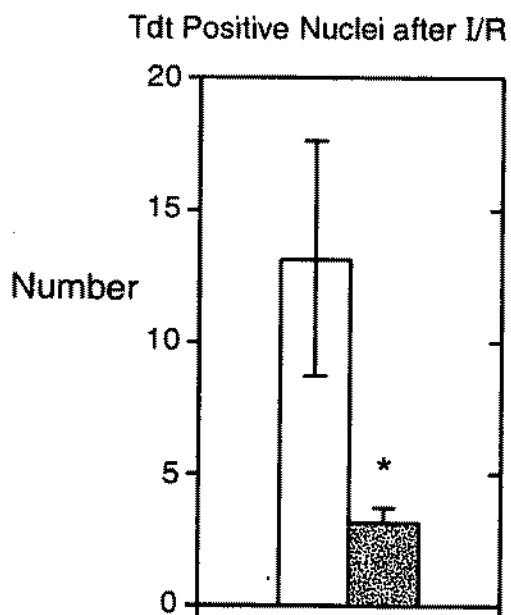
**FIG.\_6B**



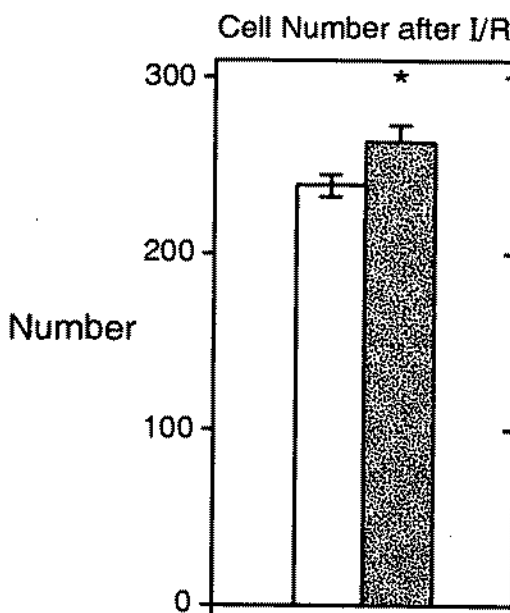
**FIG. 7A**



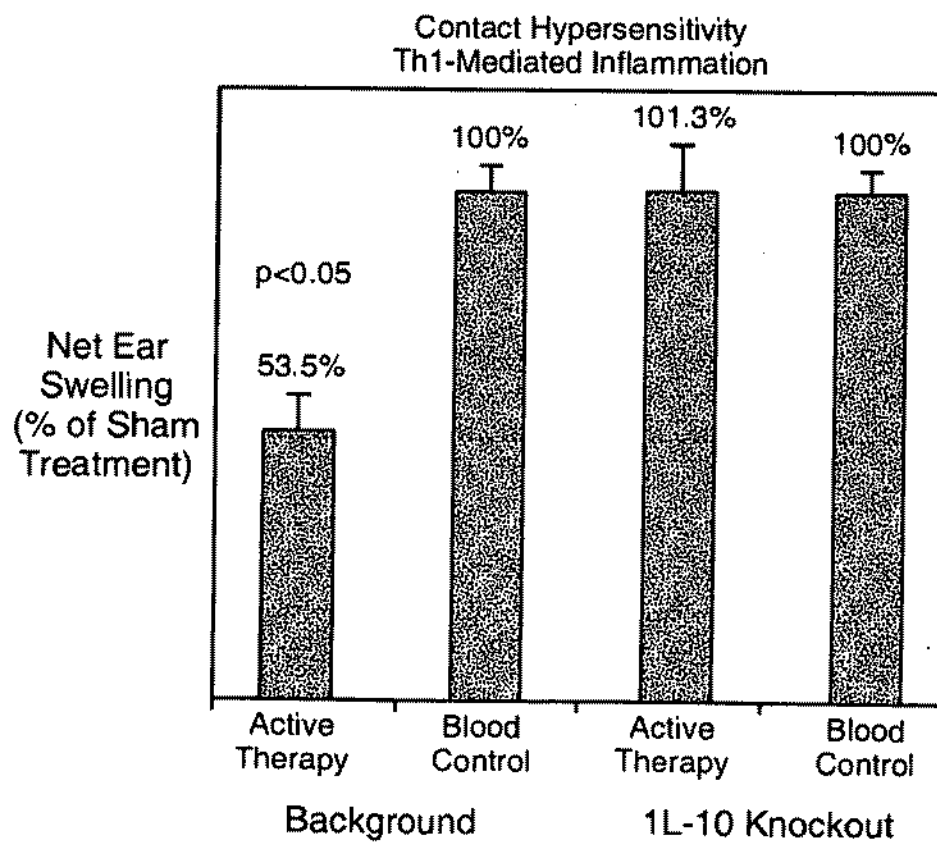
**FIG. 7C**



**FIG.\_8A**



**FIG.\_8B**



**FIG.\_9**

**TREATMENT OF CONGESTIVE HEART FAILURE****BACKGROUND OF THE INVENTION****[0001]** 1. Field of the Invention

**[0002]** This invention relates to methods for treating congestive heart failure, in particular by the administration to a human subject of an aliquot of modified blood, optionally in combination with one or more other treatments for alleviating the symptoms of congestive heart failure.

**[0003]** 2. Description of the Prior Art

**[0004]** Congestive heart failure (CHF) is a relatively common disorder affecting approximately five million Americans, with a mortality rate of over 80,000 per year. It is believed that CHF is not a distinct disease process in itself, but rather represents the effect of multiple anatomic, functional and biologic abnormalities which interact together to ultimately produce progressive loss of the ability of the heart to fulfill its function as a circulatory pump.

**[0005]** CHF may be caused by the occurrence of an index event such as a myocardial infarction (heart attack) or be secondary to other causes such as hypertension or cardiac malformations such as valvular disease. The index event or other causes result in an initial decline in the pumping capacity of the heart, for example by damaging the heart muscle. This decline in pumping capacity may not be immediately noticeable, due to the activation of one or more compensatory mechanisms. However, the progression of CHF has been found to be independent of the patient's hemodynamic status. Therefore, the damaging changes caused by the disease are present and ongoing even while the patient remains asymptomatic. In fact, the compensatory mechanisms which maintain normal cardiovascular function during the early phases of CHF may actually contribute to progression of the disease, for example by exerting deleterious effects on the heart and circulation.

**[0006]** Some of the more important pathophysiologic changes which occur in CHF are activation of the hypothalamic-pituitary-adrenal axis, systemic endothelial dysfunction and myocardial remodeling.

**[0007]** Therapies specifically directed at counteracting the activation of the hypothalamic-pituitary-adrenal axis include beta-adrenergic blocking agents ( $\beta$ -blockers), angiotensin converting enzyme (ACE) inhibitors, certain calcium channel blockers, nitrates and endothelin-1 blocking agents. Calcium channel blockers and nitrates, while producing clinical improvement have not been clearly shown to prolong survival whereas  $\beta$ -blockers and ACE inhibitors have been shown to significantly prolong life, as have aldosterone antagonists. Experimental studies using endothelin-1 blocking agents have shown a beneficial effect.

**[0008]** Systemic endothelial dysfunction is a well-recognized feature of CHF and is clearly present by the time signs of left ventricular dysfunction are present. Endothelial dysfunction is important with respect to the intimate relationship of the myocardial microcirculation with cardiac myocytes. The evidence suggests that microvascular dysfunction contributes significantly to myocyte dysfunction and the morphological changes which lead to progressive myocardial failure.

**[0009]** In terms of underlying pathophysiology, evidence suggests that endothelial dysfunction may be caused by a relative lack of NO which can be attributed to an increase in vascular  $O_2^-$  formation by an NADH-dependent oxidase and subsequent excess scavenging of NO. Potential contributing factors to increased  $O_2^-$  production include increased sympathetic tone, norepinephrine, angiotensin II, endothelin-1 and TNF- $\alpha$ . In addition, levels of IL-10, a key anti-inflammatory cytokine, are inappropriately low in relation to TNF- $\alpha$  levels. It is now believed that elevated levels of TNF- $\alpha$ , with associated proinflammatory cytokines including IL-6, and soluble TNF- $\alpha$  receptors, play a significant role in the evolution of CHF by causing decreased myocardial contractility, biventricular dilatation, and hypotension and are probably involved in endothelial activation and dysfunction. It is also believed that TNF- $\alpha$  may play a role in the hitherto unexplained muscular wasting which occurs in severe CHF patients. Preliminary studies in small numbers of patients with soluble TNF-receptor therapy have indicated improvements in NYHA functional classification and in patient well-being, as measured by quality of life indices.

**[0010]** Myocardial remodeling is a complex process which accompanies the transition from asymptomatic to symptomatic heart failure, and may be described as a series of adaptive changes within the myocardium. The main components of myocardial remodeling are alterations in myocyte biology, loss of myocytes by necrosis or apoptosis, alterations in the extracellular matrix and alterations in left ventricular chamber geometry. It is unclear whether myocardial remodeling is simply the end-organ response that occurs following years of exposure to the toxic effects of long-term neurohormonal stimulation, or whether myocardial remodeling contributes independently to the progression of heart failure. Evidence to date suggests that appropriate therapy can slow or halt progression of myocardial remodeling.

**[0011]** Although presently used treatments can alleviate symptoms of CHF and correct certain pathophysiologic abnormalities caused by the disease process, CHF remains a relentlessly progressive condition with a relatively high rate of mortality. In fact, relative reductions in morbidity and mortality brought about by existing drugs are on the order of about 10 to 25 percent. Therefore, the need exists for additive or superior treatments for CHF, especially those which can significantly modify the underlying disease.

**SUMMARY OF THE INVENTION**

**[0012]** The present invention overcomes at least some of the above-noted and other disadvantages of presently known CHF therapies by providing a method for treating CHF in which an aliquot of mammalian blood is treated *ex vivo* and subsequently introduced into the body of a mammalian subject.

**[0013]** The aliquot of blood is treated by being subjected to one or more stressors which have been found to modify the blood. According to the present invention, the blood aliquot can be modified by subjecting the blood, or separated cellular or non-cellular fractions of the blood, or mixtures of the separated cells and/or noncellular fractions of the blood, to stressors selected from temperature stressors, electromagnetic emissions and oxidative environments, or any combination of such stressors, simultaneously or sequentially.

[0014] As discussed above, the pathophysiologic changes associated with CHF include immune activation, endothelial dysfunction and loss of myocytes through necrosis and/or apoptosis. The treatment method of the present invention has been shown to produce therapeutic benefits in each of these three areas.

[0015] With respect to immune activation, the treatment of the present invention has been found to modulate levels of inflammatory cytokines in several Th1/TNF- $\alpha$ -dependent experimental inflammatory models in different species. For example, the treatment has been shown to reduce allergic contact hypersensitivity in Balb/c mice, a Th1-driven immune reaction mediated by TNF- $\alpha$  (Shivji et al., *Journal of Cutaneous Medicine and Surgery* 4: 132-137, 2000); to down-regulate expression of IL6 mRNA in adjuvant-induced arthritis in the Lewis rat model of inflammatory disease; and to decrease the proportion of Th1 to Th2 cells in patients with scleroderma, a Th1-driven autoimmune disease (Rabinovich et al., Poster presented at the XII Pan-American Congress of Rheumatology, Montreal, Canada, Jun. 21-25, 1998). It is believed that the treatment down-regulates the pro-inflammatory Th1-type immune response, for example by increasing anti-inflammatory Th2-type cytokines, including IL-10.

[0016] The treatment of the invention has been found to improve endothelial function in a number of studies conducted in humans and in animals. For example, the treatment has been found to improve endothelial-dependent vasodilator function in an open study on patients with severe primary Raynaud's disease (Cooke et al., *International Journal of Angiology* 16: 250-254, 1997), to improve the rate of recovery of skin blood flow following temporary occlusion in a double-blind, placebo-controlled study in patients with advanced peripheral vascular disease secondary to atherosclerosis (Courtman et al., *Circulation* Vol 102, #18, suppl II, 2000), to reduce progression of atherosclerosis in the cholesterol-fed LLD receptor deficient mouse (Babaei et al., *Journal of the American College of Cardiology* 35 (Suppl. A): 243, 1999), and to markedly improve endothelial-dependent vasodilator function to acetylcholine in severely atherosclerotic, hypercholesterolemic Watanabe rabbits as evidenced by an increased vasodilatory response to the nitric oxide agonist (acetylcholine) (Courtman et al., above). It is believed that the improvement in endothelial function is due to an anti-inflammatory effect and to increased availability of NO which may result in an improvement in vasodilatory capacity, known to be severely impaired in CHF patients.

[0017] With regard to myocyte loss, the method of the invention is believed to decrease levels of apoptosis and necrosis. It has been shown that the treatment can protect the kidney from ischemia/reperfusion (I/R) damage known to be associated with increased apoptotic cell death (Tremblay et al., *Pathophysiology* 5:26; Chen et al., *Médecine Sciences* 15 (Suppl. 1): 16), and can reduce apoptosis in the kidney following I/R as determined by DNA laddering and density of apoptotic nuclei stained by Tdt.

[0018] Because the treatment of the invention produces therapeutic benefits in three areas in which pathophysiologic changes occur in CHF, namely endothelial dysfunction, production of inflammatory cytokines and myocyte loss due to apoptosis, there is provided a strong theoretical basis on which to predict that the treatment of the invention would be

beneficial to patients with CHF. The method of the invention may be used as a CHF therapy on its own or in combination with other therapies, such as nitrate therapy,  $\beta$ -blockers, ACE inhibitors, AT receptor blocking agents, aldosterone antagonists, calcium channel blocking agents, TNF blocking agents, suppressors of production of TNF- $\alpha$ , and/or other more routine treatment measures such as sodium and fluid restriction, diuretics, digitalis, etc. Specific drugs known to suppress TNF- $\alpha$  production include pentoxifylline, amrinone, adenosine, thalidomide, TNF converting enzyme (TACE) inhibitors and dexamethasone. Specific TNF blocking agents include monoclonal antibodies and etanercept.

[0019] Accordingly, in one aspect the present invention provides a method of treating CHF in a human patient suffering therefrom, comprising: (a) treating an aliquot of the patient's blood ex vivo with at least one stressor selected from the group consisting of a temperature above or below body temperature, an electromagnetic emission and an oxidative environment; and (b) administering the aliquot of blood treated in step (a) to the patient, wherein the aliquot has a volume sufficient to alleviate CHF in the patient.

[0020] In another aspect, the present-invention provides a combination treatment for CHF in a human patient suffering therefrom, the combination treatment including the administration to the patient of an aliquot of the patient's own blood which has been treated ex vivo with one or more stressors selected from an oxidative environment, thermal stress and electromagnetic emission, and a treatment selected from the group consisting of nitrates,  $\beta$ -blockers, ACE inhibitors, AT receptor blocking agents, aldosterone antagonists, calcium channel blocking agents, TNF blocking agents, suppressors of production of TNF- $\alpha$ , sodium and fluid restriction, diuretics and digitalis.

#### BRIEF DESCRIPTION OF THE DRAWINGS

[0021] The invention is now described, by way of example only, with reference to the accompanying drawings in which:

[0022] FIGS. 1 and 2 of the accompanying drawings are graphical presentations of the results obtained from Example 2 described below;

[0023] FIG. 3 of the accompanying drawings is a graphical presentation of the results obtained from Example 3 described below;

[0024] FIG. 4 of the accompanying drawings is a graphical presentation of the results obtained from Example 4 described below;

[0025] FIGS. 5 to 8 of the accompanying drawings are graphical presentations of the results obtained from Example 5 described below; and

[0026] FIG. 9 of the accompanying drawings is a graphical presentation of the effects of the treatment of the invention in contact hypersensitivity Th1-mediated inflammation

#### DETAILED DESCRIPTION OF PREFERRED EMBODIMENTS

[0027] According to a preferred process of the present invention, an aliquot of blood is extracted from a mammalian subject, preferably a human, and the aliquot of blood is treated ex vivo with certain stressors, described in more

detail below. The terms "aliquot", "aliquot of blood" or similar terms used herein include whole blood, separated cellular fractions of the blood including platelets, separated non-cellular fractions of the blood including plasma, and combinations thereof. The effect of the stressors is to modify the blood, and/or the cellular or non-cellular fractions thereof, contained in the aliquot. The modified aliquot is then re-introduced into the subject's body by any route suitable for vaccination, preferably selected from intra-arterial injection, intramuscular injection, intravenous injection, subcutaneous injection, intraperitoneal injection, and oral, nasal or rectal administration.

[0028] The stressors to which the aliquot of blood is subjected *ex vivo* according to the method of the present invention are selected from temperature stress (blood temperature above or below body temperature), an oxidative environment and an electromagnetic emission, individually or in any combination, simultaneously or sequentially. Suitably, in human subjects, the aliquot has a volume sufficient that, when re-introduced into the subject's body, at least partial alleviation of CHF is achieved in the subject. Preferably, the volume of the aliquot is up to about 400 ml, preferably from about 0.1 to about 100 ml, more preferably from about 5 to about 15 ml, even more preferably from about 8 to about 12 ml, and most preferably about 10 ml, along with an anticoagulant, e.g. 2 ml sodium citrate.

[0029] It is preferred, according to the invention, to apply all three of the aforementioned stressors simultaneously to the aliquot under treatment, in order to ensure the appropriate modification to the blood. It may also be preferred in some embodiments of the invention to apply any two of the above stressors, for example to apply temperature stress and oxidative stress, temperature stress and an electromagnetic emission, or an electromagnetic emission and oxidative stress. Care must be taken to utilize an appropriate level of the stressors to thereby effectively modify the blood to alleviate CHF in the subject.

[0030] The temperature stressor warms the aliquot being treated to a temperature above normal body temperature or cools the aliquot below normal body temperature. The temperature is selected so that the temperature stressor does not cause excessive hemolysis in the blood contained in the aliquot and so that, when the treated aliquot is injected into a subject, alleviation of CHF will be achieved. Preferably, the temperature stressor is applied so that the temperature of all or a part of the aliquot is up to about 55° C., and more preferably in the range of from about -5° C. to about 55° C.

[0031] In some preferred embodiments of the invention, the temperature of the aliquot is raised above normal body temperature, such that the mean temperature of the aliquot does not exceed a temperature of about 55° C., more preferably from about 40° C. to about 50° C., even more preferably from about 40° C. to about 44° C., and most preferably about 42.5±1° C.

[0032] In other preferred embodiments, the aliquot is cooled below normal body temperature such that the mean temperature of the aliquot is within the range of from about -5° C. to about 36.5° C., more preferably from about 10° C. to about 30° C., and even more preferably from about 15° C. to about 25° C.

[0033] The oxidative environment stressor can be the application to the aliquot of solid, liquid or gaseous oxidiz-

ing agents. Preferably, it involves exposing the aliquot to a mixture of medical grade oxygen and ozone gas, most preferably by bubbling through the aliquot, at the aforementioned temperature range, a stream of medical grade oxygen gas having ozone as a minor component therein. The ozone content of the gas stream and the flow rate of the gas stream are preferably selected such that the amount of ozone introduced to the blood aliquot, either on its own or in combination with other stressors, does not give rise to excessive levels of cell damage such that the therapy is rendered ineffective. Suitably, the gas stream has an ozone content of up to about 300 µg/ml, preferably up to about 100 µg/ml, more preferably about 30 µg/ml, even more preferably up to about 20 µg/ml, particularly preferably from about 10 µg/ml to about 20 µg/ml, and most preferably about 14.5±1.0 µg/ml. The gas stream is suitably supplied to the aliquot at a rate of up to about 2.0 litres/min, preferably up to about 0.5 litres/min, more preferably up to about 0.4 litres/min, even more preferably up to about 0.33 litres/min, and most preferably about 0.24±0.024 litres/min, at STP. The lower limit of the flow rate of the gas stream is preferably not lower than 0.01 litres/min, more preferably not lower than 0.1 litres/min, and even more preferably not lower than 0.2 litres/min.

[0034] The electromagnetic emission stressor is suitably applied by irradiating the aliquot under treatment from a source of an electromagnetic emission while the aliquot is maintained at the aforementioned temperature and while the oxygen/ozone gaseous mixture is being bubbled through the aliquot. Preferred electromagnetic emissions are selected from photonic radiation, more preferably UV, visible and infrared light, and even more preferably UV light. The most preferred UV sources are UV lamps emitting primarily UV-C band wavelengths, i.e. at wavelengths shorter than about 280 nm. Such lamps may also emit amounts of visible and infrared light. Ultraviolet light corresponding to standard UV-A (wavelengths from about 315 to about 400 nm) and UV-B (wavelengths from about 280 to about 315) sources can also be used. For example, an appropriate dosage of such UV light, applied simultaneously with the aforementioned temperature and oxidative environment stressors, can be obtained from up to eight lamps arranged to surround the sample container holding the aliquot, operated at an intensity to deliver a total UV light energy at the surface of the blood of from about 0.025 to about 10 joules/cm<sup>2</sup>, preferably from about 0.1 to about 3.0 joules/cm<sup>2</sup>, may advantageously be used. Preferably, four such lamps are used.

[0035] The time for which the aliquot is subjected to the stressors is normally within the time range of up to about 60 minutes. The time depends to some extent upon the chosen intensity of the electromagnetic emission, the temperature, the concentration of the oxidizing agent and the rate at which it is supplied to the aliquot. Some experimentation to establish optimum times may be necessary on the part of the operator, once the other stressor levels have been set. Under most stressor conditions, preferred times will be in the approximate range of from about 2 to about 5 minutes, more preferably about 3 or about 3½ minutes. The starting blood temperature, and the rate at which it can be warmed or cooled to a predetermined temperature, tends to vary from subject to subject. Such a treatment provides a modified blood aliquot which is ready for injection into the subject.

[0036] In the practice of the preferred process of the present invention, the blood aliquot may be treated with the stressors using an apparatus of the type described in U.S. Pat. No. 4,968,463 to Mueller. The aliquot is placed in a suitable, sterile, UV light-transmissive container, which is fitted into the machine. The UV lamps are switched on for a fixed period before the gas flow is applied to the aliquot providing the oxidative stress, to allow the output of the UV lamps to stabilize. The UV lamps are typically on while the temperature of the aliquot is adjusted to the predetermined value, e.g.  $42.5 \pm 1^\circ$  C. Then the oxygen/ozone gas mixture, of known composition and controlled flow rate, is applied to the aliquot, for the predetermined duration of up to about 60 minutes, preferably 2 to 5 minutes and most preferably about 3 minutes as discussed above, so that the aliquot experiences all three stressors simultaneously. In this way, blood is appropriately modified according to the present invention to achieve the desired effects.

[0037] A subject preferably undergoes a course of treatments, each individual treatment comprising removal of a blood aliquot, treatment thereof as described above and re-administration of the treated aliquot to the subject. A course of such treatments may comprise daily administration of treated blood aliquots for a number of consecutive days, or may comprise a first course of daily treatments for a designated period of time, followed by an interval and then one or more additional courses of daily treatments.

[0038] In one preferred embodiment, the subject is given an initial course of treatments comprising the administration of 4 to 6 aliquots of treated blood. In another preferred embodiment, the subject is given an initial course of therapy comprising administration of from 2 to 4 aliquots of treated blood, with the administration of any pair of consecutive aliquots being either on consecutive days, or being separated by a rest period of from 1 to 21 days on which no aliquots are administered to the patient, the rest period separating one selected pair of consecutive aliquots being from about 3 to 15 days. In a more specific, preferred embodiment, the dosage regimen of the initial course of treatments comprises a total of three aliquots, with the first and second aliquots being administered on consecutive days and a rest period of 11 days being provided between the administration of the second and third aliquots. In the method of the invention, it is preferred that no more than one aliquot is administered to the subject on any given day.

[0039] It may be preferred to subsequently administer additional courses of treatments following the initial course of treatments. Preferably, subsequent courses of treatments are administered at least about three weeks after the end of the initial course of treatments. In one particularly preferred embodiment, the subject receives a second course of treatments comprising the administration of one aliquot of treated blood every 30 days following the end of the initial course of treatments, for a period of 6 months.

[0040] It will be appreciated that the spacing between successive courses of treatments should be such that the positive effects of the treatment of the invention are maintained, and may be determined on the basis of the observed response of individual subjects.

[0041] As discussed above, the method of the present invention may preferably be used as an adjunctive treatment in combination with other therapies for CHF. Preferred

examples of such other therapies include one or more of ACE inhibitors,  $\beta$ -blockers, aldosterone antagonists, TNF blockers, suppressors of TNF production and other forms of routine therapy.

[0042] The invention is further illustrated and described with reference to the following specific examples.

#### EXAMPLE 1

[0043] This example describes a study conducted to determine the effect of the treatment of the invention on endothelial function in Watanabe rabbits, known to develop complex atherosclerotic lesions during the first year of life. As previously mentioned, endothelial dysfunction is linked to the pathophysiology of CHF.

[0044] The rabbits entered the study at 7 to 8 months of age, and were randomized into three groups, a first group to be sacrificed immediately for baseline measurements, a second group (n=10) which received injections of blood treated according to the invention, and a third group (n=10) which received sham treatments comprising injections of untreated blood.

[0045] The treatment comprised a total of 4 injections of treated blood over a period of 10 weeks. The blood was treated by exposure to the following three stressors in an apparatus as generally described in U.S. Pat. No. 4,968,483 to Mueller et al.:

[0046] (a) an elevated temperature of  $42.5^\circ$  C.  $\pm 1.0^\circ$  C.;

[0047] (b) a gas mixture of medical grade oxygen containing  $14.5 \pm 1.0$   $\mu$ g/ml of ozone, bubbled through the blood at a flow rate of  $240 \pm 24$  ml/min for 3 minutes; and

[0048] (c) ultraviolet light at a wavelength of 253.7 nm, and a total energy density of 2.0 joules/cm<sup>2</sup> (with some fluctuation within the previously mentioned range).

[0049] The treated blood was administered to the animals by intra-muscular injection. The control animals were administered intra-muscular injections of untreated blood on the same injection schedule as the treated animals.

[0050] All animals were sacrificed at 11 months of age. Ring preparations were taken from the iliac arteries of the animals and were evaluated for the amount of relaxation induced by acetylcholine (an endothelial-dependent vasodilator) after being treated with phenylephrine (a vasoconstrictor).

[0051] Evaluation of the ring preparations showed a significant increase in endothelial-mediated vasorelaxation ( $52.2 \pm 6\%$ ) was observed in the treated animals as compared to the control animals injected with untreated blood ( $22.9 \pm 4\%$ , p less than 0.001).

[0052] No relaxation was observed when the endothelium was removed from the ring preparations, further confirming the endothelium-specific effect of the treatment of the invention.

#### EXAMPLE 2

[0053] This example describes a study into the effects of the treatment of the invention therapy on patients suffering

from peripheral vascular disease (PVD). The study was conducted at the University Hospital, Lund, Sweden.

[0054] The study comprised a placebo-controlled, double blind study in 18 patients (7 males, 11 females) with moderately advanced PVD, whose main symptom was intermittent claudication. The patients participating in the study were recruited from the attending population of the Department of Internal Medicine of the University Hospital, Lund, Sweden.

[0055] The patients were randomly assigned to receive either placebo (intramuscular injection of 10 ml warm saline) or treatment according to the invention comprising intramuscular injections of 10 ml of treated autologous blood. The treatment of the blood involved the collection of a 10 ml aliquot of a patient's venous blood into 2 ml of sodium citrate 3-4% as anticoagulant. Each blood aliquot was transferred to a sterile, disposable low-density polyethylene vessel and then exposed to the following conditions in an apparatus as generally described in U.S. Pat. No. 4,968,483 to Mueller et al.:

[0056] (d) elevated temperature of  $42.5^{\circ}\text{C} \pm 1.0^{\circ}\text{C}$ ;

[0057] (e) medical oxygen containing  $14.5 \pm 1.0$  ug/ml of ozone bubbled through the blood aliquot at a flow rate of  $240 \pm 24$  ml/min at STP for 3 minutes; and

[0058] (f) ultra-violet light at a wavelength of 253.7 nm, and a total energy of about 2.0 joules/cm<sup>2</sup>.

[0059] Each patient received a total of 12 injections of saline or treated blood over a period of 9 weeks.

[0060] The therapy was assessed by measuring the recovery rate of skin blood flow and oxygen tension following total temporary occlusion of blood flow in the extremities of each patient prior to commencement of the therapy and at 3 weeks, 6 weeks, 9 weeks and 2 months following the initiation of the therapy.

[0061] Skin blood flow in the foot was measured by Laser Doppler Fluxmetry (LDF) and oxygen tension was determined by measurement of transcutaneous skin oxygen pressure (TepO<sub>2</sub>) in the foot. In patients receiving the treatment of the invention, a strong trend was observed toward a treatment-related reduction in both the total time to reach maximum perfusion (TP<sub>B</sub>) and the half-time to reach maximum perfusion (T<sub>1/2</sub>P<sub>B</sub>) indicative of an improvement in the rate of recovery of skin blood flow. No change was observed in the control group.

[0062] The improved rate of recovery of blood flow in patients treated according to the invention was apparent during the course of treatments and persistent throughout, but did not reach significance until 2 months following initiation of the therapy. A comparison of the T<sub>1/2</sub>P<sub>B</sub> for the placebo and treated groups, as measured by LDF, is shown in FIG. 1.

[0063] There was also an observed trend toward more rapid recovery of skin oxygen content in the treated group. This difference became statistically significant at 2 months following the initiation of the therapy. A comparison of the half-time to maximum TepO<sub>2</sub> after ischemia (O<sub>2</sub>T<sub>1/2</sub>) for the treated group compared to the placebo group is shown in FIG. 2.

[0064] The study therefore demonstrated that, in this group of moderately advanced PVD patients, the treatment of the invention had a clear biological effect on the rate at which blood flow in the skin of the foot was recovered following a period of total occlusion ischemia. A similar effect, but of smaller magnitude, was noted for the rate of TepO<sub>2</sub> recovery, whereas patients receiving placebo treatment showed no change. These results suggest that the treatment of the invention has a beneficial effect on endothelial function, and appears to improve skin microcirculatory function in patients with PVD.

#### EXAMPLE 3

[0065] This example relates to the use of the treatment of the invention to prevent the onset of arthritis, and describes the results of a study conducted in an established animal model of arthritis. The specific animal model used in this study was adjuvant-induced arthritis in rats (see, for example, Pearson, C., 1956, "Development of Arthritis, peri-arthritis and periostitis in rats given adjuvant", *Proc. Soc. Exp. Biol. Med.*, 91:95). According to this model, arthritis is induced in rats by injecting them with adjuvant containing *Mycobacterium butyricum*.

[0066] Male Lewis rats, 4 to 5 weeks of age, 100 to 120 g, were obtained from Charles River Laboratories, quarantined one week and entered into the study. An adjuvant mixture was prepared for induction of arthritis by suspending 50 mg *M. butyricum* (Difco Laboratories, Inc., Detroit, Mich.) in 5 ml light white paraffin oil—m3516 (Sigma Chemical Co., St. Louis, Mo.) and thoroughly mixed using a homogenizer. Aliquots of the mixture sufficient to supply 0.15 mg *M. butyricum* was injected into each animal subcutaneously, at the base of the tail. Symptoms of arthritis appeared about 12 days after induction, in each animal, as evidenced by limb swelling.

[0067] Two rats, which were not injected with the adjuvant mixture, were used as blood donors. Blood was collected from the donors by cardiac puncture, and 10 ml of citrated blood was transferred to a sterile, low density polyethylene vessel for ex vivo treatment with stressors according to the invention. Using an apparatus as generally described in the above-mentioned Mueller patent, the blood was stressed by a treatment according to the invention.

[0068] Six animals were given a course of 2 injections of 0.2 ml aliquots of the treated blood, the injections being administered on consecutive days after the onset of arthritis. A control group of 8 rats received injections of untreated blood using the same injection schedule as the treated animals. Injections commenced one day after the induction of arthritis. Hind paw volumes of the animals were measured, on alternate days, after onset of arthritis, by water displacement in a 250 ml beaker using a top-loaded Mettler balance. The results for each group of animals were averaged and are presented graphically on the accompanying FIG. 3, a plot of mean foot volume against days after induction of arthritis. The upper curve is derived from the control group of animals, the lower curve from the animals which received the course of injections of treated blood. A significant decrease in the severity of the arthritis, as indicated by lower foot volumes, is apparent for the treated animals as compared to the animals of the control group.



[0069] The above results show that treatment of subjects with modified mammalian blood can effectively prevent the onset of arthritis in mammals.

[0070] The expression of IL-6 mRNA in lymph nodes of treated and untreated animals was measured 10 days after induction of arthritis, and the results are presented below in Table 1.

TABLE 1

Treatment	IL-6 copy no. (per 4500 actin units)
Active	<35 (n = 8)
Control	254 ± 203 (n = 8)

[0071] The results shown above in Table 1 show that the treatment according to the invention can modulate levels of inflammatory cytokines in a Th1/TNF- $\alpha$ -dependent model of arthritis. There is evidence that production of inflammatory cytokines such as IL-6 and TNF- $\alpha$  is linked to the pathophysiology of CHF.

## EXAMPLE 4

[0072] The experiment reported in this example demonstrates, by use of an animal model system involving ischemia and subsequent reperfusion of various body organs, that the treatment of the present invention has the effect of reducing apoptosis and necrosis. Ischemia-reperfusion injuries are known to involve increase of apoptosis and necrosis in the affected organs and tissues—see for example Salkumar p, et al. “Mechanisms of cell death in hypoxia/reoxygenation injury”, *Oncogene* Dec. 24, 1998; 17(25):3341-9; and Burns A. T. et. al., “Apoptosis in ischemia/reperfusion injury of human renal allografts”, *Transplantation*, Oct. 15, 1998; 66(7): 872-6, and other publications both preceding and following those. Known techniques of determination of apoptosis at the cellular level are employed in this example.

[0073] Pure-bred normal beagle dogs, aged 1-2 years, equal numbers of males and females, were used as the experimental animals. The animals were separated into four groups, A, B, C and D, each group consisting of six animals, three males and three females. Animals of groups A and C were subjected to the process of the invention, by being subjected to two 10-day courses of daily removal of an 8 ml aliquot of blood, extracorporeal treatment of the aliquot with oxygen/ozone, UV radiation and heat, and re-administration of 5 ml of the treated aliquot to the sane animal, by intramuscular injection.

[0074] Each such treatment was conducted as follows.

[0075] An 8-ml aliquot of blood was extracted from the animal, treated with sodium citrate (2 ml) and placed in a sterile container. It was subjected simultaneously to the UV radiation, oxygen/ozone gas oxidative environment and elevated temperature stressors, in an apparatus as generally described in the aforementioned Mueller U.S. Pat. No. 4,969,483. More specifically, the blood sample in the sterile, UV-transparent container was heated using infra-red lamps to 42.5° C., and whilst being maintained at that temperature, it was subjected to UV radiation of predominant wavelength 253.7 nm under the preferred conditions previously described. Simultaneously, a mixture of medical grade oxygen and ozone, of ozone content 13.5-15.5  $\mu$ g/ml was

bubbled through the blood sample at a flow rate within the range from 60-240 mls/min (STP). The time of simultaneous UV exposure and gas mixture feed was 3 minutes. A 5 ml portion of the treated blood aliquot was reinjected intramuscularly into each test animal.

[0076] Each animal of groups A and C, receiving the courses of treatment according to the invention, experienced a three week rest period between the 10-day courses of treatment. Groups B and D were the control groups, given two 10-day courses of daily injections of 5 ml of physiological saline, with a three-week rest period between the 10-day courses.

[0077] One day following the second course of injections, the animals were anaesthetized under light gas anaesthesia, and the right kidney of each animal was removed through a back incision. An occlusive clip was placed on the remaining renal artery and vein, to expose the left kidney to transient ischemia, for 60 minutes. Then the clip was removed to allow reperfusion of the kidney by normal blood flow.

[0078] The animals were observed for 6 days after the ischemia procedure, and then sacrificed. The ischemic kidney of each animal was surgically removed and divided into two parts. One part was kept frozen at -80° C., and the other part was fixed in 10% formalin for immuno- and routine histopathology studies.

[0079] Mitochondrial membrane potential was measured in proximal tubular cells isolated from the ischemic and control kidneys, both at the time of removal of the control kidney and following sacrifice. For this purpose, dog kidney proximal tubes were purified from normal or ischemic kidney cortexes by the collagenase treatment procedure described by Marshansky et. al., “Isolation of heavy endosomes from dog proximal tubes in suspension”, *J. Membr. Biol* 153(1), 59-73, 1996. Renal mitochondria were isolated in suspension by differential centrifugation (see Marshansky, “Organic hydroperoxides at high concentrations cause energization and activation of AATP synthesis in mitochondria”, *J. Biol. Chem.* 264(7), 3670-3673, 1989, after tissue homogenization in a buffer containing 250 mM sucrose, 10 mM HEPES-Tris (pH 7.5), and 250  $\mu$ M EDTA. Cell debris was removed by centrifugation at 10,000 g for 30 minutes. The mitochondria were washed with the sucrose/HEPES buffer without EDTA.

[0080] Mitochondrial membrane potential was measured as described by Kroemer, G., Zamzam, N. and Susin, S. A., “Mitochondrial control of apoptosis”, (Review) *Immunology Today* (1997) v. 18, p 44-51; with JC-1 dye—see Salvioli et. al., “JC-1, but not DiOC6(3) or rhodamine 123, is a reliable fluorescent probe to assess delta psi changes in intact cells: implications for studies on mitochondrial functionality during apoptosis”, *FEBS Letters* 411 (1), 77-82, 1987. JC-1 fluorescence in the suspension of purified mitochondria from normal and ischemic kidneys was monitored continuously on a Deltascan Model RFM-2001 spectrofluorimeter (Photon Technology International, South Brunswick, N.J.). The excitation wavelength was 490 nm (slit width 2 nm) and the emission wavelength was 590 nm (slit width 4 nm). The signals were recorded using Felix® (Version 1.1) software. All measurements were performed with continuous stirring at 37° C. The incubation buffer for measurement of mitochondrial membrane potential contained 200 mM sucrose, 5 mM MgCl<sub>2</sub>, 5 mM KH<sub>2</sub>PO<sub>4</sub>, 0.1

$\mu\text{M}$  of JC-1 and 30 mM HEPES-Tris (pH 7.5). The concentrations of the substrate and inhibitors were 10 mM succinate, 0.1  $\mu\text{M}$  rotenone with or without 0.1  $\mu\text{M}$  FCCP. Proximal tubule mitochondrial membrane potential was estimated in the right (control) kidney prior to ischemia and in the left (ischemic) kidney after sacrifice of the dogs on day 6 following ischemia and was estimated as difference of JC-1 fluorescence after uncoupling of mitochondria with FCCP as shown in the accompanying FIG. 4A. For each measurement, 50  $\mu\text{g}$  protein of purified material was used.

[0081] JC-1 fluorescence is proportional to the mitochondrial membrane potential. The contralateral nephrectomized kidney served as control. As is clear from the FIG. 4B, the treatment process of the invention did not modify the membrane potential of the non-ischemic control right kidney ( $p=0.445$  for treated vs saline). However, the ischemic kidney of the saline-injected animals showed significantly lower ( $p<0.05$ ) fluorescence compared to the control kidney. The stress treatment according to the invention prevented the uncoupling of mitochondria during ischemic/reperfusion, and membrane potential showed no significant difference ( $p=0.244$ ) between ischemic and control kidneys. This parameter remained significantly higher ( $p=0.0006$ ) vs saline-injected dogs) in the ischemic kidneys of dogs pre-treated according to the process of the invention for at least 6 days post-reperfusion.

[0082] These results indicate that the process of the invention effects protection of the kidney against apoptosis and/or accelerates recovery at the mitochondrial level. Accordingly the process of the invention is indicated for pre-conditioning of the cells, tissues and organs of a mammalian body against subsequently encountered factors which will normally accelerate apoptosis.

[0083] Specifically, the preservation of mitochondrial membrane potential evidences the capacity of the therapy to protect mitochondria, and thereby to precondition cells against apoptosis.

#### EXAMPLE 5

[0084] A group of 12 male SHR rats was treated with either injections of pooled blood stressed as described in Example 4 above, or, in control animals, with injections of saline. Since the blood from all of the animals of this genetic strain is identical, blood from one animal of this same strain was treated by the process of the invention for administration to the test animal. The blood was treated with sodium citrate as anticoagulant, and placed in a sterile container. They received either injections of 150  $\mu\text{l}$  of stressed blood on days -14 and -13 followed by a rest period of 11 days and a third injection the day before ischemic surgery, or injections in parallel with saline. On the day of surgery, the rats were anaesthetized with light flurane, and the right kidney was removed through a mid-abdominal incision. The left kidney was then subjected to transient ischemia by occlusion of the left renal artery and vein using a micro-clip. The skin was then temporarily closed. After 60 minutes of occlusion, the clip was removed and the wound was closed with a suture. The animals were sacrificed 12 hours after reperfusion.

[0085] The ischemic and non-ischemic kidneys of the test animals were removed and subjected to DNA laddering tests. Oligonucleosomal DNA fragmentation into 180 to 200 base pairs is a specific pattern which appears as a ladder after

agarose gel electrophoresis in various organs undergoing apoptosis. To estimate the degree of DNA fragmentation in the kidney cortex, an aliquot of pulverized kidney cortex was weighed and total tissue DNA was extracted by the phenol-chloroform procedure after tissue digestion with a proteinase K and RnaseA in the presence of EDTA. One  $\mu\text{g}$  of extracted DNA was labeled by enzymatic assay using terminal deoxynucleotidyl transferase with  $\text{P}^{32}$ -dCTP (see Teiger et. al., 'Apoptosis in pressure overload-induced heart hypertrophy in the rat', J. Clin. Invest. 97, 2891-2897, 1996). Increasing quantities of radio-labelled DNA were loaded onto 1.5% agarose gels. After electrophoresis, DNA was transferred onto nylon membranes (Hybond) and the radioactivity associated with 150 to 1500 bp DNA fragments was quantified in a Phosphorimager (Molecular Dynamics). A regression line for each sample was drawn for the radioactivity as a function of DNA loaded on the gel (see deBlois et. al., 'Smooth muscle cell apoptosis during vascular regression in spontaneously hypertensive rats.' Hypertension 29, 340-349, 1997). The slope of the linear regression line served as a DNA fragmentation index (cpm/pixel per  $\mu\text{g}$  DNA).

[0086] The results from ischemic-reperfused (I/R) kidneys and from normal, non-I/R kidneys, all from animals which did not receive injections of stressed blood, are shown graphically on FIG. 5, a plot of the slope of the regression lines for the various samples (vertical axis) against time after initiation of reperfusion. The DNA laddering, indicative of DNA fragmentation, was clearly increased in the ischemic kidney cortex compared to the contralateral non-ischemic organ and the maximal attained at twelve hours returned to near basal values by 48 hours. Twelve hours was thus selected as the time point for study of the effect of the stressed blood of the invention on early ischemia-induced renal apoptosis.

[0087] FIG. 6A of the accompanying drawings is a picture of the electrophoresis gel of the fragmented DNA, in the 150-1500 bp range, radio-labeled as described to attach radioactivity labels to the DNA fragments. Trace S derives from DNA of kidneys from animals which received saline injections prior to kidney ischemia-reperfusion, and trace V derives from DNA of kidneys of animals which received injections of the stressed blood prior to kidney ischemia-reperfusion. The Figure shows that 60 minutes renal ischemia induced a clear accumulation of fragmented DNA in both groups of rats at 12 h but the level of this parameter was significantly lower ( $p<0.05$ ) in animals receiving the treated blood. FIG. 6B quantifies the amount of irradiation from the samples, in arbitrary units, and shows that DNA fragmentation-laddering occurs in both S and V samples as a result of ischemia/reperfusion, but that the extent is markedly reduced in V samples as compared with S samples. The results presented on FIG. 68 are the means of six animals in each case.

[0088] These results confirm that the cytoprotective effect of the administration of stressed blood according to the invention on renal reperfusion injury involves the inhibition of early or late apoptosis.

[0089] The ability of the treatment of the invention in reducing apoptosis in the kidney following ischemia/reperfusion during the early phase of apoptosis (after 12 hours) as determined by DNA laddering and density of apoptotic

nuclei stained by Tdt is shown in **FIGS. 7 and 8**, respectively. As well, **FIG. 3B** shows that cell numbers in the kidney following ischemia/reperfusion were also significantly higher in the animals treated according to the invention.

#### EXAMPLE 6

[0090] This example describes the treatment of a small number of human patients with advanced chronic congestive heart failure. The patients had NYHA class III-IV chronic congestive heart failure, with a left ventricular ejection fraction (LVEF) of less than 40% and a 6 minute walk distance of less than 300 m. Some of the patients had previously received other CHF treatments.

Protocol:

[0091] Patients receive a number of injections of treated blood. The treatment schedule comprises injections on days 1, 2 and 14, followed by a single injection every 30 days for 5 months, each injection having a volume of 10 ml. Each individual treatment comprises the following steps:

[0092] 1. Collection of 10 ml of a patient's own venous blood into 2 ml of 3-4% sodium citrate for injection, USP. The sodium citrate is added to the sample to prevent the blood from coagulating during the treatment.

[0093] 2. Transfer of the citrated blood sample to a sterile, disposable, low-density polyethylene vessel.

[0094] 3. Ex vivo treatment of the blood sample by simultaneous exposure to:

[0095] an elevated temperature of  $42.6 \pm 1.0^\circ \text{C}$ ,

[0096] a gas mixture of medical grade oxygen containing  $14.5 \pm 1.0 \mu\text{g/ml}$  of ozone which is bubbled through the blood sample at a flow rate of  $240 \pm 24 \text{ ml/min}$  (at STP); and

[0097] ultraviolet light at a wavelength of 253.7 nm.

[0098] 4. Transfer of the blood sample from the sterile disposable container to a sterile syringe.

[0099] 5. Intramuscular injection of 2 ml or 10 ml of the treated blood sample into the gluteal muscle of the same patient, following a local anaesthetic (1 mL of 2% Novocain or equivalent) at the injection site.

[0100] The ex vivo treatment of the blood sample described in step (3) above is performed with an apparatus as generally described in U.S. Pat. No. 4,968,483 to Mueller et al. The blood sample is simultaneously exposed to all three stressors for a period of 3 minutes.

Assessment of CHF:

[0101] Patients are monitored for adverse events during each visit. As well, a post-treatment follow-up is conducted to monitor survival, hospitalizations, and significant adverse events.

[0102] The primary endpoints used to assess the effectiveness of the treatment are changes in 6-minute walking distance and/or NYHA functional classification. Secondary endpoints include: improvement in cardiac function, reduction in diuretic requirement; reduction in hospitalization stay; and improvement in symptoms.

[0103] As demonstrated by the data described above, the treatment of the present invention has been shown to have significant biological activity in humans and in a number of animal model systems, all of which involve Th1/TNF- $\alpha$  dependent inflammatory responses. As mentioned above, it is believed that the treatment down-regulates the pro-inflammatory Th1-type immune response, for example by increasing anti-inflammatory TH2 type cytokines, including IL-10. This would at least partially explain the ability of the treatment of the invention to produce therapeutic benefits in each of the three areas which characterize CHF.

[0104] Furthermore, there is evidence to suggest that the treatment of the invention is IL-10 dependent (**FIG. 9** and Shahid S. et al., *Journal of Investigative Dermatology*, 14, No. 4, 2000), bringing about an up-regulation of anti-inflammatory cytokines such as IL-10, and a down-regulation of TH-1 driven immune responses. It has also been proposed that IL-10 may be an important component of the cytokine network in CHF, as there appears to be a reduction in the level of IL-10 in relation to TNF- $\alpha$  in CHF (Yamaoka et al., *Jpn Circ J* 63: 951-956).

[0105] Although the invention has been described with reference to specific preferred embodiments, it will be appreciated that many variations may be made to the invention without departing from the spirit or scope thereof. All such modifications are intended to be included within the scope of the following claims.

1-26. (canceled)

27. A method of treating congestive heart failure (CHF) in a human patient suffering therefrom, comprising:

(a) treating an aliquot of the patient's blood ex vivo with a stressor comprising an oxidizing agent; and

(b) administering the aliquot of blood step (a) to the patient, wherein the aliquot has a volume sufficient to treat CHF in the patient.

28. The method of claim 27, wherein said stressor further comprises electromagnetic emissions and/or a temperature above or below body temperature.

29. The method of claim 28, wherein all of the stressors are simultaneously administered to the aliquot.

30. The method of claim 28, wherein any two of the stressors are simultaneously administered to the aliquot.

31. The method of claim 28, wherein the electromagnetic emission comprises ultraviolet light having one or more UV-C band wavelengths.

32. The method of claim 28, wherein the temperature to which the aliquot is cooled or heated is a temperature which does not result in substantial hemolysis of the blood in the aliquot.

33. The method of claim 32, wherein the mean temperature of the blood in the aliquot is in the range of from about  $0^\circ \text{C}$ . to about  $36.5^\circ \text{C}$ .

34. The method of claim 32, wherein the mean temperature of the blood in the aliquot is in the range of from about  $10^\circ \text{C}$ . to about  $30^\circ \text{C}$ .

35. The method of claim 32, wherein the temperature is in the range of from about  $40^\circ \text{C}$ . to about  $50^\circ \text{C}$ .

36. The method of claim 35, wherein the temperature is  $42.5 \pm 1^\circ \text{C}$ .

37. The method of claim 27, wherein the oxidizing agent is introduced into the blood aliquot in an amount which does not give rise to excessive levels of cell damage.

38. The method of claim 27, wherein the volume of the aliquot is up to about 400 ml.

39. The method of claim 38, wherein the volume of the aliquot is about 10 ml.

40. The method of claim 38, wherein the volume of the aliquot is about 2 ml.

41. The method of claim 27, wherein the aliquot is subjected to the stressor for a period of up to about 60 minutes.

42. The method of claim 41, wherein the aliquot is subjected to the stressor for a period of about 3 minutes.

43. The method of claim 27, wherein the blood is administered to the mammal by a method suitable for vaccination selected from the group consisting of intra-arterial injection, intramuscular injection, intravenous injection, subcutaneous injection, intraperitoneal injection, and oral, nasal or rectal administration.

44. A combination treatment for congestive heart failure (CHF) in a human patient suffering therefrom, the combination treatment including the administration to the patient of an aliquot of the patient's own blood which has been treated selected from the group ex vivo with a stressor comprising an oxidizing agent and selected from the group consisting of nitrates,  $\beta$ -blockers, ACE inhibitors, AT receptor blocking agents, aldosterone antagonists, calcium chan-

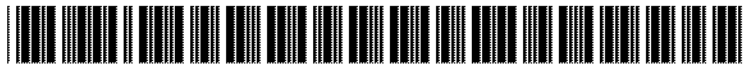
nel blocking agents, TNF blocking agents, suppressors of production of TNF- $\alpha$ , sodium and fluid restriction, diuretics and digitalis wherein the aliquot has a volume sufficient to treat CHF in the patient.

45. The combination treatment of claim 44, wherein the suppressors of production of TNF- $\alpha$  are selected from the group consisting of pentoxifyline, TACE inhibitors, amrinone, adenosine, thalidomide and dexamethasone.

46. A method of treating congestive heart failure (CHF) in a human patient suffering therefrom, comprising:

- a) treating an aliquot of the patient's blood ex vivo simultaneously, for a time up to 60 minutes, with a combination of stressors comprising (1) a mixture of ozone gas and medical grade oxygen, the ozone gas being contained in the mixture in a concentration of up to about 300  $\mu\text{g/ml}$ ; (2) ultraviolet light having one or more UV/C band wavelengths; and (3) temperature in the range of from about 37° C. to about 55° C.;
- b) administering the aliquot of the treated in step a) to the patient, wherein the aliquot has a volume sufficient to treat the CHF in the patient.

\* \* \* \* \*



US 20020090359A1

(19) **United States**

(12) **Patent Application Publication**

**Bolton et al.**

(10) **Pub. No.: US 2002/0090359 A1**

(43) **Pub. Date: Jul. 11, 2002**

(54) **TRANSFORMING GROWTH FACTOR  
REGULATION**

(76) Inventors: **Anthony E. Bolton**, Derbyshire (GB);  
**Arkady Mandel**, North York (CA);  
**Daniel Nathan Sauder**, Baltimore, MD  
(US)

Correspondence Address:

**Gerald F. Swiss**  
**BURNS, DOANE, SWECKER & MATHIS,**  
**L.L.P.**  
**P.O. Box 1404**  
**Alexandria, VA 22313-1404 (US)**

(21) Appl. No.: **10/002,630**

(22) Filed: **Dec. 5, 2001**

(30) **Foreign Application Priority Data**

Dec. 5, 2000 (CA) ..... 2,327,630

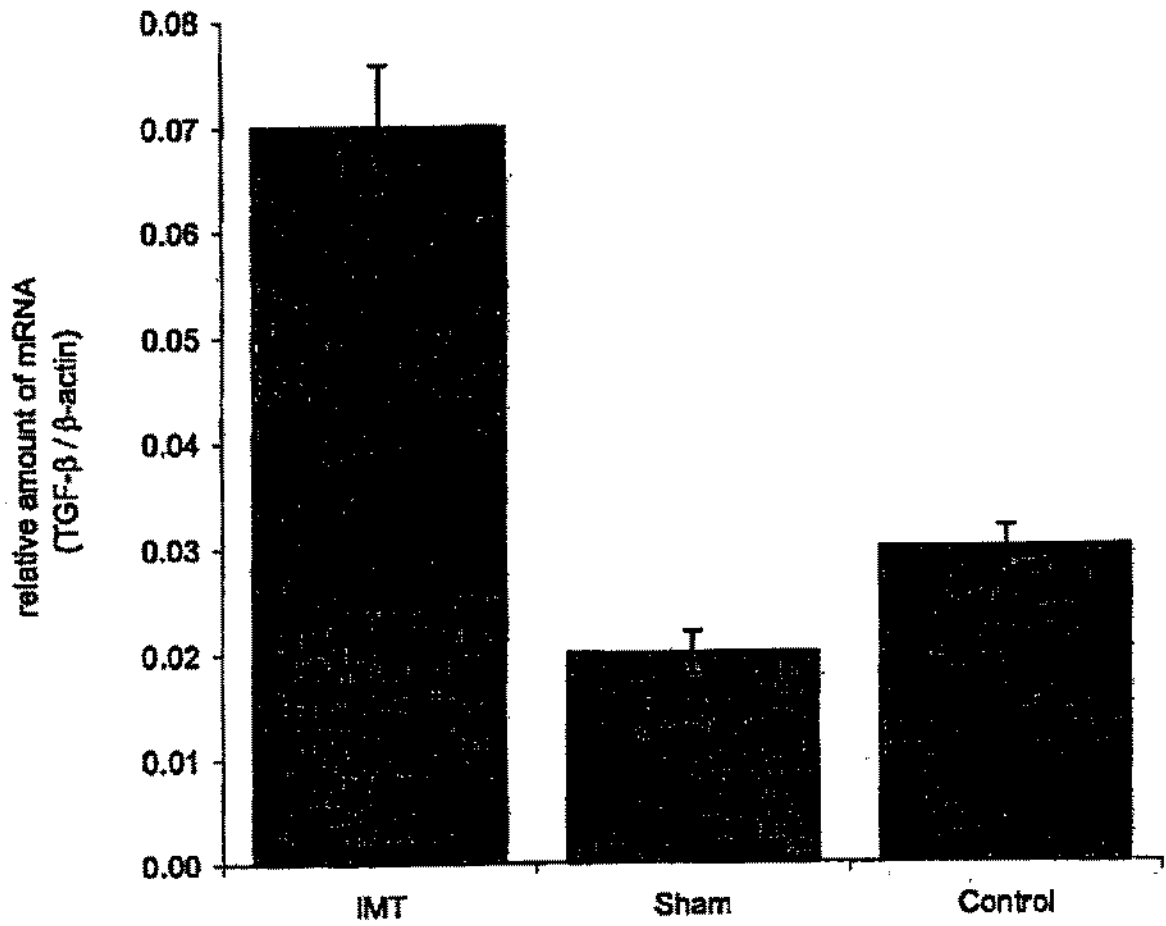
**Publication Classification**

(51) **Int. Cl.<sup>7</sup>** ..... **A61K 45/00; C12N 5/08**

(52) **U.S. Cl.** ..... **424/93.7; 435/372**

(57) **ABSTRACT**

The present invention relates to a process of increasing the expression of TGF- $\beta_3$  by cells in a mammalian patient, comprising administering to the patient an effective amount of stressed mammalian blood cells, said stressed cells having been extracorporeally subjected to at least one stressor selected from oxidative stress and ultraviolet radiation. The process of the present invention shows potential in the treatment of ulcers in mammalian patients.



**FIG. 1**



**A**

**B**

**FIG. 2**

## TRANSFORMING GROWTH FACTOR REGULATION

### CROSS-REFERENCE TO RELATED APPLICATIONS

[0001] This application claims priority from Canadian patent application serial number 2,327,630, filed Dec. 5, 2000, the disclosure of which is incorporated herein by reference.

### FIELD OF THE INVENTION

[0002] This invention relates to the treatment of biological cells and immune system modulation. More specifically, it relates to treating cells of the mammalian immune system to alter the cytokine profiles of certain types of constituent cells, and therapeutic applications of such treatments.

### BACKGROUND OF THE INVENTION

[0003] Transforming growth factor  $\beta_1$  ( $TGF-\beta_1$ ), is a cytokine secreted by various mammalian cells, including macrophages, dendritic cells and tissue cells. It appears to play a significant role in the operation of the immune system, by interaction with other component cells thereof alter its secretion. The mammalian immune system comprises lymphocytes (one type of white blood cell), the major components of which are B cells, which mature within the bone marrow, and T cells, which migrate from the bone marrow to mature in the thymus gland. B cells react to antigens to proliferate and differentiate into memory B cells and effector B cells which generate and express antibodies specific to the antigen, thereby removing the antigen from the host. T cells have T cell receptors which recognize antigen associated with MHC molecules on a cell, and as a result of this recognition differentiate into memory T cells and various types of effector T cells. The T cell population is made up of T-helper ( $T_H$ ) cells and T-cytotoxic ( $T_c$ ) cells, distinguished from one another by the presence of surface membrane glycoprotein CD4 on  $T_H$  cells and surface membrane glycoprotein CD8 on  $T_c$  cells. Activation of a  $T_H$  cell can cause it to secrete various growth factors (cytokines). Different types of  $T_H$  cells secrete different cytokines. Cytokines, including  $TGF-\beta_1$  play key roles in the immune response, including autoimmune responses, often by interacting with other cells to stimulate them into greater production of other cytokines or, conversely, to downregulate them to produce lesser amounts of other cytokines. They can also affect the differentiation and proliferation of cells such as T-cells, to change the population distribution of the various types of T-cells.

[0004] While the precise mechanism of action of  $TGF-\beta_1$  is not fully understood, it is known that  $TGF-\beta_1$  has various effects on the operation of the immune system. It appears to promote a switch in  $T_H$  cell type, from  $T_H1$  to  $T_H2$ , a switch which has benefits in alleviating or hindering the development of autoimmune diseases. It appears to have a role in angiogenesis, suggesting that its presence will have beneficial effects on rates of ulcer healing in the mammalian body.

[0005] A process or a medication which would promote the expression of the cytokine  $TGF-\beta_1$  in a mammalian body would accordingly offer significant benefits to mammalian patients suffering from one or more of a variety of different disorders. It also promotes the healing of ulcers, for example

venous ulcers, diabetic ulcers, gastric ulcers, duodenal ulcers, decubitus ulcers, etc. (Danno et.al., "Photodermatol Photoimmunol Photomed Dec. 17, 2001 (6):261-5; Zhou, L. J, et.al., Br J Dermatol 2000 September;143(3):506-12;). prolonged pressure and are common in situations where the patient remains in a fixed position for prolonged periods (e.g., long term bed confinement).

[0006] In particular, decubitus ulcer formation in nutrient deprived surface skin areas is facilitated by skin irritation due to moisture, friction, and shearing forces. Typically, decubitus ulcer formation is preceded by reddening of nutrient deprived skin which, with continued irritation, develops into the bedsore (i.e., a skin ulcer).

[0007] Diabetic ulcers are formed by deprivation of nutrients to the surface skin as a result of the diabetic condition including neuropathy, poor circulation in the patient, etc. In particular, diabetic ulcer formation in nutrient deprived surface skin areas is facilitated by skin irritation due to moisture, friction, and shearing forces. Typically, diabetic ulcer formation is preceded by reddening of nutrient deprived skin which, with continued irritation, develops into a skin ulcer.

[0008] Accordingly, it is an object of the present invention to provide a process whereby the expression of the cytokine  $TGF-\beta_1$  in a mammalian body may be promoted and increased.

[0009] It is a further object to provide a composition of matter for administration to a mammalian patient for promoting expression of the cytokine  $TGF-\beta_1$  in the patient's body.

[0010] It is a further object of the present invention to provide a process and composition useful in treating and accelerating the healing of ulcers in a mammalian patient.

### SUMMARY OF THE INVENTION

[0011] The present invention provides a process whereby expression of the cytokine  $TGF-\beta_1$  is promoted in a mammalian patient body. The process involves introducing blood cells into the patient which cells have been extracorporeally stressed by subjecting the blood cells to an oxidative stress and/or ultraviolet radiation. When these stressed blood cells are introduced to the patient, they appear to have the effect of promoting the expression of  $TGF-\beta_1$ , either by activating and upregulating one of the types of mammalian cells which naturally express it, or by increasing the relative population of such cells, or both. Whatever the precise mechanism of action, the result is a significant and measurable increase in  $TGF-\beta_1$  levels in the patient's system. Accordingly, the process of the invention is useful for the medical treatment of patients suffering from, prone to, or at risk of contracting a disorder associated with insufficient amounts of  $TGF-\beta_1$ . It also provides a process of accelerating the healing of wounds. Since increased levels of  $TGF-\beta_1$  are found in the dermis of human patients who have been given treatments according to the invention, the process is particularly indicated for the healing of skin ulcers, such as decubitus ulcers, diabetic ulcers and the like.

[0012] Thus according to the present invention, there is provided a process of increasing the expression of  $TGF-\beta_1$  by cells in a mammalian patient, which comprises administering to the patient an effective amount of stressed mam-



malian blood cells, said stressed cells having been extracorporeally subjected to at least one stressor selected from oxidative stress and ultraviolet radiation.

[0013] From another aspect, the present invention provides a composition of matter for administration to a mammalian patient to raise the levels of expressed TGF- $\beta_1$  in the patient's system, wherein said composition comprises stressed blood cells from the patient, the cells having been stressed by subjecting them extracorporeally to at least one stressor selected from oxidative stress and ultraviolet light.

#### BRIEF REFERENCE TO THE DRAWINGS

[0014] FIGS. 1 and 2 of the accompanying drawings are graphical presentations of results obtained according to the experiment of Example 1, described below.

#### DESCRIPTION OF THE PREFERRED EMBODIMENTS

[0015] The source of the stressed blood cells for use in the present invention is preferably the patient's own blood, i.e. an aliquot of autologous blood.

[0016] The terms "aliquot", "aliquot of blood" or similar terms used herein include whole blood; separated cellular fractions of the blood, including platelets; separated non-cellular fractions of the blood, including plasma; plasma components; and combinations thereof. Preferably, in human patients, the volume of the aliquot is up to about 400 ml, preferably from about 0.1 to about 100 ml, more preferably from about 1 to about 15 ml, even more preferably from about 8 to about 12 ml, and most preferably about 10 ml. The effect of the stressor or the combination of stressors is to modify the blood, and/or the cellular or non-cellular fractions thereof, contained in the aliquot. The modified aliquot is then re-introduced into the patient's body by any suitable method, most preferably intramuscular injection, but also including subcutaneous injection, intraperitoneal injection, intra-arterial injection, intravenous injection and oral administration, following which it causes an increase in the expression of TGF- $\beta_1$  by the patient.

[0017] According to a preferred process of the present invention, an aliquot of blood is extracted from a mammalian subject, preferably a human, and the aliquot of blood is treated ex vivo, simultaneously or sequentially, with the aforementioned stressors. The blood is then injected back into the same subject. Preferably a combination of both of the aforementioned stressors is used.

[0018] Preferably, the aliquot of blood is further subjected to mechanical stress. Such mechanical stress is suitably that applied to the aliquot of blood by extraction of the blood aliquot through a conventional blood extraction needle, or a substantially equivalent mechanical stress applied shortly before the other chosen stressors are applied to the blood aliquot. This mechanical stress may be supplemented by the mechanical stress exerted on the blood aliquot by bubbling gases through it, such as ozone/oxygen mixtures, as described below. Optionally also, a temperature stressor may be applied to the blood aliquot, simultaneously or sequentially with the other stressors, i.e. a temperature at, above or below body temperature.

[0019] The optionally applied temperature stressor either warms the aliquot being treated to a temperature above

normal body temperature or cools the aliquot below normal body temperature. The temperature is selected so that the temperature stressor does not cause excessive hemolysis in the blood contained in the aliquot and so that, when the treated aliquot is injected into a subject, the desired effect will be achieved, without development of significant adverse side effects. Preferably, the temperature stressor is applied so that the temperature of all or a part of the aliquot is up to about 55° C., and more preferably in the range of from about -5° C. to about 55° C.

[0020] In some preferred embodiments of the invention, the temperature of the aliquot is raised above normal body temperature, such that the mean temperature of the aliquot does not exceed a temperature of about 55° C., more preferably from about 40° C. to about 50° C., even more preferably from about 40° C. to about 44° C., and most preferably about 42.5±1° C.

[0021] In other preferred embodiments, the aliquot is cooled below normal body temperature such that the mean temperature of the aliquot is within the range of from about 4° C. to about 36.5° C., more preferably from about 10° C. to about 30° C., and even more preferably from about 15° C. to about 25° C.

[0022] The oxidative environment stressor can be the application to the aliquot of solid, liquid or gaseous oxidizing agents. Preferably, it involves exposing the aliquot to a mixture of medical grade oxygen and ozone gas, most preferably by applying to the aliquot medical grade oxygen gas having ozone as a component therein. The ozone content of the gas stream and the flow rate of the gas stream are preferably selected such that the amount of ozone introduced to the blood aliquot, either on its own or in combination with one of the other stressors, does not give rise to excessive levels of cell damage, and so that, when the treated aliquot is injected into a subject, the desired effect will be achieved, without development of significant adverse side effects. Suitably, the gas stream has an ozone content of up to about 300  $\mu\text{g}/\text{ml}$ , preferably up to about 100  $\mu\text{g}/\text{ml}$ , more preferably up to about 30  $\mu\text{g}/\text{ml}$ , even more preferably up to about 20  $\mu\text{g}/\text{ml}$ , particularly preferably from about 10  $\mu\text{g}/\text{ml}$  to about 20  $\mu\text{g}/\text{ml}$ , and most preferably about 14.5±1.0  $\mu\text{g}/\text{ml}$ . The gas stream is suitably supplied to the aliquot at a rate of up to about 2.0 litres/min, preferably up to about 0.5 litres/min, more preferably up to about 0.4 litres/min, even more preferably up to about 0.33 litres/min, and most preferably about 0.24±0.024 litres/min. The lower limit of the flow rate of the gas stream is preferably not lower than 0.01 litres/min, more preferably not lower than 0.1 litres/min, and even more preferably not lower than 0.2 litres/min, all rates at STP (0° C. and 1 atmosphere pressure).

[0023] The ultraviolet light stressor is suitably applied by irradiating the aliquot under treatment from a source of UV light, i.e. electromagnetic radiation of wavelength from about 180 nm to about 400 nm. Preferred UV sources are UV lamps emitting UV-C band wavelengths, i.e. at wavelengths shorter than about 280 nm. Ultraviolet light corresponding to standard UV-A (i.e., wavelengths from about 315 to about 400 nm) and UV-B (i.e., wavelengths from about 280 to about 315) sources can also be used. As in the case of the oxidative stressor, the UV dose should be selected, on its own or in combination with the other chosen stressor(s), so that excessive amounts of cell damage do not

occur, and so that, when the treated aliquot is injected into a subject, the desired effect will be achieved. For example, an appropriate dosage of such UV light, applied simultaneously with the aforementioned temperature and oxidative environment stressor, can be obtained from lamps with a power output of from about 10 to about 30 watts, arranged to surround the sample container holding the aliquot, each lamp providing an intensity, at a distance of 16 mm, of from about 5 to about 20 mW/cm<sup>2</sup>. Up to eight such lamps surrounding the sample bottle, with a combined output at 253.7 nm of 10 to 30 watts, operated at an intensity to deliver a total UV light energy at the surface of the blood of from about 0.025 to about 10 joules/cm<sup>2</sup>, and preferably from about 0.1 to about 3.0 joules/cm<sup>2</sup>, may advantageously be used. Such a treatment provides a modified blood aliquot which is ready for injection into the subject.

[0024] It is preferred to subject the aliquot to the oxidative environment stressor, the UV light stressor and the temperature stressor simultaneously, following the subjection of the aliquot to the mechanical stress, e.g. by extraction of the blood from the patient. Thus, the aliquot may be maintained at a predetermined temperature above or below body temperature while the oxygen/ozone gas mixture is applied thereto and while it is irradiated with ultraviolet light.

[0025] The time for which the aliquot is subjected to the stressors is normally within the time range of from about 0.5 minutes up to about 60 minutes. The time depends to some extent upon the chosen combination of stressors. When an UV light is used, the intensity of the UV light may affect the preferred time. The chosen temperature level may also affect the preferred time. When an oxidative environment in the form of a gaseous mixture of oxygen and ozone applied to the aliquot is chosen as one of the two stressors, the concentration of the oxidizing agent and the rate at which it is supplied to the aliquot may affect the preferred temperature. Some experimentation to establish optimum times may be necessary on the part of the operator, once the other stressor levels have been set. Under most stressor conditions, preferred times will be in the approximate range of from about 2 to about 12 minutes, more preferably from about 2 to about 5 minutes, most preferably about 3 minutes. The starting blood temperature, and the rate at which it can be warmed or cooled to a predetermined temperature, tends to vary from subject to subject. Warming is suitably by use of one or more infrared lamps placed adjacent to the aliquot container. Other methods of warming can also be adopted.

[0026] As noted, it is preferred to subject the aliquot of blood to a mechanical stressor, as well as the chosen stressor(s) discussed above. Extraction of the blood aliquot from the patient through an injection needle constitutes the most convenient way of obtaining the aliquot for further extracorporeal treatment, and this extraction procedure imparts a suitable mechanical stress to the blood aliquot. The mechanical stressor may be supplemented by subsequent processing, for example the additional mechanical shear stress caused by bubbling as the oxidative stressor is applied.

[0027] In the practice of the preferred process of the present invention, the blood aliquot may be treated with the heat, UV light and oxidative environment stressors using an apparatus of the type described in aforementioned U.S. Pat. No. 4,968,483 to Müller et al. The aliquot is placed in a suitable, sterile container, which is fitted into the machine. A

UV-permeable container is used and the UV lamps are switched on for a fixed period before the other stressor(s) is applied, to allow the output of the UV lamps to stabilize. When a temperature stressor is used in combination with UV light stressors, the UV lamps are typically on while the temperature of the aliquot is adjusted to the predetermined value, e.g. 42.5±1° C. Four UV lamps are suitably used by placing around the aliquot containing container.

[0028] In the preferred method of the invention, a mammalian patient standing to benefit from an increased expression of TGF-β<sub>1</sub> is given one or more courses of treatments, each course of treatment comprising the administration to the mammalian subject of one or more (e.g., one to six or one to twelve) aliquots of mammalian blood modified as discussed above.

[0029] For optimum effectiveness of the treatment, it is preferred that no more than one aliquot of modified blood be administered to the subject per day in one or more injection sites, and that the maximum rest period between any two consecutive aliquot administrations during the course of treatment should be no greater than about 21 days. As used herein, the term "rest period" is defined as the number of days between consecutive aliquots or consecutive courses of treatment on which no aliquots of modified blood are administered to the subject.

[0030] Therefore, except where aliquots are administered to the subject on consecutive days, a rest period of from 1 to 21 days is provided between any two aliquots during the course of treatment. Moreover, at least one of the rest periods during the course of treatment preferably has a length of about 3 to 15 days.

[0031] Although it may be sufficient to administer only one course of treatment as described above to the subject, it may be preferred in some circumstances to administer more than one course of treatment, or to follow the above-described course of treatment by periodic "booster" treatments, if necessary, to maintain the desired effects of the present invention. For example, it may be preferred to administer booster treatments at intervals of 1 to 4 months following the initial course of treatment, or to administer a second course of treatment to the subject following a rest period of several weeks or months.

[0032] The invention is further illustrated and described below with reference to Example 1, comprising animal studies conducted in an approved manner, and Example 2, a clinical trial on human patients. The examples are offered for purposes of illustrating the invention and should not be construed as a limitation.

#### EXAMPLE 1

[0033] Whole blood was obtained from Balb/c mice, by cardiac puncture through an injection needle, and treated with an anti-coagulant. An aliquot of this anti-coagulated blood was subjected to the process of a preferred embodiment of the invention, to obtain treated blood. The remainder was left untreated, for use in control experiments. Since the Balb/c mice used were genetically identical, the administration of the treated blood to others of the group is equivalent to administration of autologous blood.

[0034] To obtain treated blood, the selected aliquot, in a sterile, UV-transmissive container, was treated simulta-

nously with a gaseous oxygen/ozone mixture and ultraviolet light at elevated temperature using an apparatus as generally described in aforementioned U.S. Pat. No. 4,968, 483 Müller et al. Specifically, 12 ml of citrated blood was transferred to a sterile, low density polyethylene vessel (more specifically, a Vasogen VC7002 Blood Container) for *ex vivo* treatment with stressors according to the invention. Using an apparatus as described in the aforementioned Müller et al. patent (more specifically, a Vasogen VC7001 apparatus), the blood was heated to  $42.5 \pm 1^\circ$  C. and at that temperature irradiated with UV light at a wavelength of 253.7 nm, while oxygen/ozone gas mixture was bubbled through the blood to provide the oxidative environment and to facilitate exposure of the blood to UV. The constitution of the gas mixture was  $14.5 \pm 1.0$   $\mu$ g ozone/ml, with the remainder of the mixture comprising medical grade oxygen. The gas mixture was bubbled through the aliquot at a rate of  $240 \pm 24$  ml/min for a period of 3 minutes.

[0035] There were 4 groups of Balb/c mice. The first, control group A-1 received no treatment. The second, control group B-1, was treated with 50  $\mu$ l of physiological saline. The third, control group C-1, was sham treated with 50  $\mu$ l of blood which had been extracted, but not treated with the additional stressors. The fourth, test group D-1, was treated with 50  $\mu$ l of blood subjected to stressors as described above. Treatments, each involving injection of 50  $\mu$ l of the respective liquid into the gluteal muscle, started on day 1, and were repeated every day for a total of 6 days.

[0036] The experiment was run in parallel to the test for contact hypersensitivity resistance in the mice, as described in applicants co-pending international patent application PCT/CA00/00433 incorporated herein by reference, so that the various groups had been pre-sensitized with dinitrofluorobenzene (DNFB) and were subsequently challenged on one ear, 24 hours after the last injection, with DNFB as described therein, but this is not a factor in the tests demonstrating the present invention.

[0037] Each of the animals was sacrificed and the lymph nodes draining the ear that was challenged with DNFB were collected. The expression of the mRNA of the cytokine TGF- $\beta_1$  in the lymph tissue so obtained was analyzed using known RT-PCR techniques, essentially following the procedures described in Kondo et al., *J. Immunology*, Vol. 157:4822, 1996. The PCR products were determined by scanning of photonegatives using a laser densitometer, and the densitometric value of the TGF- $\beta_1$  was normalized to that of the housekeeping gene  $\beta$ -actin. The analyses indicated that animals which had received a course of injection of blood subjected to stressors as described had significantly increased concentrations of TGF- $\beta_1$  in the lymph node, as compared with controls and sham treated animals. The analyses were repeated three times, and the accompanying Figure illustrates the mean of these results.

#### EXAMPLE 2

[0038] A total of 20 human patients having moderate to severe psoriasis were randomized into a double blind, placebo controlled clinical trial. Two groups of 10 patients received 2 injections per week intramuscularly, into the gluteal muscle, of treated blood or saline, over a 3 week period. The therapy involved the collection of 10 ml of the patient's venous blood into 2 ml sodium citrate. The blood

was transferred to a sterile disposable low-density polyethylene vessel for *ex vivo* treatment as described in Example 1. Prior to muscular injection, 1 ml of Novocain was injected into the gluteal muscle as a local anesthetic.

[0039] Skin biopsies were taken at the end of the treatment, fixed in formalin and embedded in paraffin. Histological examination of skin biopsies of patients who had undergone treatment according to the invention was undertaken, by immunohistochemistry using a monoclonal antibody to TGF- $\beta_1$ . Increased production of TGF- $\beta_1$  in the dermis of patients treated according to the invention was seen in slides of tissue (FIG. 2a, microphotograph of the biopsied human skin sample after treatment to visualize TGF- $\beta_1$ ) based on increased density of staining in TGF- $\beta_1$  producing cells, compared to patients treated with saline (FIG. 2b). This result is indicative of the use of the process of the invention to upregulate TGF- $\beta_1$  and therefore in treating ulcers of the skin.

[0040] All references cited above are herein incorporated by reference in their entirety.

1. A process of increasing the expression of TGF- $\beta_1$  from cells in a mammalian patient, which comprises administering to the patient an effective amount of stressed mammalian blood cells, said stressed cells having been extracorporeally subjected to at least one stressor selected from oxidative stress and ultraviolet radiation, and thereby alleviating in the patient the symptoms of a disorder associated with TGF- $\beta_1$  deficiency.

2. A process of treating ulcers in a mammalian patient to accelerate the healing thereof, which comprises administering to an ulcer—suffering patient an effective amount of stressed mammalian blood cells, said stressed cells having been extracorporeally subjected to at least one stressor selected from oxidative stress and ultraviolet radiation, and thereby accelerating the healing of the patient's ulcer.

3. The process of claim 2 wherein the stressed blood cells originate from the same patient.

4. The process of claim 3 wherein the stressed cells have been subjected to both oxidative stress and ultraviolet radiation simultaneously.

5. The process of claim 4 wherein the stressed mammalian blood cells have been additionally extracorporeally subjected to heat stress simultaneously with the subjecting to both oxidative stress and ultraviolet radiation.

6. The process of claim 5 wherein the oxidative conditions comprise bubbling a gaseous mixture of medical grade oxygen and ozone through the blood, for a period of from about 0.5 minutes-60 minutes.

7. The process of claim 6 wherein the gaseous mixture has an ozone content of from about 0.1 to about 100  $\mu$ g/ml.

8. The process of claim 7 wherein the UV stressor is UV-C radiation.

9. The process of claim 8 wherein the temperature stressor is a temperature in the range of from about 40 to about 55 $^\circ$  C.

10. The process of claim 9 wherein the stressed mammalian blood cells comprise a volume of whole blood of from about 0.1 to about 400 mls.

11. A process of inhibiting ulcer formation in a mammalian patient at risk of said ulcer formation which comprises

administering to said patient an effective amount of stressed mammalian blood cells, said stressed cells having been extracorporeally subjected to at least one stressor selected from oxidative stress and ultraviolet radiation, and thereby accelerating the healing of the patient's ulcer.

12. The process of claim 11, wherein the stressed blood cells originate from the same patient.

13. The process of claim 11, wherein the stressed blood cells have been subjected to both oxidative stress and ultraviolet radiation simultaneously.

14. The process of claim 11, wherein the stressed mammalian blood cells have been additionally extracorporeally subjected to heat stress simultaneously with the subjection of both oxidative stress and ultraviolet radiation.

15. The process of claim 11, wherein the oxidative conditions comprise bubbling a gaseous mixture of medical

grade oxygen and ozone through the blood, for a period of from about 0.5 minutes to about 60 minutes.

16. The process of claim 15, wherein the gaseous mixture has an ozone content of from about 0.1 to about 100  $\mu\text{g}/\text{ml}$ .

17. The process of claim 11, wherein the UV stressor is UV-C radiation.

18. The process of claim 14, wherein the temperature stressor is a temperature in the range of from about 40 to about 55° C.

19. The process of claim 11, wherein the stressed mammalian blood cells comprise a volume of whole blood of from about 0.1 to about 400 mls.

\* \* \* \* \*



US006696092B2

**(12) United States Patent**  
**Bolton****(10) Patent No.: US 6,696,092 B2**  
**(45) Date of Patent: \*Feb. 24, 2004****(54) ENDOTHELIAL LINING EFFECTS AND TREATMENT OF VASOSPASTIC DISORDERS****(75) Inventor: Anthony E. Bolton, Tideswell (GB)****(73) Assignee: Vasogen Ireland Limited, Shannon (IE)****(\*) Notice:** This patent issued on a continued prosecution application filed under 37 CFR 1.53(d), and is subject to the twenty year patent term provisions of 35 U.S.C. 154(a)(2).

Subject to any disclaimer, the term of this patent is extended or adjusted under 35 U.S.C. 154(b) by 0 days.

This patent is subject to a terminal disclaimer.

**(21) Appl. No.: 09/267,773****(22) Filed: Mar. 15, 1999****(65) Prior Publication Data**

US 2002/0168420 A1 Nov. 14, 2002

**Related U.S. Application Data****(60)** Continuation-in-part of application No. 08/477,818, filed on Jun. 7, 1995, now Pat. No. 5,834,030, which is a continuation-in-part of application No. 07/941,326, filed on Sep. 4, 1992, now abandoned, which is a continuation-in-part of application No. 07/832,798, filed on Feb. 7, 1992, now abandoned, which is a division of application No. 08/765,225, filed as application No. PCT/CA96/00282 on May 3, 1996, now abandoned.**(30) Foreign Application Priority Data**May 5, 1995 (GB) ..... 9509197  
Nov. 2, 1995 (GB) ..... 9522475**(51) Int. Cl.<sup>7</sup> ..... A61K 33/00; A61K 35/14; A61K 41/00; A61L 2/10****(52) U.S. Cl. .... 424/613; 250/493.1; 424/529; 424/534; 435/2; 604/4.01****(58) Field of Search ..... 250/493.1; 422/24, 422/44, 45, 46; 424/613, 810, 529, 534; 514/929; 534/2; 604/4, 4.01; 435/2****(56) References Cited****U.S. PATENT DOCUMENTS**695,657 A 3/1902 Smith ..... 604/25  
3,715,430 A 2/1973 Ryan ..... 424/613  
4,632,980 A 12/1986 Zee et al. .... 530/380  
4,831,268 A 5/1989 Fisch et al. .... 250/432 R  
4,968,483 A \* 11/1990 Muller et al. .... 422/45  
4,983,637 A 1/1991 Herman ..... 514/7245,052,382 A 10/1991 Wainwright  
5,100,378 A 3/1992 Morgan, Jr.  
5,547,635 A 8/1996 Duthie, Jr. .... 422/24  
5,591,457 A \* 1/1997 Bolton ..... 424/613  
5,834,030 A \* 11/1998 Bolton ..... 424/613**FOREIGN PATENT DOCUMENTS**EP 582739 2/1994  
EP 624770 11/1994  
WO 93/15779 8/1993  
WO 95/20649 8/1995  
WO 93/15778 8/1998**OTHER PUBLICATIONS**

Harrison's Principles of Internal Medicine (1994, 13th Ed.), pp. 66-70, 1135-43.\*

Harrison's Principles of Internal Medicine (1983, 10th Ed.), pp. 1491-1498.\*

Miller et al., 'Is variant angina the coronary manifestation of a generalized vasospastic disorder?' (1981), New England Journal of Medicine, vol. 304, No. 13, pp. 763-766.\*

Drug Facts and Comparisons (2000, 54th Ed.), pp. 458-466, 849-61.\*

Ozon-Omed, "helping the body heal itself," Mueller Medical International Inc. (1990).

Abstract No. 1989:121366, "Preparation of oxidized blood fractions . . ." (1989).

Abstract No. 1995:283376, "Method for introducing oxygen into blood . . ." (1995).

Abstract No. 1998031574, "Effect of combined heat, ozonation and ultraviolet . . ." (1998).

Synder et al, "Biological Roles of Nitric Oxide," Scientific American, May 1992, pp. 68-77.

Bredt et al, "Cloned and expressed nitric oxide synthase . . ." Nature, vol. 351, pp. 714-718(1991).

"Secondary prevention of vascular disease by . . ." British Medical Journal, vol. 296, pp. 320-331 (1988).

German 1 068 428, Jentjens et al, Verfahren und Einrichtung zur Herstellung von oxygeniertem Blut (1960).

Goldman et al, Abstract of "Serum Soluble Interleukin 2 Receptor Levels in Erythrodermic . . .," (1993).

\* cited by examiner

Primary Examiner—Thurman K. Page

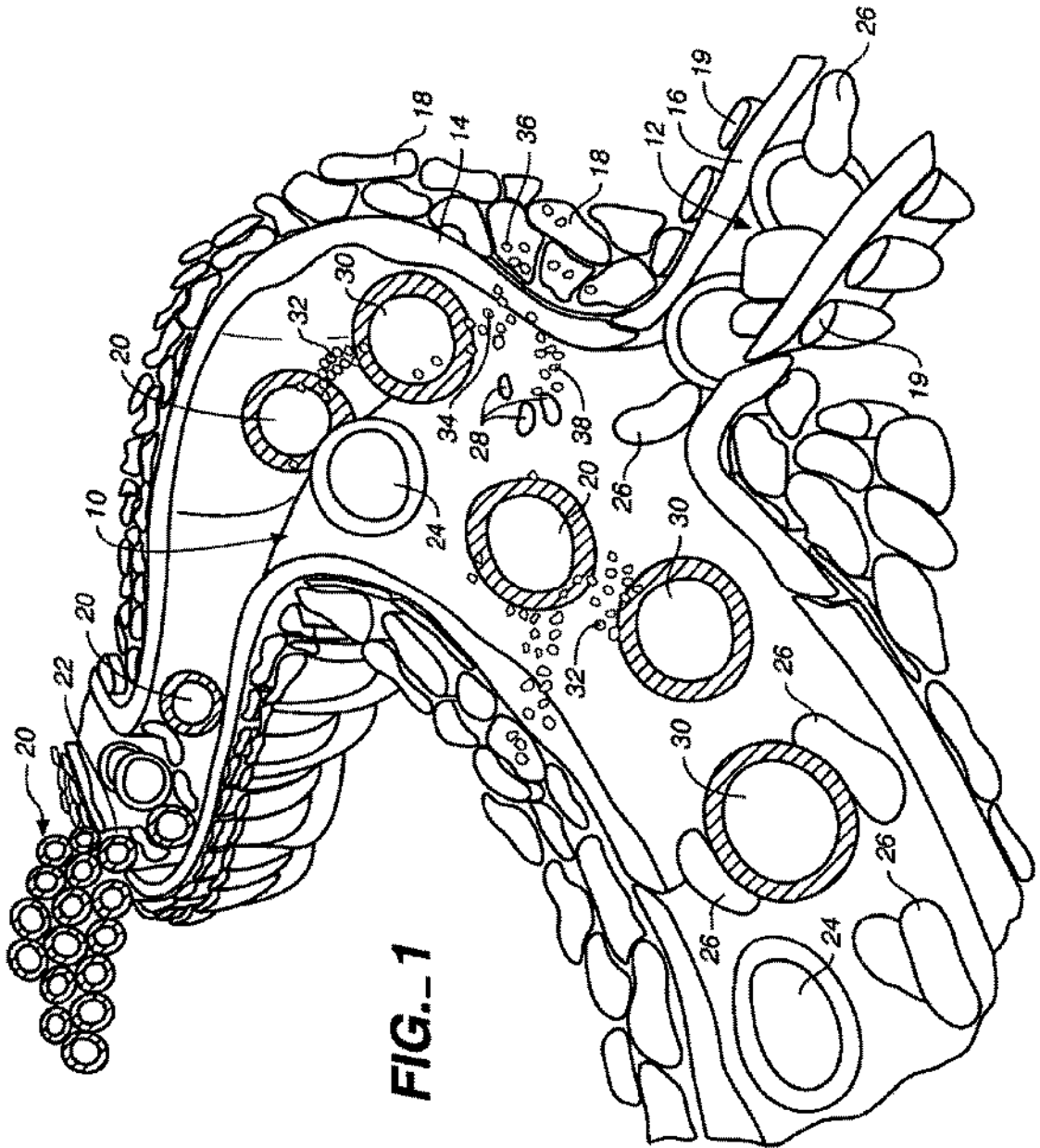
Assistant Examiner—Frank Choi

(74) Attorney, Agent, or Firm—Swiss Law Group

**(57) ABSTRACT**

Vasospastic disorders are treated by administering to the patient an aliquot of autologous blood which has been subjected simultaneously to heat, ultraviolet irradiation and oxidative environment so as to render the blood aliquot capable of generating in the patient's blood stream after administration a population of stimulated leukocytes having upregulated expression of CD25 cell surface markers, along with an enhancement of endothelial function in the patient.

**13 Claims, 2 Drawing Sheets**



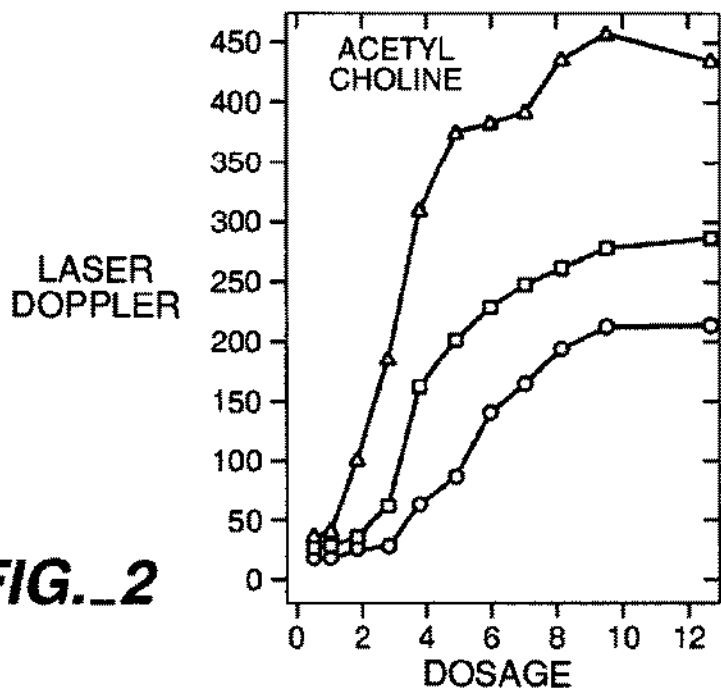


FIG.\_2

y: VISIT 1 = o, VISIT 11 = Δ, VISIT 12 = □

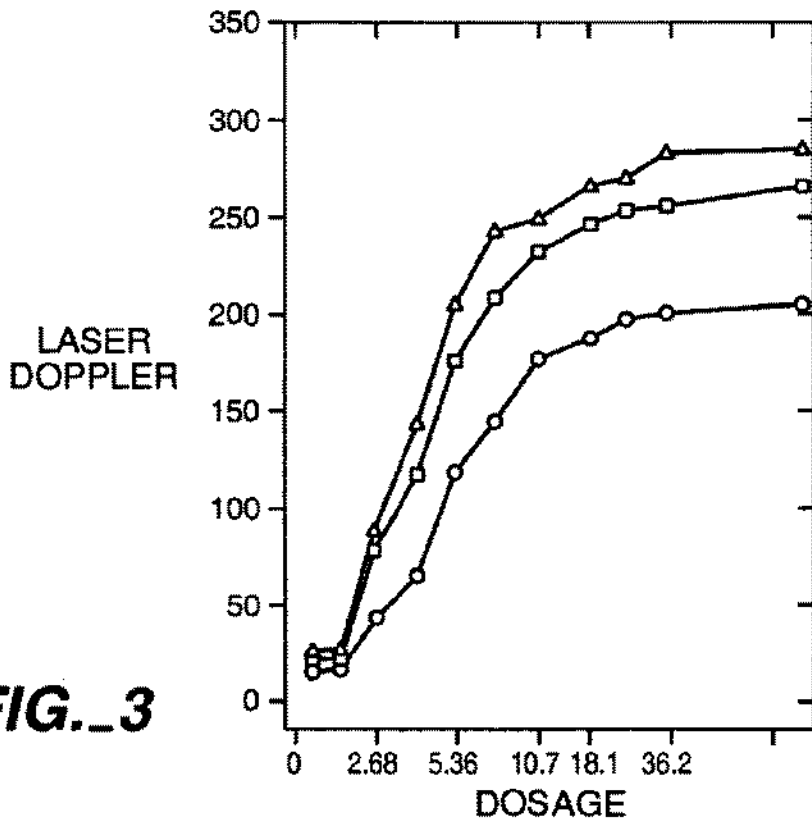


FIG.\_3

y: VISIT 1 = o, VISIT 11 = Δ, VISIT 12 = □

## ENDOTHELIAL LINING EFFECTS AND TREATMENT OF VASOSPASTIC DISORDERS

This Application is a continuation-in-part of U.S. application Ser. No. 08/477,818 filed Jun. 7, 1995 and issued Nov. 10, 1998 as U.S. Pat. No. 5,834,030, which is in turn a continuation-in-part of U.S. application Ser. No. 07/941,326 filed Sep. 4, 1992 (abandoned), which was a continuation-in-part of U.S. application Ser. No. 07/832,798 filed Feb. 7, 1992 (abandoned). It is also a division of U.S. application Ser. No. 08/765,225, filed Apr. 11, 1997 (abandoned), which is a §371 application of PCT/CA96/00282, filed May 3, 1996. The PCT application claims priority to Great Britain Patent Application Serial No. 9509197.1, filed May 5, 1995 and Great Britain Patent Application Serial No. 9522475.4, filed Nov. 2, 1995.

### FIELD OF THE INVENTION

This invention relates to treatment of blood cells, and the use of treated, modified blood cells in connection with certain abnormal mammalian physical conditions and disease states. More specifically, it relates to modified mammalian blood and blood cells, methods of achieving the modified mammalian blood and blood cells, and the treatment, among other disorders, of vascular disorders associated with deficient endothelial function, such as vasospastic disorders, in a mammalian patient by administration to the patient of such modified blood and blood cells.

### BACKGROUND OF THE INVENTION

The control and regulation of blood flow through the cardiovascular system of a mammal is well recognized to be of importance in connection with cardiovascular disorders such as atherosclerosis, peripheral vascular disease and many other circulatory disorders. There is an emerging body of literature which indicates that the endothelium plays a major role in the regulation of blood flow through the cardiovascular system. The endothelium is a cellular structure which lines the blood vessels, communicating with the smooth muscle layer of the blood vessel walls. Contraction of this muscle layer causes the blood vessels to constrict (vasoconstriction), and relaxation of this muscle layer causes the blood vessels to expand (vasodilation). A normally functioning endothelium effectively controls the smooth muscles of the vessel wall, by secreting vasodilators or vasoconstrictors which diffuse or are carried to the muscle fibres to cause the muscle fibres either to relax or to contract. One such vasodilator secreted by the endothelium is commonly referred to as "endothelium derived relaxing factor" (EDRF), but has recently been established to be nitric oxide, a form thereof or a closely related compound. In addition to regulating blood flow, nitric oxide is recognized as having many other actions within the body, including neurotransmission, a smooth muscle controlling function within the gastrointestinal tract, both natural and drug induced analgesia, a role in impotence and in tumour toxicity.

It is believed that defective functioning of the endothelium of a patient is an underlying factor in many cardiovascular diseases observed in mammalian patients. For example, a patient with atherosclerosis has excessive quantities of lipid underlying the endothelium, including oxidized low density lipoprotein (containing cholesterol) which is believed to interfere with the proper functioning of the endothelial cells.

### SUMMARY OF THE INVENTION

The present invention is based upon the discovery that one can extracorporeally subject an aliquot of a mammalian

patient's blood, or the separated cellular fractions of the blood, or mixtures of the separated cells, including platelets, to certain stressors and create in the aliquot modified leukocytes. On re-introduction of the aliquot to the patient's body by various routes including intra-muscular injection, the modified leukocytes have certain beneficial effects. One of these effects is stimulation of the activity of a functionally deficient endothelium.

The modified leukocytes of the present invention can be obtained by subjecting the aliquot of the patient's blood, or the separated cellular fractions of the blood, or mixtures of the separated cells, including platelets, to stressors selected from heat, ultraviolet radiation and oxidative environments such as treatment with ozone/oxygen mixtures, or any combination of such stressors, simultaneously or sequentially.

Thus, according to the present invention, *ex vivo* treatment of the blood, or the separated cellular fractions of the blood, or mixtures of the separated cells, including platelets, promotes the subsequent development of modified leukocytes, which are different from the untreated cells that are found in the peripheral blood of normal individuals and patients before receiving this treatment, in that they cause an *in vivo* effect.

The effects of the modified leukocytes of the present invention, when re-injected into the mammalian patient's body, are several in number. Firstly, there is an effect on other leukocytes or their progenitors which have not been modified by the externally applied stressors, as a result of cell-to-cell communication, a widely recognised phenomenon among cells of the immune system. The result of injecting the blood subjected to stressors outside the body is the upregulation of specific cell surface markers such as HLA-DR and CD25 on other, non-treated leukocytes in the peripheral blood, circulating in the patient. This is indicative of an enhanced immune system. It appears that the treated leukocytes release cytokines (intercellular messenger peptides and proteins), or stimulate leukocytes of the recipient to do so, initiating a cascade phenomenon which affects a number of the quiescent leukocytes in the peripheral blood and causes them to become stimulated. This apparently leads to improved blood flow at sites in the body far removed from the site of injection of the treated leukocytes.

Secondly, the stimulated leukocytes present in the blood circulation, perhaps through the intermediary of the same or similar cytokines and probably after physical contact or binding to the endothelium via cell adhesion molecules, act upon the endothelium, either directly or indirectly, to increase the endothelial vasodilator function probably by increasing the production and/or action of vasodilators such as nitric oxide, prostacyclin and/or by inhibiting the production and/or action of vasoconstrictors, so as to increase blood flow. This can be manifested either as a restoration of the function of a portion of the endothelium which has become defective, the portion being close to or remote from the site of injection. Such restoration of function may occur through repair of deficient cells or an enhanced rate of replacement of damaged cells. It can also be manifested as an overall improvement in endothelial function. This increased blood flow resulting from increased endothelial vasodilator function, and the consequent increase in oxygenation of tissues, is indicative of use of the process of the present invention in treatment of patients with vascular disease including those with advanced peripheral vascular disease, those with chronic varicose ulcers, and those at risk of developing gangrene which frequently results in amputation. In general, the leukocytes according to the present



invention are indicated for use in treating any type of vascular disease either involving partial or complete blood vessel occlusion leading to restricted blood flow or dysfunction of the mechanisms required to permit adequate vasodilation such that tissues including those of the central nervous system, heart, lungs, gastrointestinal tract, liver, kidneys, placenta or extremities would be acutely or chronically affected in terms of structure or function.

#### BRIEF DESCRIPTION OF THE DRAWINGS

FIG. 1 is a diagrammatic illustration of the believed mode of action of the injected leukocytes according to the present invention, in the vascular system.

FIGS. 2 and 3 are graphical presentations of the results of clinical tests of the use of the present as described in Example 3 below.

#### DESCRIPTION OF THE PREFERRED EMBODIMENTS

With reference to the FIG. 1, there is diagrammatically illustrated an arteriole 10. An arteriole is a blood vessel forming part of the mammalian vascular system, of a size smaller than an artery, and which receives circulating blood from an artery, fed from the heart. Arterioles gradually decrease in size, in the downstream direction. A metarteriole 12, which is a smaller terminal branch of the arteriole 10, is shown branching off the arteriole 10. Metarterioles such as 12 lead to capillaries which are the site of nutrient and gaseous exchange between the blood and the tissues, with oxygen diffusing from the blood to the tissues and carbon dioxide diffusing from the tissues to the blood. The arteriole 10 is lined with a cellular layer of endothelium 14. Surrounding the exterior of the arteriolar endothelium 14 is a layer of smooth muscle 18, which can contract or expand to cause alterations in the size of the arteriole 10, causing either vasodilation to increase the amount of blood flow therethrough or vasoconstriction to reduce the amount of blood flow therethrough. The metarteriole 12 is similarly lined with endothelium 16 and has a single layer of smooth muscle 19, functioning similarly.

As in the case of all the other blood vessels in the body, of all the various sizes, capillaries are lined with endothelium. However, there is no smooth muscle layer associated with the capillaries.

According to the preferred process of the present invention, an aliquot of blood, or the separated cellular fractions of the blood, or mixtures of the separated cells, including platelets, is extracted from the patient and treated with certain stressors, described in more detail below. The effect of the stressors is to modify leukocytes in the aliquot. These modified leukocytes 20, along with the rest of the aliquot, are re-injected intramuscularly and, after a period within the muscle, of uncertain and probably variable duration, they probably gain entry to the general circulation by passing through the blood vessel wall, where mixing with the blood occurs. Downstream from the point of entry 22, therefore, the blood will contain modified leukocytes 20 in addition to unmodified leukocytes 24, red blood cells 26 and platelets 28, as well as other components.

The injection of modified leukocytes 20 appears to have a number of unexpected effects on the arteriole 10 and on the blood flowing through it. One effect is the stimulation of quiescent leukocytes 24, which have not been subjected to the stressors outside the body, to transform into stimulated leukocytes 30. This activation process may occur in sites other than the blood vessels, for example in immune system

organs such as lymph nodes, spleen or bone marrow, and may involve leukocyte progenitors in addition to or alternatively to mature leukocytes. Thus a cascade mechanism is set in motion. This is believed to be effected by the secretion of certain cytokines 32, the precise nature of which is uncertain, either from the modified leukocytes 20 themselves or by the stimulation of endogenous leukocytes 30 by direct cell—cell interaction. These mechanisms serve to effect stimulation of previously quiescent leukocytes or progenitors to create the stimulated leukocytes 30. The stimulated leukocytes 30 probably adhere to the damaged endothelial cells via cell adhesion molecules such as ICAM-1 expressed on the endothelial cells interacting with activated LPA-1 expressed on certain activated leukocytes. Other cytokines 34, perhaps originating from these adherent leukocytes and which may in fact be the same as or different from the cytokines 32, contact the endothelium 14, and cause it to secrete vasodilators 36 which have the effect of relaxing the smooth muscle 18 to cause a degree of vasodilation. Other secretions 38 released from the endothelium 14 by the cytokines 34, which may or may not be the same substances or mixture of substances as the vasodilators 36, contact the platelets 28, and have the effect of inhibiting their ability to aggregate. Whilst the accompanying figure diagrammatically illustrates endothelial effects at the endothelium of an arteriole of the vascular system, it appears that the process of the invention has a similar effect on endothelial cells at all levels of the vascular tree.

It is believed that one of the components of the vasodilators 36, and one of the components of the secretions 38, is endothelium derived relaxing factor EDRF, probably nitric oxide or closely related substances, and a second component is prostacyclin. Alternative or additional sources of nitric oxide and/or other vasodilators resulting from a treatment according to the present invention may be stimulated leukocytes present in the circulation or stimulated platelets present in the circulation.

The stressors to which the leukocytes are subjected *ex vivo* according to the invention are selected from temperature stress (blood temperatures above or below body temperature), an oxidative environment and ultraviolet radiation, individually or in any combination, simultaneously or successively. The leukocytes are subjected to the stressors as a part of an aliquot of mammalian blood or the separated cellular fractions of the blood, or mixtures of the separated cells, including platelets, extracted from the patient to whom the aliquot is to be injected following subjection to the stressors. Suitably the aliquot has a volume of from about 0.1–100 mls, preferably 5–15 mls, a most preferred, typical aliquot being 10 mls in volume.

It is preferred, according to the invention, to apply all three of the aforementioned stressors simultaneously to the aliquot under treatment, in order to ensure the appropriate modification of a sufficient number of leukocytes. Care must be taken not to utilised an excessive level of the stressors, to the extent that the cells or any parts of them become irreparably damaged, or that the cell membrane is caused to be disrupted.

The temperature stressor, when it is applied, must keep the aliquot liquid, and should not heat it above about 55° C., for fear of damaging the cells. Preferably the temperature stressor warms the aliquot being treated to a temperature above normal body temperature, i.e., to about 37–55° C., and most preferably from about 40–50° C.

The oxidative environment stressor can be the application to the aliquot of liquid or gaseous oxidizing agents. Prefer-

ably it involves exposing the aliquot to a mixture of medical grade oxygen and ozone gas, most preferably by bubbling through the aliquot, at the aforementioned temperature range, a stream of medical grade oxygen gas having ozone as a minor component therein. Suitably the gas stream has an ozone content of from about 1.0–100  $\mu\text{g}/\text{ml}$ , preferably 3–70  $\mu\text{g}/\text{ml}$ , and most preferably about 5–50  $\mu\text{g}/\text{ml}$ . The gas stream is supplied to the aliquot at a rate of from about 0.01–2.0 liters/minute, preferably at about 0.05–5.0 liters per minute and most preferably at about 0.06 liters per minute (STP).

The ultraviolet radiation stressor is suitably applied by irradiating the aliquot under treatment from an appropriate source of UV radiation while the aliquot is maintained at the aforementioned temperature and while the oxygen/ozone gaseous mixture is being bubbled through the aliquot. Appropriate UV sources are UV lamps emitting in the C-band wavelengths, i.e. at wavelengths shorter than about 280 nm. Ultraviolet radiation corresponding to standard UV-A and UV-B sources can also be used. Emissions at wavelength 253.7 nm are particularly suitable. An appropriate dosage of such UV radiation, applied simultaneously with the aforementioned temperature and oxidative environment stressors, is obtained from lamps with a power output of from about 15 to about 25 watts, at the chosen UV wavelength, arranged to surround the sample container holding the aliquot, each lamp providing an intensity, at a distance of 1 meter, of from about 45–65 mW/sq.cm. Up to eight such lamps surrounding the sample bottle, with a combined output at 253.7 nm of 15–25 watts, operated at an intensity to deliver a total UV light energy at the surface of the blood of about 0.025–10, preferably about 0.1–0.5 joules/cm<sup>2</sup>, may advantageously be used. Such a treatment provides an aliquot which contains stimulated leukocytes according to the invention in appropriate amounts to cause the effects outlined above ready for re-injection into the patient.

The time for which the aliquot is subjected to the stressors is normally within the time range of from about 0.5–60 minutes. This depends to some extent upon the chosen intensity of the UV irradiation, the temperature and the concentration of and rate at which the oxidizing agent is supplied to the aliquot. The more severe the stressors applied to the aliquot, generally the shorter time for which they need to be applied. Some experimentation to establish optimum times may be necessary on the part of the operator, once the other stressor levels have been set. Under most stressor conditions, preferred times will be in the approximate range 2–5 minutes, and normally around 3 minutes. The starting blood temperature, and the rate at which it can be warmed or cooled to a predetermined temperature, tends to vary from patient to patient.

In the practice of the preferred process of the present invention, the blood aliquot (or the separated cellular fractions of the blood, or mixtures of the separated cells, including platelets, these various leukocyte-containing combinations, along with whole blood, being referred to collectively throughout as the "aliquot") may be treated with the stressors using an apparatus of the type described in U.S. Pat. No. 4,968,483 Mueller. The aliquot is placed in a suitable, sterile, radiation-transmissive container, which is then fitted into the machine. The temperature of the aliquot is adjusted to the predetermined value, e.g. 42.5° C., and the UV lamps are switched on for a fixed period before the gas flow is applied to the aliquot providing the oxidative stress, to allow the output of the UV lamps to stabilize. Then the oxygen/ozone gas mixture, of known composition and con-

trolled flow rate, is applied to the aliquot, for the predetermined duration of 0.5–60 minutes, preferably 2–5 minutes and most preferably about 3 minutes as discussed above, so that the aliquot experiences all three stressors simultaneously. In this way, appropriately modified leukocytes according to the present invention are generated in numbers sufficient to achieve the desired effects.

Another characteristic of the modified leukocytes of the present invention is their ability to generate in the bloodstream of the patient, after re-injection, stimulated leukocytes having an increase in activation markers, for example CD 25 (IL-2 receptor), Ber-Mac 3 and HLA-DR (T-cell and monocyte activation). These cell surface markers are surface proteins, the quantities of which are increased by injecting the modified leukocytes prepared using the stressors of the preferred process of the present invention i.e. temperature, an oxidising environment, and UV radiation. They can be quantified by staining techniques and use of conventional monoclonal antibody techniques.

The proper functioning, or lack thereof, of the endothelium of a patient, at a particular location, can be tested by using a method which involves the iontophoretic introduction of acetylcholine through the skin, and measurement of its effect on superficial blood at the chosen location.

Acetylcholine added to a blood vessel which has intact, properly functioning endothelium, stimulates the production and secretion of nitric oxide by the endothelium. The nitric oxide so produced acts as a vasodilator and causes the smooth muscle cells to relax. The effect of such vasodilation can be quantitated by measuring the flow of blood in the vessel, e.g. by laser Doppler flowmetry. If, however, the endothelium of the patient has a major functional defect, the acetylcholine may act directly on the smooth muscles themselves, and cause them to contract, resulting in vasoconstriction, the opposite of the effect observed when the patient's endothelium is functioning normally.

Endothelial function may accordingly be examined clinically as follows. Acetylcholine is applied to the skin of the patient and a small electric current is applied across the skin between two adjacent electrodes, one positively and one negatively charged (iontophoresis). Acetylcholine, being a charged molecule, passes through the skin with the current to the superficial blood vessels immediately below the skin surface. At this site, acetylcholine acts on the endothelial cells of the blood vessels, stimulating them to produce EDRF (e.g. nitric oxide), resulting in vasodilation (endothelial dependent vasodilation) and an increase in blood flow, which is measured by laser Doppler flowmetry, for example. This technique is known, in general terms—see, for example, Chowieńczyk et.al., "Impaired endothelium-dependent vasodilation of forearm resistance vessels in hypercholesterolaemia", *The Lancet*, Vol. 340, Dec. 12, 1992, p.1430.

A specific preferred application for the present invention is in treatment for, or at least alleviation of the symptoms of, the vasospastic type diseases as exemplified by Raynaud's Phenomenon and other vasospastic disorders such as migraine, cluster headache and syndrome X. Raynaud's Phenomenon is a state in which the fingers and/or toes undergo a series of colour changes, white (vasospasm), then blue (capillary stagnation) then red (arterial dilation), lasting a variable time and for a variable frequency, and with or without pain. Raynaud's Disease or primary Raynaud's is the term for Raynaud's Phenomenon in the absence of any other detectable disease. Raynaud's syndrome, or secondary Raynaud's, is the term for Raynaud's Phenomenon associated with other diseases.

Whilst Raynaud's is not in itself life threatening, it may lead to the onset of other pathological conditions, and to-date there has been no effective cure put into general practice for it. A patient suffering from Raynaud's must simply endure the associated pain and discomfort. In a small proportion of cases, the ischemia of the digits resulting from extreme vasospasm may lead to skin ulceration and gangrene, which may result in amputation. Raynaud's Phenomenon can affect patients at substantially any age, and affects about four times as many women as men.

Following one or more treatments according to the procedure of the invention, spaced at appropriate intervals, dramatic alleviation of the symptoms of the Raynaud's phenomenon is experienced, in the cases of all of the patients on which the treatment has so far been employed. Iontophoretic measurements conducted on the blood flow of the subject patients, before and after undergoing the treatment according to the invention, have shown an enhancement of the endothelial performance in the patients of concern, and an alleviation of the Raynaud's phenomenon symptoms.

Thus from another aspect, the present invention provides an aliquot of autologous human blood for administration to a patient to alleviate Raynaud's phenomenon in the patient, the aliquot of autologous blood having been subjected, *in vitro*, to at least one stressor selected from heat, UV radiation and ozone/oxygen mixture to stimulate leucocytes therein, to the extent that, upon re-injection into the patient, a significant enhancement of endothelial function to cause vasodilation is experienced.

The invention is further illustrated and described with reference to the following specific examples.

#### EXAMPLE 1

A patient suffering from primary Raynaud's disease was given a course of treatment under carefully controlled clinical conditions, according to the present invention. Each treatment administered to the patient involved removing a small aliquot of the patient's blood, exposing it to stressors *ex vivo* and re-introducing the treated blood aliquot to the patient as described in the invention. The course of treatment administered to the patient comprised ten such individual treatments, one administered each day over a period of about two weeks. Raynaud's disease is a disorder associated with peripheral vasospasm and inadequate blood flow at the extremities of the patient's body, such as the fingers, characterized initially by marked pallor of the fingers on exposure to cold, often followed by a subsequent phase of cyanosis (bluish colour) and a slowing of the restoration of blood flow after cold exposure ceases.

The subject of this experiment was a female patient of about 24 years of age who had suffered from primary Raynaud's disease for at least 10 years, with the fingers of both hands being severely affected. Prior to commencing the course of treatments according to the invention, the blood flow in the superficial blood vessels of the fingers was measured by laser Doppler flowmetry and photoplethysmography in response to mild cold and warm stresses of the hand. The skin surface temperatures of the fingers were also measured by a thermographic technique in response to warm and cold stress of the hands. The blood flow in response to iontophoretic introduction of acetyl choline was measured by laser Doppler flowmetry, prior to commencing the course of treatments.

10 mls of the patient's blood were extracted from an arm vein, anticoagulated and collected in a sterile sample bottle. This sample was subjected to heat—UV radiation—oxidising (oxygen/ozone mixture) stressors according to the procedure of the invention, in an apparatus generally as

illustrated in aforementioned U.S. Pat. No. 4,968,483 Mueller. The blood sample was heated to 42.5° C. and UV irradiation of wavelength 253.7 was applied to it. Upon reaching the required temperature (42.5° C.), a gaseous mixture of medical grade oxygen with an ozone content of 12.5 micrograms per ml, at a gas flow rate of about 60 ml/min was bubbled through the sample for 3 min.

After the *ex vivo* treatment of the blood sample had been completed according to the procedure of the invention, the sample was re-injected into the gluteal muscle of the patient. Shortly after completion of the course of ten treatments over a period of two weeks, the patient reported an alleviation of her symptoms of Raynaud's disease. This state of improvement persisted for at least two months after the completion of the course of treatment.

The skin temperature and the blood flow measurements in response to warm and cold stress and the blood flow after iontophoretic introduction of acetyl choline were repeated after the course of treatment according to the invention. The responses to warm and cold stress were reflective of a more normal response after treatment than before. The blood flow response to acetyl choline after treatment was increased, indicating an increase in the ability of the endothelium to produce vasodilators following the treatment. All the measurements showed evidence of an increase in peripheral blood flow following the treatment along with the alleviation of the symptoms of Raynaud's disease.

Generation in the blood of treated patients of increased levels of prostacyclin is also an effect resulting from the *ex vivo* stressing of the blood cells in the manner described, according to the present invention. Amelioration of the effects of a defective endothelium with its consequent alleviation of abnormal conditions associated therewith, such as vasospastic disorders as exemplified by Raynaud's disease, is just one of the several beneficial effects likely to be derived by correct medical use of the processes, techniques and modified leukocytes forming aspects of the present invention.

#### EXAMPLE 2

Four patients, including the subject of Example 1, human females ranging in age from 15 to 84 years, and all suffering from primary Raynaud's phenomenon, were subjected to a course of treatment according to the present invention. Treatment was given by skilled, qualified personnel, in a medical hospital facility on an out-patient basis.

Each treatment administered to a patient involved removing a 10 ml aliquot of the patient's blood, into an apparatus as generally illustrated in aforementioned U.S. Pat. No. 4,968,483 Mueller, heating the sample to 42.5° C. and exposing it to UV irradiation at wavelength 253.7 nm. Upon reaching the required temperature (42.5° C.), a gaseous mixture of medical grade oxygen with an ozone content of 12.5 micrograms per ml, at a gas flow rate of about 60 ml/min was bubbled through the sample for 3 minutes.

After the *ex vivo* treatment of the blood sample had been completed in this manner, the sample was re-injected into the respective patient via the gluteal muscle. Each patient underwent a course of 10 such treatments over a period of 2-4 weeks, the individual treatments being spaced apart by about 1-3 days.

Subjectively, every patient reported a very significant alleviation of her Raynaud's symptoms, after completion of the course of treatments. This state of improvement persisted for at least two months after the completion of the course of treatment. In the case of the 14 year old female patient, she

exhibited as part of the Raynaud's symptoms initially, small, slow healing ulcerations of the feet, around the toes. All of these had healed by the end of the course of 10 treatments. The 84 year old patient initially had noticeably disfigured fingernails at the fingernail beds, resulting from reduced nutrition and reduced oxygenation caused by lack of circulation of blood thereto. At the end of the course of treatment, new growth of nails from the nail bed had started and was clearly visible.

EXAMPLE 3

In the case of each patient, objective measurements of blood flow, before and after the course of treatments, were made by the iontophoretic technique using acetylcholine previously described. The iontophoretic applications and measurements were made on the patients' forearms. The initial measurements on each patient were taken immediately before the first treatment (i.e. during visit 1). The subsequent measurements were all taken one day after the completion of the course of ten treatments (i.e. during visit 11) and again on a follow-up basis two or three weeks later (i.e. during visit 12). One of the four patients was given a second, subsequent course of five further treatments. Blood flow was measured by laser Doppler flowmetry, to give an indication of vasodilation.

For each measurement, a reservoir containing acetylcholine was mounted on the patient's arm with the acetylcholine in contact with the patient's skin. Electrodes were inserted into the reservoir, so that a current of known but variable magnitude could be applied to the reservoir to exert an iontophoretic effect. The dose of acetylcholine applied to the skin is a function of the time of acetylcholine-skin contact and the voltage applied between the electrodes, thereby giving a dose in arbitrary units.

FIG. 2 of the accompanying drawings presents a graph of observed laser Doppler flow of blood, against dosage in arbitrary units determined as above, for one representative patient. The duration of the iontophoresis was arbitrarily divided into various equal time intervals or epochs. The mean flow at each epoch is plotted against time, with the mean plotted at the mid time point of each epoch. The curve denoted by circles is that obtained from testing conducted before the first treatment, i.e. on the patient's first visit. As shown, blood flow increases in a generally sigmoidal fashion as the acetyl choline dosage (function of contact time and applied iontophoretic voltage) increases. The curve denoted by triangles is that obtained in a similar manner, on the patient's 11th visit, one day after the conclusion of the course of ten treatments. The curve denoted by squares is that obtained on the patient's 12th visit, twenty eight days after the 11th visit. Effectively, these are dose response curves. A significant increase in blood flow in response to

acetyl-choline, indicative of an enhanced endothelial function, after the course of treatment, is evident from these curves.

The shapes of the respective curves indicate that increasing doses of acetylcholine cause increasing levels of blood flow, up to a plateau level in each case. This is explained by the fact that the acetylcholine is stimulating the production and secretion of the vasodilator nitric oxide (EDRF) by the endothelium, and that the endothelium is acting normally.

All four of the patients treated showed essentially similar results, those presented on FIG. 2 being representative, and from a single patient. FIG. 3 of the accompanying drawings shows similar curves to FIG. 2, but derived from the means of the measured blood flows of all four of the patients. As in the case of the FIG. 2 curves from the one patient, the curves denoted by circles are the mean blood flow values, at various, increasing doses of acetylcholine from the four patients before the first treatment. The curves denoted by triangles are mean values from one day after the conclusion of the course of treatments. The curves denoted by squares are mean values from twenty eight days after the conclusion of the course of treatments. The dosage response trend is clearly apparent from the curves presented as FIG. 3.

EXAMPLE 4

The iontophoresis data obtained from all four patients as described above, was subjected to statistical analysis, using the data of each of the four patients obtained before any treatment, and the data obtained from all four patients two to three to four weeks after completion of the course of 10 treatments (visit 12).

As noted above, in obtaining the curves shown on FIG. 2, the mean flow at each epoch is plotted against time, with the mean plotted at the mid time point of each epoch. Since the graphs indicate that the flow increased in a sigmoid fashion, the slope of the increase was calculated, in each case, using the mean flows from the epoch with a curve starting to rise, to the point where the curve started to become asymptotic. The regression analyses used to calculate these slopes all accounted for greater than 85% of the variation, and were therefore considered a very good fit. There was also calculated a total area under the curve (AUC) from the point where the curve started to rise, to epoch 10. The maximum recorded mean flow and the area under the curve during epoch 11 were also analyzed.

Table 1 summarizes these results. It indicates that the increase in flow in response to acetylcholine was higher post treatment, since the maximum flow, the AUC during the increase and the AUC in epoch 11 were higher post treatment, to a statistically significant extent, even on the basis of four patients (the P value being 0.012, 0.020 and 0.040 respectively). The slope was also greater, but not significantly so.

TABLE 1

SUMMARY OF ANALYSIS OF IONTOPHORESIS DATA

Drug	Variable	Baseline Before Treatment		Visit 12 After Course of Treatment		Visit 12 Minus Baseline	95% Confidence Interval	P Value from T-Test
		Mean	SD	Mean	SD			
Acetyl Choline	Slope of Increase	36.55	17.360	48.1	12.065	12.26	-1.56, 26.08	0.067
Acetyl Choline	Maximum Flow	211.4	40.67	272.3	22.68	60.93	25.96, 95.89	0.012
Acetyl Choline	AUC during increase	80695	24238.1	106708	15247.0	26013	7899, 44127	0.020
Acetyl Choline	AUC in epoch 11	64139	13167.0	83765	6622.3	19626	2106, 37145	0.040

EXAMPLE 5

Nineteen normal, healthy volunteers, 15 males, 4 females, aged between 20 and 30 years, were enrolled in the study. They were blindly assigned to two groups, 14 (10 males, 4 females) being given the treatment, the remaining 5 males constituting the control group. The volunteers were required to refrain from smoking during the study and to avoid taking drugs likely to affect platelet function, as recommended by the British Society of Haematology (1988). Individuals were bled by venepuncture, and re-injected with 10 mL of their own blood on five occasions over a period of two weeks. Thus the injections were administered at 2-3 day intervals according to the following protocol:

Day	Bleed vol (ml)	Re-inject vol (ml)
Mon	40	10
Wed	20	10
Fri	20	10
Mon	20	10
Wed	10	10
Wed(+2 h)	30	—
Fri	10	—

Individuals in the treatment group received five intramuscular (gluteal) injections of 10 mL autologous blood which had been treated as described in Example 1 above. Individuals assigned to the control group were re-injected with 10 mL of their own untreated blood and the study was performed blind, in that neither the subjects, the supervising clinician nor the laboratory staff performing the analyses were aware of the group to which an individual was assigned.

Prostacyclin levels in peripheral blood were estimated from the plasma concentration of its stable metabolite, 6-keto-prostaglandin-Fl $\alpha$  (Wu et al., "Journal of Clinical Investigation" 75; 168-174, 1985), using a commercially available radioimmunoassay from Amersham International, U.K. The leukocyte surface markers CD25 (the  $\alpha$ -subunit of the IL-2 receptor), the MHC Class 2 antigen HLA-DR and the monocyte-specific Ber-Mac 3 were assessed in mononuclear cells (monocytes, T-cells and B-cells), isolated by density gradient centrifugation, using immunocytochemical staining with commercially available monoclonal antibodies. Quantitation of CD25, HLA-DR and Ber-Mac 3 positive cells was performed microscopically, with manual counting, and numbers were expressed as a percentage of the leukocyte common antigen positive (CD45+) cells.

Statistical Analysis: Significance was determined using Student's t-test for paired data to compare the post-treatment times with pre-treatment values. Results from control and treated groups of individuals were also compared.

Prostacyclin—Measured as 6-keto-prostaglandin Fl $\alpha$

The results from the treated group and control groups are shown in Tables 2 and 3. Table 4 shows a summary of the statistical analysis of these data. One subject (number 3) was excluded from the data due to cigarette smoking.

Within the treated group, the post-treatment 6-keto-PGFl $\alpha$  concentrations were significantly ( $p < 0.05$ ) higher on two of the five post-treatment measurement occasions, post-1 and post-4, when compared with the pre-treatment baseline values. No such significant differences were observed in the placebo-treated control group.

TABLE 2

The concentrations of 6-keto-prostaglandin Fl $\alpha$  [pg/mL] in peripheral blood from treated volunteers before and after treatment.

Treated Subject No.	Pre-Treatment (Baseline)	Post-1	Post-2	Post-3	Post-4	Post-5
1	55.3	68.4	58.2	59.8	101.8	51.4
2	16.3	12.9	14.2	17.2	24.0	25.0
4	16.8	34.0	17.3	51.0	49.0	60.0
5	17.2	44.4	30.8	25.8	20.0	37.0
6	53.8	56.6	72.0	44.7	88.5	68.8
7	23.4	34.7	31.8	15.3	24.5	54.6
8	30.7	27.7	23.6	38.4	34.6	26.4
9	44.1	33.0	38.6	29.7	12.3	21.9
10	16.1	25.5	20.0	29.4	22.1	15.1
11	10.3	13.2	17.4	13.1	37.5	11.2
12	43.0	82.8	42.7	107.0	68.2	56.2
13	22.2	24.1	33.0	15.9	10.6	23.5
14	14.8	17.7	18.4	27.2	47.6	36.7
Mean	28.00	36.54	32.15	36.50	41.59	37.52

TABLE 3

The concentration of 6-keto-prostaglandin Fl $\alpha$  [pg/mL] in peripheral blood from placebo-treated (control) volunteers before and after a course of injections of untreated blood.

Control Subject No.	Pre-Treatment (Baseline)	Post-1	Post-2	Post-3	Post-4	Post-5
1	34.0	29.0	45.0	31.0	12.0	11.0
2	32.0	36.0	12.0	35.5	37.5	30.5
3	52.5	62.5	25.3	18.0	49.0	37.0
4	29.0	28.5	57.0	38.0	44.0	29.5
5	25.5	96.0	25.2	39.0	33.0	23.0
Mean	34.60	50.40	32.90	32.30	35.10	26.20

TABLE 4

Statistical analysis of the data of Tables 2 and 3.

Treatment Time	Base-line	1	2	3	4	5
Control Baseline vs Control	—	0.3191	0.8742	0.8003	0.941	0.1426
Significance	—	ns	ns	ns	ns	ns
Treated Baseline vs Treated	—	0.0434	0.0648	0.1672	0.0444	0.0687
Significance	—	<0.05	ns	ns	<0.05	NS
Treated vs Control	0.3253	0.3758	0.9385	0.6107	0.5359	0.1208
Significance	ns	ns	ns	ns	ns	ns

Expression of CD25 on Peripheral Blood Mononuclear Cells

The proportion of cells expressing CD25, measured as a percentage of all CD45+ mononuclear cells, is shown in Tables 5 and 6 below. Table 7 shows the statistical analysis of these data. The results show that, on each of the five occasions investigated during and after a course of treatment, a significantly higher proportion of peripheral blood mononuclear cells expressed CD25 compared to the pre-treatment values. There was no such increased level of expression of this marker in the placebo treated control group. In addition, at post-treatment times 2 and 3 the treated

13

group showed a significantly higher expression of this marker than the control group.

TABLE 5

The proportion of cells expressing CD25, as a percentage of CD45+ cells, in peripheral blood from treated volunteers before and after a course of treatment.

Treated Subject No.	Pre-Treatment (Baseline)	Post-1	Post-2	Post-3	Post-4	Post-5
1	31	43	51	45	45	55
2	12	75	39	21	57	74
3	29	69	72	27	100	45
4	12	22	32	99	12	10
5	50	96	89	87	85	71
6	40	42	46	58	43	45
7	53	50	50	64	47	58
8	47	51	41	46	36	38
9	48	45	46	76	45	52
10	50	53	77	63	56	82
11	17	26	34	55	58	30
12	34	32	58	40	31	40
13	40	42	60	72	56	88
14	47	48	48	53	57	71
Mean =	36.29	49.57	53.07	57.57	52.00	54.21

TABLE 6

The proportion of cells expression CD25 (as a percentage of CD45+ cells) in peripheral blood from placebo-treated (control) volunteers before and after a course of injections of untreated blood.

Control Subject No.	Pre-Treatment (Baseline)	Post-1	Post-2	Post-3	Post-4	Post-5
1	47	42	25	32	46	35
2	48	32	52	28	18	32
3	25	39	35	30	21	34
4	22	73	31	17	45	57
5	60	49	46	44	40	34
Mean =	40.40	47.00	37.80	30.20	34.00	38.40

TABLE 7

Statistical analysis of the data in Tables 5 & 6.

Treatment Time	Base-line	1	2	3	4	5
Control Baseline vs Control Significance	—	0.6175	0.7093	0.088	0.5189	0.8629
Treated Baseline vs Treated Significance	—	ns	ns	ns	ns	ns
Treated vs Control Significance	0.6343	<0.05	<0.002	<0.005	<0.05	<0.005
Control vs Treated Significance	ns	ns	<0.05	<0.002	ns	ns

Expression of HLA-DR on Peripheral Blood Mononuclear Cells

The proportion of cells expressing HMA-DR, measured as a percentage of all CD45+ mononuclear cells, is shown in Tables 8 & 9 and Table 10 shows a summary of the statistical analysis of these data. As observed with CD25, the expression of HLA-DR was significantly enhanced on each of the five occasions investigated during and after a course of VasoCare™ therapy. Within the treated group, all post-

14

treatment values were significantly higher than the pre-treatment baseline. As for CD25, no significant changes were observed in the control group. Comparison of the treated with the placebo group showed that, at post-treatment times 2, 3, 4, and 5, the treated group showed significantly greater i-DR expression than the control group.

TABLE 8

The proportion of cells expressing HLA-DR (as a percentage of CD45+ cells) in peripheral blood from treated volunteers before and after a course of treatment.

Treated Subject No.	Pre-Treatment (Baseline)	Post-1	Post-2	Post-3	Post-4	Post-5
1	39	37	48	36	40	47
2	15	37	33	35	54	82
3	49	61	52	52	96	49
4	8	32	31	39	14	17
5	26	57	76	92	30	62
6	41	50	63	61	54	54
7	46	53	73	56	54	62
8	39	37	48	36	40	47
9	41	44	45	70	55	65
10	28	21	52	37	28	60
11	34	34	45	54	50	49
12	48	44	71	35	53	75
13	25	42	35	75	54	91
14	45	48	52	59	61	60
Mean =	34.57	42.64	51.71	52.64	48.79	58.57

TABLE 9

The proportion of cells expressing HLA-DR (as a percentage of CD45+ cells) in peripheral blood from placebo-treated (control) volunteers before and after a course of injections of untreated blood.

Control Subject No.	Pre-Treatment (Baseline)	Post-1	Post-2	Post-3	Post-4	Post-5
1	20	15	19	17	14	24
2	39	44	42	32	31	41
3	28	36	30	33	33	47
4	33	30	37	39	47	56
5	55	33	43	51	28	40
Mean =	35.00	31.60	34.20	34.40	32.00	41.60

TABLE 10

Statistical analysis of the data in Tables 8 & 9.

Treatment Time	Base-line	1	2	3	4	5
Control Baseline vs Control Significance	—	0.5518	0.7978	0.8276	0.6331	0.3849
Treated Baseline vs Treated Significance	—	NS	NS	NS	NS	NS
Treated vs Control Significance	0.9516	<0.05	<0.0005	<0.01	<0.005	<0.001
Control vs Treated Significance	ns	ns	<0.02	<0.05	<0.05	<0.05

Expression of Ber-Mac 3 Peripheral Blood Mononuclear Cells

The proportion of cells expressing Ber-Mac 3, a monocyte-specific surface marker, measured as a percentage of all CD45 positive mononuclear cells is shown in Tables

13 & 14 and Table 15 shows a summary of the statistical analysis of these data. As observed with the other leucocyte surface markers, the expression of Ber-Mac 3 was significantly enhanced during the course of therapy. Within the treated group, post-therapy values were significantly higher than the pre-treatment baseline at times 1 & 2. As in the case of the other two markers investigated, no significant changes were observed in the control group. Comparisons of the treated with the placebo group showed only a single significant difference of Ber-Mac 3 expression, at time 2.

TABLE 11

The proportion of cells expressing Ber-Mac 3 (as a percentage of CD45+ cells) in peripheral blood from treated volunteers before and after a course of therapy.

Treated Subject No.	Pre-Treatment (Baseline)	Post-1	Post-2	Post-3	Post-4	Post-5
1	41	37	52	25	34	47
2	19	31	37	32	34	18
3	39	39	44	46	61	47
4	39	42	55	60	33	65
5	19	40	47	34	37	16
6	46	49	52	35	38	25
7	30	30	35	34	37	46
8	38	36	45	34	45	44
9	38	42	37	40	32	40
10	30	28	47	38	27	34
11	34	58	35	44	44	40
12	37	48	47	32	56	70
13	29	38	58	69	32	47
14	33	29	28	35	35	26
Mean $\pm$	33.71	39.07	44.21	39.86	38.93	40.36

TABLE 12

The proportion of cells expressing Ber-Mac 3 (as a percentage of CD45+ cells) in peripheral blood from placebo-treated (control) volunteers before and after a course of injections of untreated blood.

Control Subject No.	Pre-Treatment (Baseline)	Post-1	Post-2	Post-3	Post-4	Post-5
1	29	21	25	27	26	31
2	30	27	36	41	49	43
3	35	76	38	33	54	68
4	19	21	36	29	39	64
5	38	20	38	36	23	22
Mean $\pm$	30.20	33.00	34.60	33.20	38.20	45.60

TABLE 13

Statistical analysis of the data in Tables 11 and 12.

Treatment Time	Baseline	1	2	3	4	5
Control Baseline vs Control Significance	—	ns	ns	ns	ns	ns
Treatment Baseline vs Treated	—	0.0427	0.0019	0.1255	0.0845	0.0915

TABLE 13-continued

Statistical analysis of the data in Tables 11 and 12.

Treatment Time	Baseline	1	2	3	4	5
Significance Treated vs Control Significance	—	p < 0.05	p < 0.002	ns	ns	ns
Control Significance	—	ns	p < 0.02	ns	ns	ns

What is claimed is:

1. A process for stimulating leukocytes in a mammalian patient comprising:

(a) extracting an aliquot of blood from the patient;

(b) subjecting the extracted aliquot of blood simultaneously to an elevated temperature stressor from 37° C. to 55° C., ultraviolet radiation stressor at a C-band wavelength, and an oxidative environment stressor comprising ozone thereby stimulating leukocytes in the aliquot of blood; and

(c) reinjecting the blood aliquot into the patient.

2. The process according to claim 1, wherein the oxidative environment stressor is a gaseous oxidizing agent comprising a mixture of medical grade oxygen and ozone.

3. The process according to claim 2, wherein the gaseous oxidizing mixture comprises medical grade oxygen and 1.0–100 µg ozone per mL of the gaseous oxidizing mixture, applied to the aliquot at a rate of from 0.01–2.0 liters/minute.

4. The process according to claim 2, wherein the gaseous oxidizing mixture comprises medical grade oxygen and from 5–50 µg ozone per mL of the gaseous oxidizing mixture, applied to the aliquot at a rate of from 0.05–5.0 liters/minute.

5. The process according to claim 2, wherein the gaseous oxidizing mixture comprises medical grade oxygen and 12.5 µg ozone per mL of the gaseous oxidizing mixture, applied to the aliquot at a rate of 0.06 liters/minute.

6. The process according to claim 1 wherein the ultraviolet radiation stressor comprises output from a UV lamp emitting at a C-band wavelength.

7. The process according to claim 1 wherein the aliquot is human blood, and has a volume of from 0.1–100 mLs.

8. The process according to claim 1, wherein the aliquot has been subjected to said stressors for a period of time of from 0.5–60 minutes.

9. The process according to claim 1, wherein the ultraviolet radiation stressor comprises output from a UV lamp emitting at a wavelength of 253.7 nm.

10. The process according to claim 1, wherein the aliquot is human blood, and has a volume of 5–15 mLs.

11. The process according to claim 1, wherein the aliquot is human blood, and has a volume of 10 mLs.

12. The process according to claim 1, wherein the aliquot has been subjected to said stressors for a period of time of from 2–5 minutes.

13. The process according to claim 1, wherein the aliquot has been subjected to said stressors for a period of time of 3 minutes.



US 20040253213A1

(19) **United States**

(12) **Patent Application Publication**

**Bolton et al.**

(10) **Pub. No.: US 2004/0253213 A1**

(43) **Pub. Date: Dec. 16, 2004**

(54) **TREATMENT OF ENDOTHELIN-RELATED DISORDERS**

(76) Inventors: **Anthony E. Bolton**, Bakewell (GB);  
**Arkady Mandel**, North York (CA);  
**Duncan J. Stewart**, Toronto (CA)

Correspondence Address:  
**FOLEY & LARDNER LLP**  
**THREE PALO ALTO SQUARE**  
**3000 EL CAMINO REAL**  
**SUITE 100**  
**PALO ALTO, CA 94306 (US)**

(21) Appl. No.: **10/815,509**

(22) Filed: **Mar. 31, 2004**

**Related U.S. Application Data**

(60) Provisional application No. 60/460,456, filed on Apr. 3, 2003.

**Publication Classification**

(51) Int. Cl.<sup>7</sup> ..... **A61K 45/00; A61K 33/00**

(52) U.S. Cl. .... **424/93.7; 424/600**

(57) **ABSTRACT**

Endothelin-related disorders in mammals can be alleviated by administration to such patients of one or more aliquots of mammalian blood subjected to two or more stressors selected from temperature stressors, electromagnetic emissions and oxidative environments.

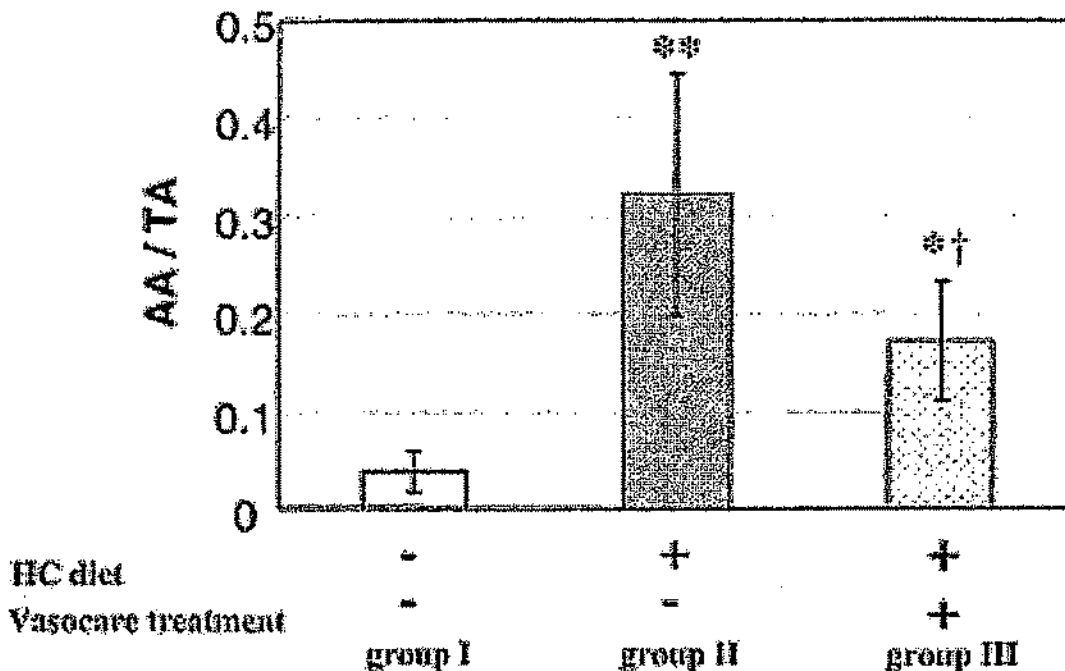
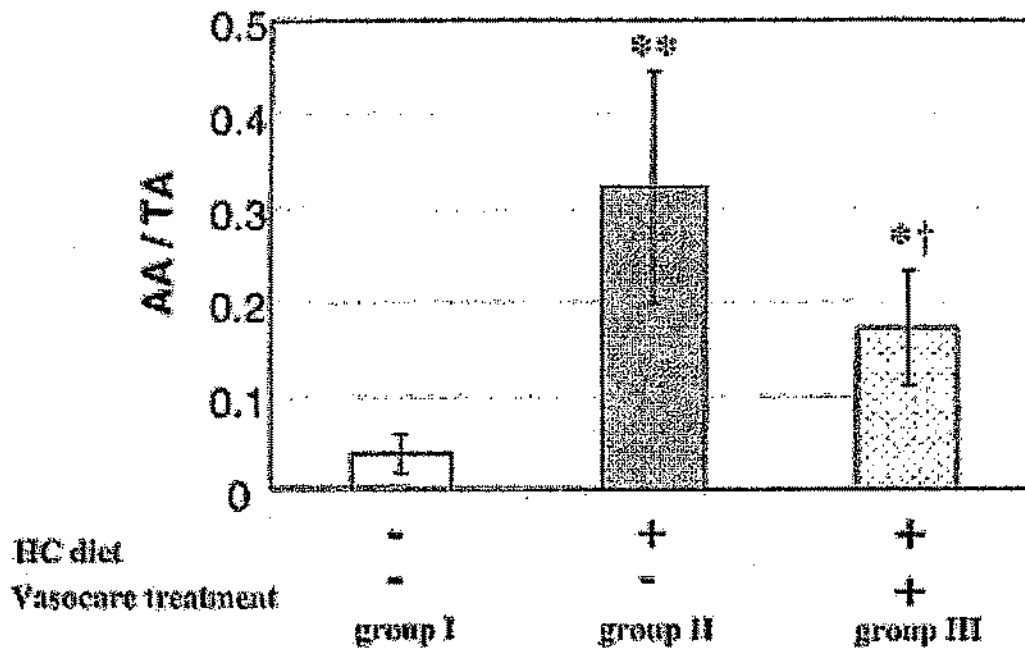




FIG. 1



## TREATMENT OF ENDOTHELIN-RELATED DISORDERS

### CROSS-REFERENCE TO RELATED CASES

[0001] This application claims the benefit of U.S. Patent Application No. 60/460,456 filed Apr. 3, 2002, the disclosure of which is incorporated herein by reference.

### FIELD OF THE INVENTION

[0002] This invention relates to endothelin, and methods for the treatment or prophylaxis of mammalian disorders associated with excessive levels of endothelin.

### REFERENCES

[0003] 1. Babaei, Saicid, et al. "Effects of VasoCare therapy on the initiation and progression of atherosclerosis." *Atherosclerosis*. 162 (2002) 45-53.

[0004] The publication is hereby incorporated by reference in its entirety.

### BACKGROUND OF THE INVENTION

[0005] Endothelins are a family of 21 amino acid peptides produced by endothelial cells. There are three known isoforms of endothelin, namely endothelin-1 (ET-1), endothelin-2 (ET-2) and endothelin-3 (ET-3). Of the three known isoforms, ET-1 is the major isoform produced by the vascular endothelium and is an extremely potent vasoconstrictor, with veins being 3 to 10 times more sensitive to the effects of ET-1 than arteries.

[0006] The vasoconstricting effect of endothelin is caused by the binding of endothelin to its receptor on the vascular smooth muscle cells. Thus far, two endothelin receptors have been characterized in mammalian species, known as the ETA and ETB receptors. The ETA receptor, restricted to vascular smooth muscle, is relatively selective for ET-1 and mediates vasoconstriction. The ETB receptor, primarily located in the endothelium, mediates vasodilatation through the production of endothelium-dependent vasodilators, such as nitric oxide and prostacyclin.

[0007] A pathophysiological role for the endothelins has been postulated in a large number of human disease states.

[0008] One example of such a disease state is primary pulmonary hypertension (PPH), a rare condition of unknown etiology which affects mainly young people. PPH causes progressive shortening of breath and most of those affected are dead within 4 years of diagnosis. Patients with PPH have increased circulating endothelin levels which may be caused by increased pulmonary endothelin synthesis, and there is evidence to suggest that increased endothelin production may be directly involved in the pathogenesis of PPH (Ferro and Webb, "The Clinical Potential of Endothelin Receptor Antagonists in Cardiovascular Medicine", *Drugs* 1996 January; 51(1): 12-27).

[0009] Another example of such a disease state is glaucoma, which is a group of vascular disorders characterized by degeneration of the optic nerve which carries images from the retina to the brain. The disease is associated with high intraocular pressure and impaired ocular blood flow. There are reports in the literature that ET-1 plasma levels are elevated in some forms of glaucoma (Cellini et al., "Color

Doppler imaging and plasma levels of endothelin-1 in low-tension glaucoma": *Acta Ophthalmol Scand Suppl* 1997; (224): 11-3). Furthermore, endothelin appears to be involved in the regulation of intraocular pressure and the modulation of ocular blood flow (Haelliger et al., "Potential role of nitric oxide and endothelin in the pathogenesis of glaucoma", 1: *Surv Ophthalmol* 1999 June; 43 Suppl 1: S51-8; and Sugiyama et al., "Association of endothelin-1 with normal tension glaucoma: clinical and fundamental studies" 6: *Surv Ophthalmol* 1995 May; 39 Suppl 1: S49-56), suggesting that endothelin may be involved in the pathogenesis of at least some forms of the disease.

[0010] Endothelin also plays a potential role in the progression of atherosclerosis (Rubanyi and Polokoff, "Endothelins: Molecular Biology, Biochemistry, Pharmacology, Physiology and Pathophysiology", *Pharmacological Reviews* Vol. 46, No. 3, 1994, pp. 325-415) incorporated herein by reference. This is supported by a number of factors, including the following: plasma ET-1 levels are elevated in patients with atherosclerosis and in animal models of hypercholesterolemia; expression of the ET-1 gene is induced, synthesis and release of ET-1 peptide is increased, and binding of exogenous ET-1 is enhanced in the atheromatous vascular lesion; ET-1 production by the endothelium and macrophages is stimulated by oxidized LDL and several cytokines involved in the vascular injury process; and ET-1-induced vasoconstriction is potentiated in atherosclerosis.

[0011] Endothelin 1 (ET-1) is also a factor in promotion of angiogenesis, the development of blood vessels, a process which, properly balanced, is important in the restoration and maintenance of good health in mammals. Excess angiogenesis, however, can cause serious health problems, e.g. in recovery from cardiac incidents and in restenosis. ET-1 is known to stimulate the secretion of vascular endothelial growth factor VEGF (see for example Spinella, F. et. al., *J. Biol. Chem.* 2002 Aug. 2; 277 (31): 27850-5), which promotes angiogenesis. Down-regulation of ET-1 is therefore the basis of potential treatments of conditions involving excess angiogenesis.

[0012] Although the symptoms of many endothelin-related disorders can be treated, there is a lack of available treatments which address the underlying role of endothelin in these disorders. Accordingly, the need exists for an effective treatment of endothelin-related disorders.

### SUMMARY OF THE INVENTION

[0013] It has now been found that levels of endothelin can be reduced in mammalian patients by administration to such patients of one or more aliquots of stressed mammalian blood.

[0014] The aliquot of blood is stressed by being subjected to two or more stressors which have been found to modify the blood. According to the invention, the blood aliquot can be modified by subjecting the blood, or separated cellular or non-cellular fractions of the blood, or mixtures of the separated cells and/or non-cellular fractions of the blood, to stressors selected from temperature stressors, electromagnetic emissions and oxidative environments, or any combination of such stressors, simultaneously or sequentially.

[0015] Accordingly, in one aspect the present invention provides a method of alleviating the symptoms of an endot-

helin-related disorder in a mammalian patient suffering therefrom, comprising: (a) treating an aliquot of the patient's blood ex vivo with at least two stressors selected from the group consisting of a temperature above or below body temperature, an electromagnetic emission and an oxidative environment; and (b) administering the aliquot of blood treated in step (a) to the patient.

#### BRIEF DESCRIPTION OF THE DRAWINGS

[0016] The FIGURE of accompanying drawings comprise the following:

[0017] FIG. 1 is a graphical presentation of atherosclerotic area relative to total aortic luminal surface for LDL-R deficient mice treated according to Example 1.

#### DETAILED DESCRIPTION OF PREFERRED EMBODIMENTS

[0018] According to a preferred process of the present invention, an aliquot of blood is extracted from a mammalian subject, preferably a human, and the aliquot of blood is treated ex vivo with certain stressors, described in more detail below. The terms "aliquot", "aliquot of blood" or similar terms used herein include whole blood, separated cellular fractions of the blood including platelets, separated non-cellular fractions of the blood including plasma, and combinations thereof. The effect of the stressors is to modify the blood, and/or the cellular or non-cellular fractions thereof, contained in the aliquot. The modified aliquot is then re-introduced into the subject's body by any method suitable for delivery, e.g., preferably selected from intra-arterial injection, intramuscular injection, intravenous injection, subcutaneous injection, intraperitoneal injection, and oral, nasal or rectal administration.

[0019] The stressors to which the aliquot of blood is subjected ex vivo according to the method of the present invention are selected from temperature stress (blood temperature above or below body temperature), an oxidative environment and an electromagnetic emission, in any combination, simultaneously or sequentially.

[0020] Preferably also, the aliquot of blood is in addition subjected to mechanical stress. Such mechanical stress is suitably that applied to the aliquot of blood by extraction of the blood aliquot through a conventional blood extraction needle, or a substantially equivalent mechanical stress, applied shortly before the other chosen stressors are applied to the blood aliquot. This mechanical stress may be supplemented by the mechanical stress exerted on the blood aliquot by bubbling gases through it, such as ozone/oxygen mixtures, as described below.

[0021] Suitably, in human subjects, the aliquot has a volume sufficient that, when re-introduced into the subject's body, at least partial alleviation of an endothelin-related disorder is achieved in the subject. Preferably, the volume of the aliquot is up to about 400 ml, preferably from about 0.1 to about 100 ml, more preferably from about 5 to about 15 ml, even more preferably from about 8 to about 12 ml, and most preferably about 10 ml. When a cellular fraction is used instead of whole blood, the aliquot should contain the number of blood cells which would ordinarily be contained in whole blood of the aforementioned volumes, e.g.  $10^5$  to  $10^{12}$ .

[0022] It is preferred, according to the invention, to apply all three of the aforementioned stressors simultaneously to the aliquot under treatment, in order to ensure the appropriate modification to the blood. It may also be preferred in some embodiments of the invention to apply any two of the above stressors, for example to apply temperature stress and oxidative stress, temperature stress and an electromagnetic emission, or an electromagnetic emission and oxidative stress. Care must be taken to utilize an appropriate level of the stressors to thereby effectively modify the blood to alleviate the endothelin-related disorder in the subject.

[0023] The temperature stressor warms the aliquot being treated to a temperature above normal body temperature or cools the aliquot below normal body temperature. The temperature is selected so that the temperature stressor does not cause excessive hemolysis in the blood contained in the aliquot and so that, when the treated aliquot is injected into a subject, alleviation of the disorder will be achieved. Preferably, the temperature stressor is applied so that the temperature of all or a part of the aliquot is up to about  $55^\circ\text{C}$ ., and more preferably in the range of from about  $-5^\circ\text{C}$ . to about  $55^\circ\text{C}$ .

[0024] In some preferred embodiments of the invention, the temperature of the aliquot is raised above normal body temperature, such that the mean temperature of the aliquot does not exceed a temperature of about  $55^\circ\text{C}$ ., more preferably from about  $40^\circ\text{C}$ . to about  $50^\circ\text{C}$ ., even more preferably from about  $40^\circ\text{C}$ . to about  $44^\circ\text{C}$ ., and most preferably about  $42.5\pm 1^\circ\text{C}$ .

[0025] In other preferred embodiments, the aliquot is cooled below normal body temperature such that the mean temperature of the aliquot is within the range of from about  $-5^\circ\text{C}$ . to about  $36.5^\circ\text{C}$ ., even more preferably from about  $10^\circ\text{C}$ . to about  $30^\circ\text{C}$ ., and even more preferably from about  $15^\circ\text{C}$ . to about  $25^\circ\text{C}$ .

[0026] The oxidative environment stressor can be the application to the aliquot of solid, liquid or gaseous oxidizing agents. Chemical oxidants such as hydrogen peroxide can be used. Preferably, it involves exposing the aliquot to a mixture of medical grade oxygen and ozone gas, most preferably by bubbling through the aliquot, at the aforementioned temperature range, a stream of medical grade oxygen gas having ozone as a minor component therein. The ozone content of the gas stream and the flow rate of the gas stream are preferably selected such that the amount of ozone introduced to the blood aliquot, either on its own or in combination with other stressors, does not give rise to excessive levels of cell damage such that the therapy is rendered ineffective. Suitably, the gas stream has an ozone content of up to about  $300\ \mu\text{g/ml}$ , preferably up to about  $100\ \mu\text{g/ml}$ , more preferably about  $30\ \mu\text{g/ml}$ , even more preferably up to about  $20\ \mu\text{g/ml}$ , particularly preferably from about  $10\ \mu\text{g/ml}$  to about  $20\ \mu\text{g/ml}$ , and most preferably about  $14.5\pm 1.0\ \mu\text{g/ml}$ . The gas stream is suitably supplied to the aliquot at a rate of up to about 2.0 litres/min, preferably up to about 0.5 litres/min, more preferably up to about 0.4 litres/min, even more preferably up to about 0.33 litres/min, and most preferably about  $0.24\pm 0.024$  litres/min. The lower limit of the flow rate of the gas stream is preferably not lower than 0.01 litres/min, more preferably not lower than 0.1 litres/min, and even more preferably not lower than 0.2 litres/min.

[0027] The electromagnetic emission stressor is suitably applied by irradiating the aliquot under treatment from a source of an electromagnetic emission while the aliquot is maintained at the aforementioned temperature and while the oxygen/ozone gaseous mixture is being bubbled through the aliquot. Preferred electromagnetic emissions are selected from photonic radiation, more preferably UV, visible and infrared light, and even more preferably UV light. The most preferred UV sources are UV lamps emitting primarily UV-C band wavelengths, i.e. at wavelengths shorter than about 280 nm. Such lamps may also emit amounts of visible and infrared light. Ultraviolet light corresponding to standard UV-A (wavelengths from about 315 to about 400 nm) and UV-B (wavelengths from about 280 to about 315) sources can also be used. For example, an appropriate dosage of such UV light, applied simultaneously with the aforementioned temperature and oxidative environment stressors, can be obtained from lamps with a combined power output of from about 45-65 mW/cm<sup>2</sup>. Up to eight such lamps surrounding the sample bottle, with a combined output at 253.7 nm of 15-25 watts, operated at an intensity to deliver a total UV light energy at the surface of the blood of from about 0.025 to about 10 joules/cm<sup>2</sup>, preferably from about 0.1 to about 3.0 joules/cm<sup>2</sup>. Preferably, four such lamps are used.

[0028] The time for which the aliquot is subjected to the stressors is normally within the time range of up to about 60 minutes. The time depends to some extent upon the chosen intensity of the electromagnetic emission, the temperature, the concentration of the oxidizing agent and the rate at which it is supplied to the aliquot. Some experimentation to establish optimum times may be necessary on the part of the operator, once the other stressor levels have been set. Under most stressor conditions, preferred times will be in the approximate range of from about 2 to about 5 minutes, more preferably about 3 minutes. The starting blood temperature, and the rate at which it can be warmed or cooled to a predetermined temperature, tends to vary from subject to subject. Warming is suitably by use of one or more infrared lamps placed adjacent to the aliquot container. Other methods of warming can also be adopted.

[0029] As noted above, it is preferred to subject the aliquot of blood to a mechanical stressor, as well as the chosen stressor(s) discussed above. Extraction of the blood aliquot from the patient through an injection needle constitutes the most convenient way of obtaining the aliquot for further extracorporeal treatment, and this extraction procedure imparts a suitable mechanical stress to the blood aliquot. The mechanical stressor may be supplemented by subsequent processing, for example the additional mechanical shear stress caused by bubbling as the oxidative stressor is applied.

[0030] In the practice of the preferred process of the present invention, the blood aliquot may be treated with the stressors using an apparatus of the type described in U.S. Pat. No. 4,968,483 to Mueller, incorporated herein by reference. The aliquot is placed in a suitable, sterile, UV light-transmissive container, which is fitted into the machine. The UV lamps are switched on for a fixed period before the gas flow is applied to the aliquot providing the oxidative stress, to allow the output of the UV lamps to stabilize. The UV lamps are typically on while the temperature of the aliquot is adjusted to the predetermined value, e.g. 42.5±1° C. Then the oxygen/ozone gas mixture, of

known composition and controlled flow rate, is applied to the aliquot, for the predetermined duration of up to about 60 minutes, preferably 2 to 5 minutes and most preferably about 3 minutes as discussed above, so that the aliquot experiences all three stressors simultaneously. In this way, blood is appropriately modified according to the present invention to achieve the desired effects.

[0031] A subject preferably undergoes a course of treatments, each individual treatment comprising removal of a blood aliquot, treatment thereof as described above and re-administration of the treated aliquot to the subject. A course of such treatments may comprise daily administration of treated blood aliquots for a number of consecutive days, or may comprise a first course of daily treatments for a designated period of time, followed by an interval and then one or more additional courses of daily treatments.

[0032] In one preferred embodiment, the subject is given an initial course of treatments comprising the administration of 1 to 6, more preferably 4 to 6 aliquots of treated blood. In another preferred embodiment, the subject is given an initial course of therapy comprising administration of from 2 to 4 aliquots of treated blood, with the administration of any pair of consecutive aliquots being either on consecutive days, or being separated by a rest period of from 1 to 21 days on which no aliquots are administered to the patient, the rest period separating one selected pair of consecutive aliquots being from about 3 to 15 days. In a more specific, preferred embodiment, the dosage regimen of the initial course of treatments comprises a total of three aliquots, with the first and second aliquots being administered on consecutive days and a rest period of 11 days being provided between the administration of the second and third aliquots. For optimum effectiveness of the treatment, it is preferred that no more than one aliquot of modified blood be administered to the subject per day, in one or more injection sites, and that the maximum rest period between any two consecutive aliquots during the course of treatment be no greater than about 21 days.

[0033] It may be preferred to subsequently administer additional courses of treatments following the initial course of treatments. Preferably, subsequent courses of treatments are administered following a rest period of several weeks or months, preferably at least about three weeks, after the end of the initial course of treatments. In one particularly preferred embodiment, the subject receives a second course of treatments comprising the administration of one aliquot of treated blood every 30 days following the end of the initial course of treatments, for a period of 6 months. It may also be preferred in some circumstances to follow one or more of the above-described courses of treatment by periodic "booster" treatments, if necessary, to maintain the desired effects of the present invention. For example, it may be preferred to administer booster treatments at intervals of 3 to 4 months following the initial course of treatment.

[0034] It will be appreciated that the spacing between successive courses of treatments should be such that the positive effects of the treatment of the invention are maintained, and may be determined on the basis of the observed response of individual subjects.

[0035] The invention is further illustrated and described with reference to the following specific examples.

## EXAMPLE 1

**[0036]** Model:

**[0037]** The purpose of the experiment is to determine the effects of treatment according to the present invention on endothelin levels in the LDL receptor (LDL-R) deficient mouse model, a widely used transgenic atherosclerosis model created by targeted disruption of the LDL receptor.

**[0038]** The LDL-R deficient mouse model shows intolerance to cholesterol feeding and develops widespread atherosclerotic changes which progress to mature fibrous lesions morphologically indistinguishable from established human atherosclerosis. Apart from the defined genetic abnormality causing predisposition to atherosclerosis, this model has the advantage of rapid development of widespread atherosclerosis within 6 to 8 weeks following institution of cholesterol feeding.

**[0039]** Protocol:

**[0040]** LDL-R deficient mice in the C57BL/6J background were purchased from Jackson Laboratories. A total of 42 mice were entered into the study at 22 weeks of age. The length of the study was 8 weeks. The mice were maintained on a 12 hour dark/12 hour light cycle with unrestricted access to food and water.

**[0041]** The animals were randomly assigned to three experimental groups as follows: (I) control (12 animals, normal diet); (II) high cholesterol diet with injections of saline (15 animals); and (III) high cholesterol diet with administration of stressed blood according to the invention (15 animals).

**[0042]** No differences in food intake, drinking patterns, or body weight were noted between animals from each group. The high cholesterol diet contained 1.25% cholesterol, 7.5% (wt/wt) cocoa butter, 7.5% casein, and 0.5% (wt/wt) sodium cholate.

**[0043]** To ensure proper food intake, food consumption and animal weight were monitored on a weekly basis. In previous experiments, it was demonstrated that 8 weeks of feeding with the high cholesterol diet results in substantial atherosclerosis development, particularly in the aortic arch and the descending thoracic aorta.

**[0044]** Treatment:

**[0045]** The 15 animals of Group III underwent a course of treatment by a preferred method of the invention. The treatments began four weeks after initiation of the study, with each of the animals of Group III receiving a total of three treatments on days 29, 30 and 42 of the high cholesterol feeding.

**[0046]** The blood to be stressed was taken from syngeneic animals by cardiac puncture, pooled and anti-coagulated with sodium citrate (10 ml of blood and 2 ml of 3.13% sodium citrate solution). The blood aliquot (12 ml) was transferred to a sterile, disposable, low-density polyethylene vessel for *ex vivo* treatment, and was then treated simultaneously with a gaseous oxygen/ozone mixture and ultraviolet light at elevated temperature using an apparatus as generally described in aforementioned U.S. Pat. No. 4,968,483 to Mueller et al.

**[0047]** The constitution of the gas mixture was  $14.5 \pm 1.0$   $\mu$ g ozone/ml, with the remainder of the mixture comprising medical grade oxygen. The gas mixture was bubbled through the aliquot at a rate of  $240 \pm 24$  ml/min for a period of 3 minutes. The temperature of the aliquot was held steady at  $42.5 \pm 1.0^\circ$  C. The UV light was within the UV-C band, and included a wavelength of 253.7 nm.

**[0048]** The treatment protocol consisted of administration, by intramuscular injection, of 30  $\mu$ l of the treated syngeneic blood into each animal of Group III.

**[0049]** In the animals of Group II, 30  $\mu$ l of saline blood was injected intramuscularly on days 29, 30 and 42 of high cholesterol feeding.

**[0050]** Assessment of Atherosclerosis:

**[0051]** After 8 weeks, the animals were anesthetized with zylaxine/ketamine and the heart was exposed. After nicking the vena cava to obtain blood samples, the animals were perfused via ventricular puncture, first with PBS to flush out the blood and then with 10% neutral buffered formalin for 3 minutes to fix the aorta. The thoracic aorta was dissected away from the thorax en bloc and stored in 10% formalin at 4EC. Pressure-fixed (10% formalin) aortae were removed en bloc and opened to allow a longitudinal full length inversion. The aortae were then mounted internally exposed on glass slides and stained with oil red O. The bright red staining (indicating lipid deposition) was then quantified using a computer assisted morphometric system, and expressed as a percentage of total aortic intimal surface.

**[0052]** Immunohistochemistry Studies

**[0053]** The aortae of 4 animals from each experimental group were divided into three regions: aortic arch, thoracic aorta and abdominal aorta. Paraffin sections (5  $\mu$ m thickness) were cut from each region and endogenous peroxidase activity was quenched by 3%  $H_2O_2$  in methanol for 20 minutes; nonspecific antibody binding was blocked with 10% goat serum in PBS for 30 minutes. Adjacent sections from each group of animals were immunostained using the following antibodies: (a) polyclonal rabbit ET-1 antibody (Peninsula Lab, Belmont, Calif.) at 1:200 dilution overnight at  $4^\circ$  C., and secondary reaction with goat anti-rabbit biotinylated antibody (1:250 dilution, Vector Laboratories, Burlingame, Calif.) for 45 min at room temperature; (b) polyclonal rat antibody to the mouse monocyte/macrophage marker MOMA-2 (Serotec Ltd., Oxford, United Kingdom) at 1:100 dilution overnight at  $4^\circ$  C., and secondary reaction with biotinylated rabbit anti-rat IgG (1:250 dilution, Vector Laboratories) for 45 minutes at room temperature; (c) monoclonal antibody to smooth muscle  $\alpha$ -actin (Boehringer Mannheim, Laval, Quebec) at 1:100 dilution for 60 minutes at room temperature and secondary reaction with biotinylated anti-mouse IgG (1:150 dilution, Vector Laboratories) for 30 minutes at room temperature. Following incubation with the secondary antibodies, the sections were treated with streptavidin-biotin-peroxidase complexes (Vectastain ABC kit, Vector Laboratories) for 30 minutes at room temperature. Diaminobenzadine was used as the peroxidase substrate and hematoxylin as the nuclear counterstain. Negative control slides were prepared by substituting preimmune rabbit serum for the primary antibody.

[0054] Statistical Analysis:

[0055] Statistical differences between groups were evaluated using the one-way ANOVA with post hoc student t-test where appropriate. Data are presented as mean  $\pm$ SD.

[0056] Results:

[0057] Only minimal lipid deposition was found in the animals of Group I receiving normal mouse chow, while the animals of Group II which received the high cholesterol diet and the sham treatments exhibited substantial aortic lipid deposition, with involvement of more than 30% of the aorta. In contrast, the aortic lesions were significantly less in the treated animals of Group III ( $p < 0.05$ ), demonstrating that the treatment of the invention significantly reduced the extent of aortic atherosclerosis. FIG. 1 shows mean values for atherosclerotic area (n=8, group I; n=12, group II and n=11, group III). Asterisks indicate statistical difference versus group I using the one-way ANOVA test in conjunction with the Bonferroni correction ( $*p < 0.05$ ;  $**p < 0.001$ ). The cross sign indicated a statistical difference versus group II using the one-way ANOVA test ( $p < 0.01$ ).

[0058] In addition, the animals which were treated according to the preferred method of the present invention were observed to have better general appearance, reduced skin xanthomatosis (eyelids, nose and paws), reduced limb swelling, and better appetite than the untreated animals which received the high cholesterol diet.

[0059] Immunostaining with monoclonal antibody to smooth muscle  $\alpha$ -actin revealed a similar pattern staining in both normal chow and high cholesterol fed animals, largely restricted to the medial layer of the vessels with only partial staining in the atherosclerotic lesion. In contrast, immunostaining with MOMA-2 showed a very dense accumulation of macrophages in the lesions of Group II animals, which was reduced with the treatment of the invention. Immunostaining for ET-1 on sequential sections revealed that expression of ET-1 was limited to endothelial cells and predominantly in the neointimal macrophage rich lesion of the atherosclerotic plaque of the high cholesterol fed animals. A negative control slide was prepared by substituting preimmune rabbit serum for the primary antibody. However, ET-1 staining was markedly reduced in the animals treated according to the invention.

[0060] The animals treated according to the method of the invention showed reduced atherosclerotic plaque formation, as well as reductions in area of macrophage and ET-1 staining. These results are consistent with a reduction in ET-1 production by the macrophages in the atherosclerotic plaque brought about by the method of the invention, which may be consistent with a decrease in chronic inflammation contributing to a reduction in progression of atherosclerosis in treated mice. Based on these results, it is expected that the method of the invention would be effective in the treatment of endothelin-related diseases, including those specifically mentioned above. Administration to patients susceptible to complication resulting from excess angiogenesis, e.g. patients recovering from cardiac events and liable to restenosis, is particularly indicated.

What is claimed is:

1. A method of alleviating the symptoms of, or prophylaxis of, an endothelin-related disease, which comprises:

a) extracting an aliquot of blood from the patient, subjecting the aliquot extracorporeally to at least two

stressors selected from the group consisting of a temperature above or below body temperature, an electromagnetic emission and an oxidative environment; and

b) administering the aliquot of blood treated in step (a) to the patient, wherein the aliquot has a volume sufficient to alleviate said endothelin-related disorder.

2. The method of claim 1 wherein all of the stressors are simultaneously administered to the aliquot.

3. The method of claim 2, wherein the oxidative environment comprises applying an oxidizing agent to the aliquot.

4. The method of claim 3, wherein the oxidizing agent contains ozone gas, and the ozone gas is introduced into the blood aliquot in an amount which does not give rise to excessive levels of cell damage.

5. The method of claim 3, wherein the oxidizing agent comprises a mixture of ozone gas and medical grade oxygen, the ozone gas being contained in the mixture in a concentration of up to about 300  $\mu$ g/ml.

6. The method of claim 5, wherein the ozone gas in the mixture is in a concentration of up to about 30  $\mu$ g/ml.

8. The method of claim 5, wherein the mixture is applied to the aliquot at a flow rate of up to about 0.33 litres/min.

9. The method of claim 8, wherein the mixture is applied to the aliquot at a flow rate of from about 0.21 litres/min to about 0.27 litres/min.

10. The method of claim 2, wherein the electromagnetic emission comprises ultraviolet light having one or more UV-C band wavelengths.

11. The method of claim 2, wherein the temperature stressor is applied so that the temperature of at least part of the aliquot is in the range of from about  $-5^{\circ}$  C. to about  $55^{\circ}$  C.

12. The method of claim 2, wherein the mean temperature of the blood in the aliquot is in the range of from about  $0^{\circ}$  C. to about  $36.5^{\circ}$  C.

13. The method of claim 2, wherein the temperature is in the range of from about  $37^{\circ}$  C. to about  $55^{\circ}$  C.

14. The method of claim 13, wherein the temperature is  $42.5 \pm 1^{\circ}$  C.

15. The method of claim 2, wherein the volume of the aliquot is up to about 400 ml.

16. The method of claim 15, wherein the volume of the aliquot is about 10 ml.

17. The method of claim 2, wherein the aliquot is subjected to the stressors for a period of up to about 60 minutes.

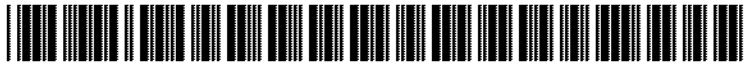
18. The method of claim 17, wherein the aliquot is subjected to the stressors for a period of about 3 minutes.

19. The method of claim 2, wherein the blood is administered to the mammal by a method suitable for delivery selected from the group consisting of intra-arterial injection, intramuscular injection, intravenous injection, subcutaneous injection, intraperitoneal injection, and oral, nasal or rectal administration.

20. The method of claim 2, wherein the endothelin-related disorder is primary pulmonary hypertension.

21. The method of claim 2, wherein the endothelin-related disorder is glaucoma.

22. The method of claim 2, wherein the endothelin-related disorder is excessive angiogenesis.



US 20040101517A1

(19) **United States**

(12) **Patent Application Publication**

(10) **Pub. No.: US 2004/0101517 A1**

**Bolton et al.**

(43) **Pub. Date: May 27, 2004**

(54) **BLOOD BRAIN BARRIER MODULATION  
USING STRESSED AUTOLOGOUS BLOOD  
CELLS**

(30) **Foreign Application Priority Data**

Feb. 1, 2001 (CA) ..... 2,333,494

(76) Inventors: **Anthony E. Bolton**, Bakewell (GB);  
**Arkady Mandel**, North York (CA)

**Publication Classification**

Correspondence Address:

**FOLEY & HARDNER LLP  
THREE PALO ALTO SQUARE  
3000 EL CAMINO REAL  
SUITE 100  
PALO ALTO, CA 94306 (US)**

(51) **Int. Cl.<sup>7</sup>** ..... **A61K 45/00**; C12N 5/08

(52) **U.S. Cl.** ..... **424/93.7**; 435/372

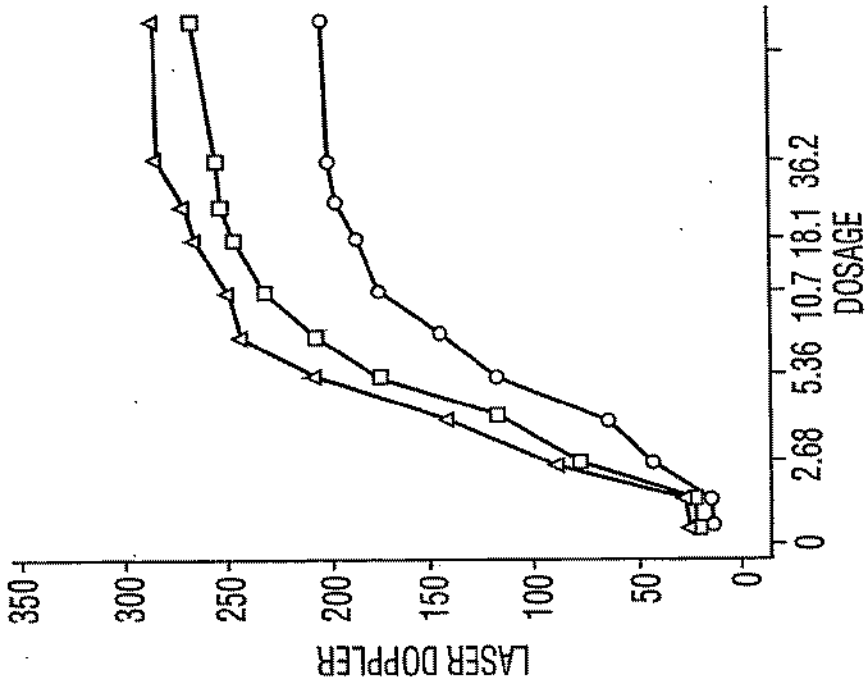
(57) **ABSTRACT**

A method of alleviation, prophylaxis against or preconditioning to hinder the on-set and progression of a neurodegenerative disorder, such as Alzheimer's Disease, Parkinson's Disease or senile dementia, comprises treating a patient suffering from or at risk to contract such a disorder and having impaired endothelial function at the blood vessels, with autologous stressed blood cells, to improve the performance of endothelial function at the blood brain barrier towards restoration of normal endothelial function.

(21) Appl. No.: **10/470,925**

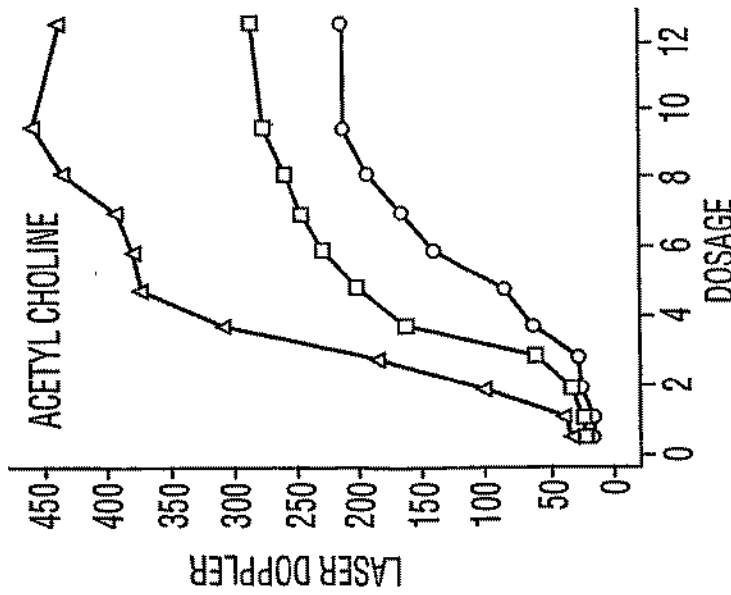
(22) PCT Filed: **Feb. 1, 2002**

(86) PCT No.: **PCT/CA02/00127**



y: VISIT 1=○, VISIT 11=Δ, VISIT 12=□,

FIG. 2

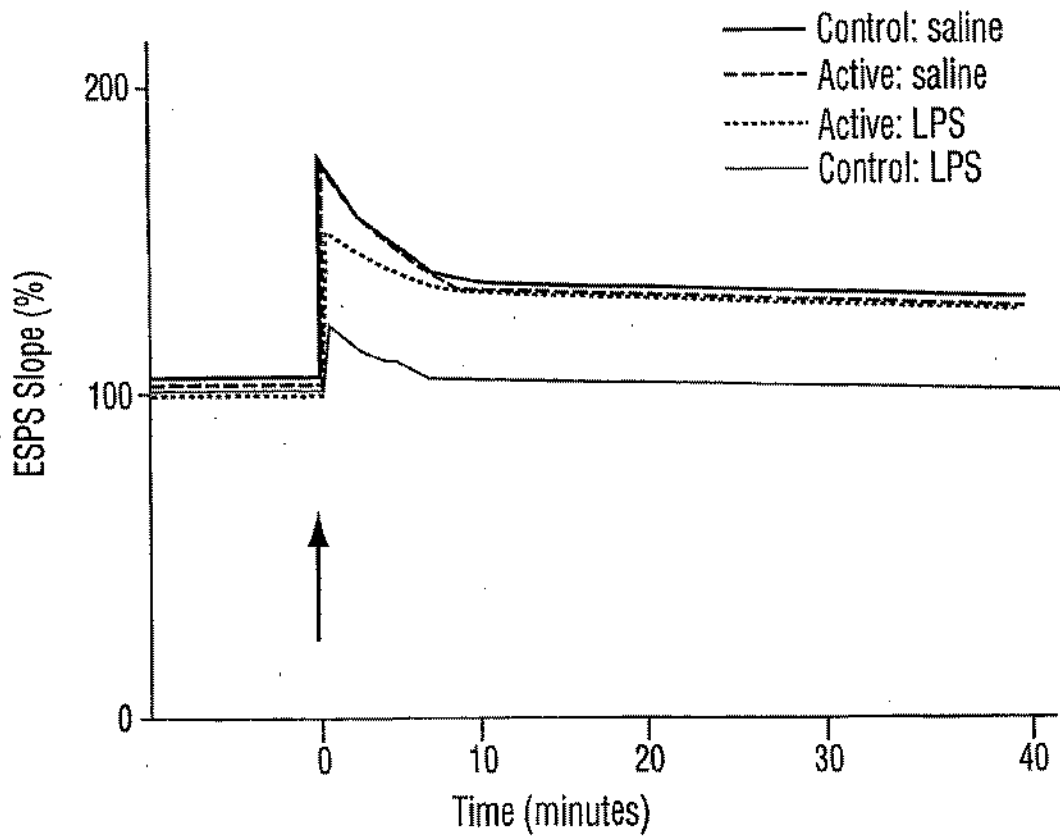


y: VISIT 1=○, VISIT 11=Δ, VISIT 12=□,

FIG. 1



### LTP in Perforant Path-Granule Cell Synapses



**FIG. 3**

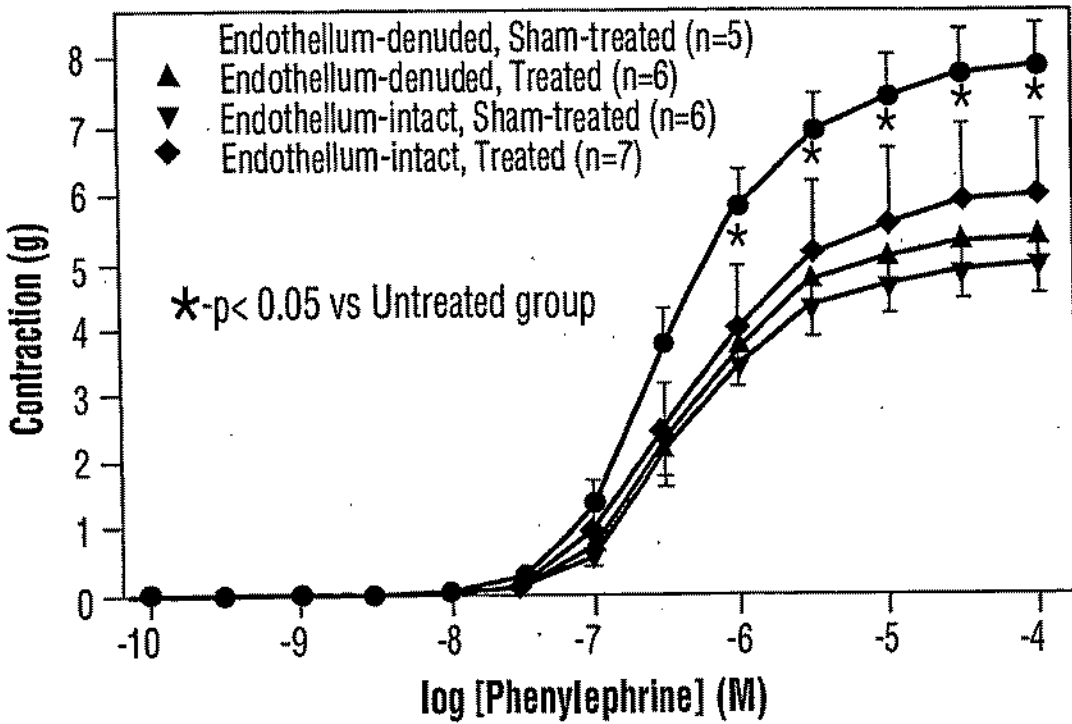


FIG. 4

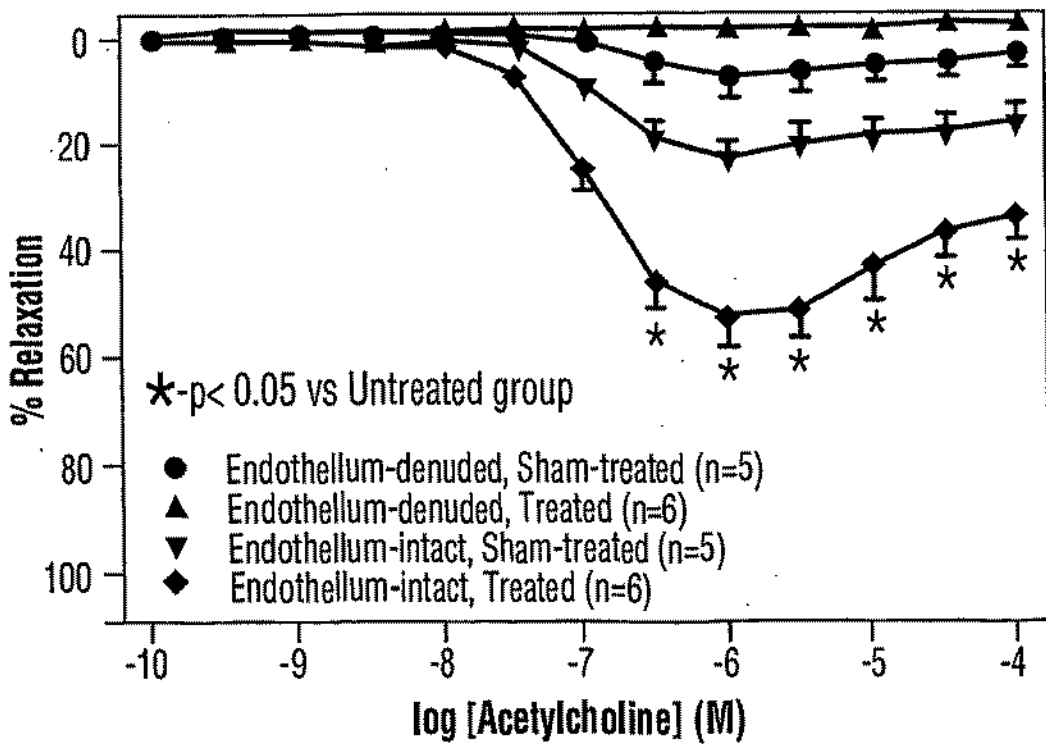


FIG. 5

## BLOOD BRAIN BARRIER MODULATION USING STRESSED AUTOLOGOUS BLOOD CELLS

### FIELD OF THE INVENTION

[0001] This invention relates to medical treatments and pharmaceutical compositions and uses. More particularly, the invention is concerned with neuro-degenerative disorders, their management and treatment.

### BACKGROUND OF THE INVENTION

[0002] Neuro-degenerative disorders such as Alzheimer's Disease, Parkinson's Disease and senile dementia, have recently come to be understood to be associated with inflammatory reactions in the brain, leading to neuronal damage. This suggests that inflammation-causing substances may be breaching the blood brain barrier, which in turn suggests that a patient suffering from a neuro-degenerative disorder may have a compromised blood-brain barrier.

[0003] The so-called "blood-brain barrier" consists essentially of the walls of the blood vessels of the brain. The brain is supplied with blood vessels (arteries, veins, capillaries, etc.), through which blood circulates to fulfill its transporting functions to the brain. The blood vessels have walls through which oxygen and other small molecules can migrate, into the brain cells and tissues. The blood vessel walls have various components including the endothelium and the smooth muscle.

[0004] The endothelium is a cellular structure which lines the blood vessels including blood vessels of the brain, and communicates with the smooth muscle layer of the blood vessel walls. Originally thought to function primarily to protect the blood vessels, the endothelium has more recently been recognized to play a more complex role, e.g. in expressing and secreting vasodilatory and vasoconstrictive components to regulate contraction and relaxation of the blood vessel and thereby play a role in regulating blood flow.

[0005] Until recently, the central nervous system (CNS) has been considered to be an immunologically privileged site to protect it from damage originating, for example, from inflammation arising in the periphery, with the blood-brain barrier restricting the entry of circulating lymphocytes. During inflammatory conditions in the CNS, immune cells immigrate into the CNS and can be detected in the CNS parenchyma and the cerebrospinal fluid. The mechanisms that regulate inflammatory cell recruitment across the blood brain barrier during CNS inflammation have not been characterized. However, endothelial dysfunction and activation may constitute a critical part of a cascade of events leading to increases in blood-brain barrier permeability to non-neural proteins, leading to inflammation and brain tissue damage. Released inflammatory cells may yield deleterious compounds or cytokines that exacerbate the inflammatory damage to metabolically compromised neurons. These inflammatory mechanisms may operate in the pathophysiology of neuro-degenerative diseases in which endothelial factors, inflammation and brain tissue damage are implicated.

[0006] The loss of well-regulated endothelial cell functioning is followed by adverse changes in a variety of physiological systems, such as the expression of adhesion molecules, maintenance of adequate blood vessel tone and

overall homeostasis. In addition, endothelial dysfunction and endothelial mediated vascular inflammation may lead to breach of the blood-brain barrier, and this in turn may produce biochemical derangements that are conducive to production of  $\beta$ -amyloid.

[0007]  $\beta$ -amyloid has recently come to be understood to be one of the causes of inflammatory reactions in the brain leading to neuronal damage. Its presence in the brain is thought to indicate a compromised blood-brain barrier—either a precursor of the protein, the protein itself or cells which secrete it are crossing the blood-brain barrier in patients with neuronal damage, but not in otherwise healthy patients. Gradual accumulation of  $\beta$ -amyloid and perhaps other brain damaging substances from the blood may occur in patients with a compromised blood brain barrier, leading to inflammation, neuronal damage, and a gradual progression in the severity of the damage.

### SUMMARY OF THE INVENTION

[0008] The present invention is based on the discovery that a deficient or malfunctioning endothelium in a patient has a significant, adverse effect on the integrity or permeability (transport properties) of the blood brain barrier. Various substances, naturally present in the blood or introduced into the blood, will cross the blood brain barrier of a patient with a deficient or malfunctioning endothelium, whereas they do not cross the blood brain barrier, at least to any significant extent, when the endothelium is normal. Such substances may include neuronal inflammation-causing proteins carried by the blood, such as  $\beta$ -amyloid or its precursors. Over a period of time, the brain may accumulate quantities of blood borne materials such as pro-inflammatory proteins, or their metabolic products, if there is a defective endothelium at the patient's blood brain barrier. Such a gradual accumulation may underlie the gradual on-set of a neurological disorder and its gradual progression. It is generally accepted that endothelial dysfunction is rare in young patients, and that its prevalence increases with aging.

[0009] Accordingly, the present invention is a method of alleviation, prophylaxis against or preconditioning to hinder the on-set and progression of a neuro-degenerative disorder, such as Alzheimer's Disease, Parkinson's Disease, or senile dementia, which comprises treating a patient suffering from or at risk to contract such a disorder and having impaired endothelial function at the blood vessels, to improve the performance of endothelial function at the blood brain barrier towards restoration of normal endothelial function, by the administration to the patient of autologous blood cells which have been appropriately stressed in vitro. This represents a novel and innovative approach to the management and treatment of neuro-degenerative disorders.

[0010] The present invention also includes a process in which patients are diagnosed for defective endothelial function. Based upon the results of such diagnosis, a population group is selected for endothelial dysfunction contributing to a patient's neurodegenerative disorder or rendering the patient susceptible thereto. The so-selected sub-group is then treated aforesaid.

### BRIEF REFERENCE TO THE DRAWINGS

[0011] FIG. 1 and FIG. 2 of the accompanying drawings are graphical presentations of the results obtained according to Example 1 below, and

[0012] FIG. 3 is a graphical presentation of results obtained according to Example 2 below;

[0013] FIGS. 4 and 5 are graphical presentations of the results of Example 3 below.

#### DESCRIPTION OF THE PREFERRED EMBODIMENTS

[0014] In accordance with preferred embodiments of the invention, a patient is treated to alter a defective endothelium towards normalization of its function by administration to the patient of autologous blood cells which have been extracorporeally stressed by subjection to appropriate amounts of oxidative stress, preferably simultaneously with exposure to ultraviolet radiation and preferably also at an elevated temperature. This process as applied to the alleviation of the symptoms of various autoimmune disorders is fully described in U.S. Pat. No. 5,980,954 Bolton, issued Nov. 9, 1999, the disclosure of which is incorporated herein by reference. Briefly, it involves extracting an aliquot of blood, e.g. 10 cc, from a patient, subjecting the aliquot extracorporeally to oxidative stress e.g. bubbling ozone/oxygen mixture through the aliquot, and simultaneously exposing the aliquot to ultraviolet radiation, at a slightly elevated temperature, e.g. 38.5° C. The stressing treatment causes stressing of the blood cells in the aliquot, to alter their cytokine profile. When these stressed cells are reinjected into the patient, they have an effect on the endothelium and tend to normalize the function of a defective endothelium. In doing so, they alter the transport properties of the blood brain barrier, bringing it back toward a normal function and therefore restoring the blood brain barrier to a condition in which it allows only those blood borne substances intended to cross the blood brain barrier, such as oxygen, nutrients, various hormones and various ions, to cross into the brain tissue and brain cells. The stressed cells, or blood components affected by the stressed cells after re-introduction of the blood aliquot into the patient, acting through the endothelium, have beneficial effects on neurological disorders, from which the patient may be suffering, at least to the extent of hindering the progression thereof, and even effecting substantial alleviation of the symptoms of the disease.

[0015] The source of the stressed blood cells for use in this invention is the patient's own blood, i.e. an aliquot of autologous blood, or a cellular fraction thereof.

[0016] The terms "aliquot", "aliquot of blood" or similar terms used herein include whole blood, separated cellular fractions of the blood including platelets, separated non-cellular fractions of the blood including plasma, plasma components and combinations thereof. Preferably, in human patients, the volume of the aliquot is up to about 400 ml, preferably from about 0.1 to about 100 ml, more preferably from about 1 to about 15 ml, even more preferably from about 8 to about 12 ml, and most preferably about 10 ml. The effect of the stressor or the combination of stressors is to modify the blood, and/or the cellular or non-cellular fractions thereof, contained in the aliquot. The modified aliquot is then re-introduced into the subject's body by any suitable method, most preferably intramuscular injection, but also including subcutaneous injection, intraperitoneal injection, intra-arterial injection, intravenous injection and oral administration.

[0017] According to a preferred process of the present invention, an aliquot of blood is extracted from the human

patient, and the aliquot of blood is treated ex vivo, simultaneously or sequentially, with the aforementioned stressors. Then it is injected back into the same subject. Preferably a combination of both of the aforementioned stressors is used.

[0018] Preferably also, the aliquot of blood is in addition subjected to mechanical stress. Such mechanical stress is suitably that applied to the aliquot of blood by extraction of the blood aliquot through a conventional blood extraction needle, or a substantially equivalent mechanical stress, applied shortly before the other chosen stressors are applied to the blood aliquot. This mechanical stress may be supplemented by the mechanical stress exerted on the blood aliquot by bubbling gases through it, such as ozone/oxygen mixtures, as described below. Optionally also, a temperature stressor may be applied to the blood aliquot, simultaneously or sequentially with the other stressors, i.e. a temperature at, above or below body temperature.

[0019] The optionally applied temperature stressor either warms the aliquot being treated to a temperature above normal body temperature or cools the aliquot below normal body temperature. The temperature is selected so that the temperature stressor does not cause excessive hemolysis in the blood contained in the aliquot and so that, when the treated aliquot is injected into a subject, the desired effect will be achieved, without development of significant adverse side effects. Preferably, the temperature stressor is applied so that the temperature of all or a part of the aliquot is up to about 55° C., and more preferably in the range of from about -5° C. to about 55° C.

[0020] In some preferred embodiments of the invention, the temperature of the aliquot is raised above normal body temperature, such that the mean temperature of the aliquot does not exceed a temperature of about 55° C., more preferably from about 40° C. to about 50° C., even more preferably from about 40° C. to about 44° C., and most preferably about 42.5±1° C.

[0021] In other preferred embodiments, the aliquot is cooled below normal body temperature such that the mean temperature of the aliquot is within the range of from about 4° C. to about 36.5° C., more preferably from about 10° C. to about 30° C., and even more preferably from about 15° C. to about 25° C.

[0022] The oxidative environment stressor can be the application to the aliquot of solid, liquid or gaseous oxidizing agents. Preferably, it involves exposing the aliquot to a mixture of medical grade oxygen and ozone gas, most preferably by applying to the aliquot medical grade oxygen gas having ozone as a component therein. The ozone content of the gas stream and the flow rate of the gas stream are preferably selected such that the amount of ozone introduced to the blood aliquot, either on its own or in combination with one of the other stressors, does not give rise to excessive levels of cell damage, and so that, when the treated aliquot is injected into a subject, the desired effect will be achieved, without development of significant adverse side effects. Suitably, the gas stream has an ozone content of up to about 300 µg/ml, preferably up to about 100 µg/ml, more preferably about 30 µg/ml, even more preferably up to about 20 µg/ml, particularly preferably from about 10 µg/ml to about 20 µg/ml, and most preferably about 14.5±1.0 µg/ml. The gas stream is suitably supplied to the aliquot at a rate of up to about 2.0 litres/min, preferably up to about 0.5 litres/min,

more preferably up to about 0.4 litres/min, even more preferably up to about 0.33 litres/min, and most preferably about  $0.24 \pm 0.024$  litres/min. The lower limit of the flow rate of the gas stream is preferably not lower than 0.01 litres/min, more preferably not lower than 0.1 litres/min, and even more preferably not lower than 0.2 litres/min, all rates at STP.

[0023] The ultraviolet light stressor is suitably applied by irradiating the aliquot under treatment from a source of UV light. Preferred UV sources are UV lamps emitting W-C band wavelengths, i.e. at wavelengths shorter than about 280 nm. Ultraviolet light corresponding to standard UV-A (wavelengths from about 315 to about 400 nm) and UV-B (wavelengths from about 280 to about 315) sources can also be used. As in the case of the oxidative stressor, the UV dose should be selected, on its own or in combination of the other chosen stressor(s), so that excessive amounts of cell damage do not occur, and so that, when the treated aliquot is injected into a subject, the desired effect will be achieved. For example, an appropriate dosage of such UV light, can be obtained from up to eight lamps arranged to be exposed to the sample container holding the aliquot, operated at an intensity to deliver a total UV light energy at 253.7 nm at the surface of the blood of from about 0.025 to about 10 joules/cm<sup>2</sup>, preferably from about 0.1 to about 3.0 joules/cm<sup>2</sup>. Such a treatment, applied in combination with the oxidative environment stressor, provides a modified blood aliquot which is ready for injection into the subject.

[0024] It is preferred to subject the aliquot to the oxidative environment stressor, the UV light stressor and the temperature stressor simultaneously, following the subsection of the aliquot to the mechanical stress, e.g. by extraction of the blood from the patient. Thus, the aliquot may be maintained at a predetermined temperature above or below body temperature while the oxygen/ozone gas mixture is applied thereto and while it is irradiated with ultraviolet light.

[0025] The time for which the aliquot is subjected to the stressors is normally within the time range of from about 0.5 minutes up to about 60 minutes. The time depends to some extent upon the chosen combination of stressors. When UV light is used, the intensity of the UV light may affect the preferred time. The chosen temperature level may also affect the preferred time. When oxidative environment in the form of a gaseous mixture of oxygen and ozone applied to the aliquot is chosen as one of the two stressors, the concentration of the oxidizing agent and the rate at which it is supplied to the aliquot may affect the preferred temperature. Some experimentation, well within the ordinary skill of the art, to establish optimum times maybe necessary on the part of the operator, once the other stressor levels have been set. Under most stressor conditions, preferred times will be in the approximate range of from about 2 to about 5 minutes, more preferably about 3 minutes. The starting blood temperature, and the rate at which it can be warmed or cooled to a predetermined temperature, tends to vary from subject to subject. Warming is suitably by use of one or more infrared lamps placed adjacent to the aliquot container. Other methods of warming can also be adopted.

[0026] As noted, it is preferred to subject the aliquot of blood to a mechanical stressor, as well as the chosen stressor(s) discussed above. Extraction of the blood aliquot from the patient through an injection needle constitutes the most convenient way of obtaining the aliquot for further

extracorporeal treatment, and this extraction procedure imparts a suitable mechanical stress to the blood aliquot. The mechanical stressor may be supplemented by subsequent processing. For example the additional mechanical shear stress caused by bubbling as the oxidative stressor is applied.

[0027] In the practice of the preferred process of the present invention, the blood aliquot may be treated with the heat, UV light and oxidative environment stressors using an apparatus of the type described in aforementioned U.S. Pat. No. 4,968,483 to Mueller. The aliquot is placed in a suitable, sterile container, which is fitted into the machine. A UV-permeable container is used and the UV lamps are switched on for a fixed period before the other stressor is applied, to allow the output of the UV lamps to stabilize. When a temperature stressor is used combination, the UV lamps are typically on while the temperature of the aliquot is adjusted to the predetermined value, e.g.  $42.5 \pm 1^\circ$  C. Four UV lamps are suitably used, placed around the container.

[0028] The above treatment to improve endothelial function and hence exert beneficial effects on neurological disorders may be used in combination with other treatments such as administration of one or more pharmaceuticals which have a beneficial effect on endothelial function. Such pharmaceuticals include angiotensin converting enzyme (ACE) inhibitors, angiotensin II receptor antagonists, statins, pentoxifylline,  $\beta$ -blockers,  $\alpha$ -antagonists, thalidomide and calcium channel blocking drugs.

[0029] Accordingly, another aspect of the present invention, in a preferred embodiment, is the use of stressed autologous blood cells as described above in combination with an effective amount of an ACE inhibitor in preparation of a medicament for the treatment of, or alleviation of the symptoms of, Alzheimer's disease, Parkinson's disease or senile dementia in a mammalian patient suffering therefrom. More preferably, the ACE inhibitor for such use is selected from alacepril, benazepril, captopril, ceronapril, cilazapril, delapril, enalapril, enalaprilat, fosinopril, imidapril, lisinopril, moveltopril, perindopril, quinapril, ramipril, spirapril, temocapril andtrandolapril.

[0030] It is known that ACE inhibitors, commonly prescribed to combat hypertension in patients through their vasodilation activity, act at least in part through action on the patient's endothelium (see for example see Taddei, S. et. al, *Curr Hypertens Rep* 2000 February;2(1): 64-70). A defective endothelium, responsible at least in part for the patients hypertension or other vascular disorder under treatment, is to a degree repaired or restored towards normal function by the action of the appropriate dose of ACE inhibitor. Known, useful ACE inhibitors for the present invention include alacepril, benazepril, captopril, ceronapril, cilazapril, delapril, enalapril, enalaprilat, fosinopril, imidapril, lisinopril, moveltopril, perindopril, quinapril, ramipril, spirapril, temocapril andtrandolapril. The pharmaceutically acceptable salts of these drugs are also useful herein.

[0031] Appropriate dosages of ACE inhibitors for use in the present invention are largely in accordance with those normally administered in connection with treatment of hypertension, and are known to those skilled in the art and available from standard physicians' reference books.

[0032] Also known to have beneficial effects on a dysfunctional endothelium, and therefore potentially useful in

combination with stressed autologous blood cells as described above in treating neurodegenerative diseases such as Alzheimer's disease, Parkinson's disease, multiple sclerosis and senile dementia, according to a preferred embodiment of the invention, are angiotensin II receptor antagonists such as candesartan, eprosartan, irbesartan, losartan and valsartan (see Cheetham, C., O'Driscoll, G., Stanton, K., Taylor, R. and Green, D., *Clin. Sci. (Colch)* Jan 1, 2001;100(1):13-17). The pharmaceutically acceptable salts of these drugs are also useful herein.

[0033] Appropriate dosages of angiotensin II receptor antagonists for use in the present invention are largely in accordance with those normally administered in connection with treatment of hypertension, and are known to those skilled in the art and available from standard physicians' reference books.

[0034] A defectively functioning endothelium of the blood vessels can also be improved towards normal function, with consequent alleviation of neurological degeneration conditions such as Alzheimer's Disease, Parkinson's Disease, multiple sclerosis and senile dementia, by administration to the patient suffering therefrom of a statin drug commonly prescribed as an antihyperlipidemic. Such statin drugs are inhibitors of the enzyme HMG CoA reductase, and are understood to act at least in part through endothelial effects (See Corsini, A., *J. Cardiovasc Pharmacol Ther* 2000 July;5(3):161-75; and Farmer, J. A., *Curr Atheroscler Rep* 2000 May;2(3):208-217).

[0035] Suitable such statin drugs for use in combination with stressed autologous blood cells in accordance with the present invention include atorvastatin, fluvastatin, lovastatin, simvastatin, pravastatin and cerivastatin. The pharmaceutically acceptable salts of these drugs are also useful herein. They can be used for purposes according to the present invention in dosage ranges generally similar to those used for the treatment of hyperlipidemia with these drugs, such doses being known to those skilled in the art and available from standard physicians' reference books. These are, in respect of atorvastatin, simvastatin, lovastatin, fluvastatin and pravastatin, from about 5 mg to about 200 mg daily, for an adult of normal body weight, preferably from about 10-80 mg. In respect of cerivastatin, an entirely synthetic compound, the most appropriate daily dosage is much lower, namely from about 0.1-0.8 mg. In the combination therapy of the invention, and afterwards, these dosages may be reduced. Oral administration of the statin drug, once per day, is most appropriate.

[0036] Another means for improving the function of a defective endothelium of the blood vessels, and hence treating or alleviating the symptoms of a neurological degenerative condition such as Alzheimer's Disease, Parkinson's Disease and senile dementia, is by administration of pentoxifylline to the patient suffering therefrom. Pentoxifylline is a known vasodilator drug, the full chemical of which is 3,7-dihydro-3,7-dimethyl-1-(5-oxohexyl)-1H-purine-2,6-dione. This also exerts its vasodilatory action, at least in part, by effects on the endothelium, tending towards a normalization of the function of a defective endothelium (see Kristova, V., Kriska, M., Babal, P., Djibril, M. N., Slamova, J. and Kurtansky, A., *Physiol Res* 2000;49(1):123-8; and Schratzberger, P., et.al. *Immunopharmacology* 1999 January;41(1):65-75), and is hence useful in combination

with stressed autologous blood cells in the present invention. Appropriate daily dosages of pentoxifylline are generally in accordance with those commonly administered for use of the drug as a vasodilator, and are known to those skilled in the art and available from physicians' reference books.

[0037] Also potentially useful in the present invention are combinations of stressed autologous blood cells with calcium channel blocking drugs of the dihydropyridine type. These are known to exert beneficial effects on the endothelium (see Taddei, S., et.al, *Curr Hypertens Rep* 2000 February;2(1): 64-70), so that they are potentially useful in treating neurodegenerative diseases of the aforementioned type. Accordingly another preferred embodiment of the present invention is use of an effective amount of a dihydropyridine-type calcium channel blocker drug in combination with stressed autologous blood cells as described above in preparation of a medicament for the treatment of, or alleviation of the symptoms of, Alzheimer's disease, Parkinson's disease, or senile dementia in a mammalian patient suffering therefrom. Preferred such drugs are drug is amlodipine, aranidipine, bamidipine, benidipine, cilnidipine, efonidipine, elgodipine, felodipine, isradipine, lacidipine, lercanidipine, manidipine, nicardipine, nifedipine, nilvadipine, nimodipine, nisoldipine or nitrendipine.

[0038] A preferred process according to the present invention involves a step of determining whether a patient suffering from or at high risk of developing a neurodegenerative disorder is likely to benefit from a treatment according to the invention. To evaluate this, and consequently to select sub-populations of patients in need or in potential need of endothelial function improvement in association with neurodegenerative disorder treatment or prophylaxis, one method which can be adopted is a determination of the approximate level of endothelial function in the potential patient.

[0039] The proper functioning, or lack thereof, of the endothelium of a mammalian patient, at a particular location, can be tested by using a method which involves the iontophoretic introduction of acetylcholine through the skin, and measurement of its effects on superficial blood at the chosen location. Detection of impaired endothelial function by this testing means, at one location in a patient, is indicative of endothelial dysfunction elsewhere in the patient, including the blood vessels of the brain. Similarly, effecting improvement of endothelial function at that location, as determined by this methodology, is indicative of systemic endothelial function improvement, including blood vessel endothelium repair.

[0040] Acetylcholine introduced to a blood vessel which has intact, properly functioning endothelium stimulates the production and secretion of nitric oxide by the endothelium, to cause smooth muscle relaxation and vasodilation. This vasodilation can be quantified by measurement of blood flow in the vessel, e.g. by laser Doppler flowmetry. If however the endothelium is defective, the acetylcholine may act directly on the smooth muscle and cause them to contract, with resultant vasoconstriction. Clinical examination of endothelial function based on the effects of acetylcholine proceeds generally according to the methodology described by Chowienzyk et.al., "Impaired endothelium-dependent vasodilation of forearm resistance vessels in hypercholesterolaemia", *The Lancet*, Vol.340, Dec. 12,

1992, p.1430. Briefly, acetylcholine is applied to the skin of the patient and a small electric current is applied across the skin between two adjacent electrodes, one positively charged and one negatively charged (iontophoresis). Acetylcholine passes through the skin with the current, to the superficial blood vessels. There the acetylcholine acts on the endothelial cells to cause vasodilation, or on the smooth muscle cells to cause vasoconstriction, depending on the state of the endothelium. Resultant blood flow is measured by laser Doppler flowmetry.

[0041] This method of diagnosing a patient and determining suitability of a potential patient for treatment or prophylaxis of neurodegenerative disorders is generally described for illustrative purposes in Example 1, given below.

[0042] Another method for diagnosing dysfunctional endothelium, and hence for selecting a population or sub-population of patients for whom the treatment and compositions of the present invention are suitable is based on the process described by Jimenez J. J., et. al., *British Journal of Haematology* 2001 January: 112: 81-90 This method measures the release of microparticles <about 1.5  $\mu\text{m}$  from endothelial cells, more specifically CD31+ and CD51+ endothelial microparticles (EMPs), by flow cytometry using plasma labeled with fluorescein isothiocyanate-conjugated anti-CD31 and anti-CD51 antibodies. Elevation of CD31+ EMP levels in a patient suspected of having a neurodegenerative disease above the level found in normal, healthy individuals (Minagar, A et. al., *Neurology* 2001 May 22; 56(10): 1319-1324), indicates acute injury to the patient's brain blood vessel endothelium. Elevation of CD51+EMP levels indicates chronic injury of endothelium. Either of these elevations indicates suitability of the patient for treatment of neurological disease according to the present invention.

[0043] Other methods of diagnosing dysfunctional endothelium are known in the art and may be used for determining the suitability of a potential patient for treatment or prophylaxis of neurodegenerative disorders as described herein.

#### EXAMPLE 1

[0044] Four patients, human females ranging in age from 15 to 84 years, and all suffering from an endothelium deficiency-related condition (primary Raynaud's phenomenon) were subjected to a course of treatment of autologous stressed blood cells. Treatment was given by skilled, qualified personnel, in a medical hospital facility on an out-patient basis.

[0045] Each treatment administered to the patient involved removing a 10 ml aliquot of the patient's blood, into an apparatus as generally described in aforementioned U.S. Pat. No. 4,968,483, heating the sample to 42.5 degrees C. and exposing it to UV radiation at wavelength 253.7 nm. Upon reaching the required temperature (42.5 C), a gaseous mixture of medical grade oxygen with an ozone content of 12.5 micrograms per ml, at a flow rate of about 60 ml/min (STP) was bubbled through the sample for 3 minutes.

[0046] After the ex vivo treatment of the blood sample had been completed, the sample was injected into the respective patient via the gluteal muscle. Each patient underwent a course of 10 such treatments over a period of 2-4 weeks, the individual treatments being spaced apart by about 1-3 days.

[0047] Subjectively, every patient reported a very significant alleviation of her Raynaud's symptoms, after completion of the course of treatments, indicative of an improvement in endothelial function.

[0048] For each patient, objective measurements of blood flow, before and after the course of treatments, were made by the iontophoretic technique using acetylcholine as previously described. The iontophoretic applications and measurements were made on the patients' forearms. The initial measurements on each patient were taken immediately before the first treatment. The subsequent measurements were all taken one day after the completion of the course of ten treatments, and again on a follow-up basis two or three weeks later (visit 12). One of the four patients was given a second, subsequent course of five further treatments. Blood flow was measured by laser Doppler flowmetry.

[0049] For each measurement, a reservoir containing acetylcholine was mounted on the patient's arm with the acetylcholine in contact with the patient's skin. Electrodes were inserted into the reservoir so that a current of known but variable magnitude could be applied to the reservoir to exert an iontophoretic effect. The dose of acetylcholine applied to the skin is a function of the time of acetylcholine-skin contact and the voltage applied between the electrodes, thereby giving a dose in arbitrary units.

[0050] FIG. 1 presents a graph of observed laser Doppler flow of blood against dosage, in arbitrary units, determined as above, for one representative patient.

[0051] The duration of the iontophoresis was arbitrarily divided into various equal time intervals or epochs. The mean flow at each epoch is plotted against time, with the mean plotted at the mid time point of each epoch. The curve denoted by circles is that obtained from testing conducted before the first treatment, i. on the patient's first visit. As shown, blood flow increases in a generally sigmoidal fashion as the acetyl choline dosage (function of contact time and applied iontophoretic voltage) increases. The curve denoted by triangles is that obtained in a similar manner, on the patient's 11<sup>th</sup> visit, one day after the conclusion of the course of ten treatments. The curve denoted by squares is that obtained on the patient's 12<sup>th</sup> visit, twenty eight days after the 11<sup>th</sup> visit. Effectively, these are dose response curves. A significant increase in blood flow in response to acetyl-choline, indicative of an enhanced endothelial function, after the course of treatment, is evident from these curves.

[0052] All four of the patients treated showed essentially similar results, those presented on FIG. 1 being representative, and from a single patient. FIG. 2 of the accompanying drawings shows similar curves to FIG. 1, but derived from the means of the measured blood flows of all four of the patients. As in the case of the FIG. 1 curves from the one patient, the curves denoted by circles are the mean blood flow values, at various, increasing doses of acetylcholine from the four patients before the first treatment. The curves denoted by triangles are mean values from one day after the conclusion of the course of treatments. The curves denoted by squares are mean values from twenty eight days after the conclusion of the course of treatments. The dosage response trend is clearly apparent from the curves presented as FIG. 2.

[0053] The iontophoresis data obtained from all four patients as described above, was subjected to statistical

analysis, using the data of each of the four patients obtained before any treatment, and the data obtained from all four patients two to three to four weeks after completion of the course of 10 treatments (visit 12).

[0054] As noted above, in obtaining the curves shown on FIG. 1, the mean flow at each epoch is plotted against time, with the mean plotted at the mid time point of each epoch. Since the graphs indicate that the flow increased in a sigmoid fashion, the slope of the increase was calculated, in each case, using the mean flows from the epoch with a curve starting to rise, to the point where the curve started to become asymptotic. The regression analyses used to calculate these slopes all accounted for greater than 85% of the variation, and were therefore considered a very good fit. There was also calculated a total area under the curve (AUC) from the point where the curve started to rise, to epoch 10. The maximum recorded mean flow and the area under the curve during epoch 11 were also analyzed.

[0055] Table 1 summarizes these results. It indicates that the increase in flow in response to acetylcholine was higher post treatment, since the maximum flow, the AUC during the increase and the AUC in epoch 11 were higher post treatment, to a statistically significant extent, even on the basis of four patients (the P value being 0.012, 0.020 and 0.040 respectively). The slope was also greater, but not significantly so.

TABLE 1

SUMMARY OF ANALYSIS OF IONTOPHORESIS DATA								
Drug	Variable	Baseline Before Treatment		Visit 12 After Course of Treatment		Visit 12 Minus Baseline	95% Confidence Interval	P Value From T-Test
		Mean	SD	Mean	SD			
Acetyl Choline	Slope of increase	36.55	17.360	48.1	12.065	12.26	-1.56, 26.08	0.067
Acetyl Choline	Maximum Flow	211.4	40.67	272.3	22.68	60.93	25.96, 95.89	0.012
Acetyl Choline	AUC during increase	80695	24238.1	106708	15247.0	26013	7899, 44127	0.020
Acetyl Choline	AUC in epoch 11	64139	13167.0	83765	6622.3	19626	2106, 37145	0.040

## EXAMPLE 2

[0056] This experiment investigated the effect of pre-administration of stressed autologous blood cells on lipopolysaccharide (LPS) induced inhibition of long-term potentiation (LTP) in the hippocampus, in an animal model. Long-term potentiation is a form of synaptic plasticity and is thought to be the biological substrate for learning and memory.

[0057] The experimental model was inbred Wistar rats, and involves electrophysiological recording of the excitatory post-synaptic potential (EPSP) following tetanic stimulation. The synaptic activity of a specific neuronal pathway in the hippocampus, the perforant pathway, is measured. EPSP is a functional measure of post-synaptic neurotransmitter release.

[0058] The ability of the hippocampus to sustain LTP is impaired in aged rats, stressed rats and following bacterial infection. The latter can be mimicked by intraperitoneal

injection of LPS, which, as well as resulting in impairment of LTP, is also associated with an increase in the levels and expression of the pro-inflammatory cytokine IL-1 $\beta$  in the hippocampus.

[0059] Four groups of eight animals were investigated. Half the animals were administered 0.15 ml of stressed donor rat blood intramuscularly (equivalent to autologous blood in this inbred strain), on days -14, -13, and -1 prior to the experimental procedure. The blood was stressed as follows:

[0060] Whole blood was obtained from inbred Wistar rats, by extraction from a main artery through an injection needle, and treated with an anti-coagulant. An aliquot of this was subjected to the process described below, to obtain treated blood. The remainder was left untreated, for use in control experiments. Since these rats are genetically identical, the administration of the treated blood to others of the group is equivalent to administration of the treated blood to the donor animal.

[0061] To obtain treated blood, the selected aliquot, in a sterile, UV-transmissive container, was treated simultaneously with a gaseous oxygen/ozone mixture and ultraviolet light at elevated temperature using an apparatus as generally described in aforementioned U.S. Pat. No. 4,968, 483 Mueller et.al. Specifically, 12 ml of citrated blood was

transferred to a sterile, low density polyethylene vessel (more specifically, a Vasogen VC7002 Blood Container) for ex vivo treatment with stressors according to the invention. Using an apparatus as described in the aforementioned Mueller patent (more specifically, a Vasogen VC7001 apparatus), the blood was heated to 42.5 $\pm$ 1 $^{\circ}$  C. and at that temperature irradiated with UV light principally at a wavelength of 253.7 nm, while oxygen/ozone gas mixture was bubbled through the blood to provide the oxidative environment and to facilitate exposure of the blood to UV. The constitution of the gas mixture was 14.5 $\pm$ 1.0  $\mu$ g ozone/ml, with the remainder of the mixture comprising medical grade oxygen. The gas mixture was bubbled through the aliquot at a rate of 240 $\pm$ 24 ml/min for a period of 3 minutes.

[0062] Control animals were administered untreated blood. On day 0, the animals were anaesthetized and injected with either saline or LPS (0.1 ml per kg) intraperitoneally, to give four groups:



[0063] 1. Saline, untreated blood;

[0064] 2. LPS, untreated blood;

[0065] 3. Saline, treated blood;

[0066] 4. LPS, treated blood.

[0067] Three hours later, electrodes were inserted and the electrophysiology experiment performed. The rats were then sacrificed by decapitation, the hippocampus and cortex were dissected on ice, sliced and frozen in 10% DMSO. Serum was prepared from the peripheral blood and stored frozen.

[0068] The results are shown graphically on the accompanying FIG. 3. This shows the slope of the EPSP before and after tetanic stimulation (arrow). It is to be noted that, in animals injected with saline (open squares), there is potentiation of the response (EPSP does not return to pre-tetanic baseline over a 40 minute period), whereas in animals injected with LPS (open triangles) there is no potentiation of the response. In stressed cell treated animals given LPS (closed triangles), the LTP is restored to control levels and in saline-injected animals given stressed-cell therapy there is no difference compared to saline-control animals.

[0069] The results of this experiment show that pretreatment of animals with a course of three injections of the treated blood containing stressed cells protects the hippocampus against the loss of LTP resulting from LPS administration.

[0070] The mechanism of this protection relates at least in part to the reduced formation of LPS induced inflammation in the brains of the rats in the experiment, a mechanism that is supported by the data from the use of stressed cell administration to a patient for pre-conditioning against ischemia/reperfusion injury (see U.S. Pat. No. 6,136,308). The stressed cell therapy lowered LPS induced inflammation in the brain and gave improvement in blood brain barrier function even in normal animals, and thus this beneficial effect has the ability to cross the blood brain barrier. Lowered LPS induced inflammation and improvement in the blood brain barrier function present an attractive explanation of the observed beneficial effects of the stressed cell therapy on the endothelium.

### EXAMPLE 3

[0071] Improvement in endothelial function in the arterial system of a mammal, namely Watanabe rabbits, by use of the present invention was demonstrated.

[0072] Two groups of female Watanabe rabbits, 7-8 months old, were selected, 10 animals in each group. Group A was given a course of treatment in which 10 ml of blood was drawn from the ear vein, treated (stressed) with oxygen/ozone, UV light and elevated temperatures simultaneously, under conditions described in Example 2. A 1 ml portion of the stressed blood was reinjected to the same animal via the gluteal muscle. Such treatments took place on days 7, 8 and 20 following reception. Group B had blood withdrawn and reinjected in the same manner and in the same volumes, but the blood was not stressed (sham treatment). After 12 weeks from the last treatment, the animals were sacrificed by overdose of anaesthetic, and the arterial system was flushed with modified Krebs-Heinsleit (KH) solution. The iliac arteries were removed and preserved for in vitro vasoconstriction studies.

[0073] The arterial vessels were cleaned from all the fat and connective tissue, and rings (0.4 cm) were cut from the vessel. Rings, one endothelium denuded and one endothelium intact from each animal, were mounted onto wire stirrups, suspended in organ chambers (Radnoti Glass Technology) filled with oxygenated (95% O<sub>2</sub>/5% CO<sub>2</sub>) KH at 37 degrees C., and connected to force transducers (Harvard Apparatus) to record changes in isometric force. The output from the transducer was amplified, converted to digital signals and collected by Biopac data acquisition system MP100 (Harvard Apparatus). The rings were stretched to and maintained at a preload of 2 g and allowed to equilibrate for 2 hours. During the equilibration period, the buffer was changed every 30 minutes and continuously bubbled with 95% oxygen and 5% carbon dioxide. After equilibration, all aortic rings were exposed to cumulative concentrations of phenylephrine, a potent alpha-agonist ( $1 \times 10^{-10}$  to  $1 \times 10^{-4}$  M) to determine contractile response. Then the rings were contracted with ED<sub>65</sub> of phenylephrine to obtain the maximal contraction, and then exposed to cumulative concentrations of acetylcholine ( $1 \times 10^{-10}$  to  $1 \times 10^4$  M) to observe the relaxation result.

[0074] Vasoreactivity reaction to phenylephrine results are presented graphically on FIG. 4. The reaction of the endothelium-intact sample from the treated animals is significantly different from that of the sham treated animals. On the endothelium denuded samples, there is no significant difference between the treated animals and the sham treated animals.

[0075] FIG. 5 presents graphically the effect of relaxation induced by acetylcholine on the endothelium-intact and the endothelium-denuded iliac artery samples from treated and sham treated rabbits. The endothelium-denuded samples are significantly lower, showing the involvement of the endothelium in the process of the invention, effecting a significant improvement in endothelial function.

[0076] Values presented on FIGS. 4 and 5 are mean—s.e.

[0077] Since the stressed cell therapy as described herein has a beneficial effect on endothelial function, the therapy alone and in combination with other available treatments known to have similar beneficial effects on the endothelium, such as use of the pharmaceuticals as discussed herein, show potential in the treatment of neuro-degenerative disorders such as Alzheimer's Disease, Parkinson's Disease, and senile dementia.

What is claimed is:

1. Use in the preparation of a medicament for alleviation, prophylaxis against or preconditioning to hinder the on-set and progression of a neuro-degenerative disorder in a mammalian patient suffering from or at risk to contract such a disorder, of stressed autologous blood cells, said cells having been stressed by extracorporeal subjection to oxidative stress.

2. Use according to claim 1 wherein the cells have additionally been extracorporeally subjected simultaneously to UV light.

3. Use according to claim 1 or claim 2 wherein the oxidative stressor is exposure to a mixture of medical grade oxygen and ozone gas, with an ozone content up to about 300 µg/ml.

4. Use according to claim 3 wherein the oxygen/ozone gas mixture is bubbled through a suspension of blood cells at a rate of from 0.01-2.0 litres per minute (STP).

5. Use according to claim 4 wherein the suspension of blood cells is whole blood, of a volume from 0.1-100 ml.

6. Use according to any preceding claim wherein the blood cells are additionally subjected to elevated temperature of from 40-50° C., simultaneously with the subjection to oxidative stress.

7. Use according to any preceding claim in combination with administration to the patient of an effective amount of an ACE inhibitor.

8. Use according to claim 7 wherein the ACE inhibitor is selected from alacepril, benazepril, captopril, ceronapril, cilazapril, delapril, enalapril, enalaprilat, fosinopril, imidapril, lisinopril, moxeltopril, perindopril, quinapril, ramipril, spirapril, temocapril and trandolapril.

9. Use according to any of claim 1-6 in combination with administration to the patient of an effective amount of an ACE inhibitor selected from alacepril, benazepril, captopril, ceronapril, cilazapril, delapril, enalapril, enalaprilat, fosinopril, imidapril, lisinopril, moxeltopril, quinapril, ramipril, spirapril, temocapril and trandolapril.

10. Use according to any of claims 1-6 in combination with administration to the patient of an effective amount of an angiotensin II receptor antagonist.

11. Use according to claim 10 wherein the angiotensin II receptor antagonist is selected from candesartan, eprosartan, irbesartan, losartan and valsartan.

12. Use according to any of claims 1-6 in combination with administration to the patient of an effective amount of an effective amount of an inhibitor of the enzyme HMG CoA reductase.

13. Use according to claim 12 wherein the inhibitor of the enzyme HMG CoA reductase is atorvastatin, fluvastatin, lovastatin, simvastatin, pravastatin or cerivastatin.

14. Use according to any of claims 1-6 in combination with administration to the patient of an effective amount of an effective amount of a dihydropyridine-type calcium channel blocker drug.

15. Use according to claim 14 wherein the drug is amlodipine, aranidipine, barnidipine, benidipine, cilnidipine, elonidipine, elgodipine, felodipine, isradipine, lacidipine, lercanidipine, manidipine, nicardipine, nifedipine, nilvadipine, nimodipine, nisoldipine or nitrendipine.

16. A method of treating a patient to alleviate a neurological disorder suffered by the patient, which comprises altering the defective endothelium of the patient towards normalization of its function by administration to the patient of autologous blood cells which have been extracorporeally stressed by subjection to appropriate amounts of oxidative stress.

17. The method of claim 11 wherein the cells have also been stressed by simultaneous exposure to ultraviolet radiation and at an elevated temperature.

18. A method of treating a patient to alleviate a neurological disorder suffered by the patient, which comprises:

diagnosing patients to determine the presence in said patients of defective endothelial function in brain blood vessels of the patients;

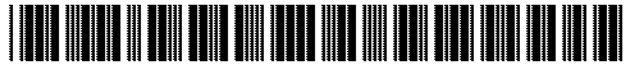
selecting patients diagnosed with defective blood vessel endothelial function, and

administering to the selected patients autologous blood cells which have been extracorporeally stressed by subjection to appropriate amounts of oxidative stress.

19. The process of claim 18 wherein the autologous blood cells have additionally been stressed by simultaneous extracorporeal subjection to UV light.

20. Method according to claim 18 or claim 19 wherein the patient is additionally treated by administration of an ACE inhibitor, an angiotensin II receptor antagonist, an inhibitor of HMG CoA reductase, a dihydropyridine calcium channel blocker or pentoxifylline.

\* \* \* \* \*



US006733748B2

(12) **United States Patent**  
**Spaner**

(10) **Patent No.:** **US 6,733,748 B2**  
(45) **Date of Patent:** **May 11, 2004**

(54) **CHRONIC LYMPHOCYTIC LEUKEMIA TREATMENT**

(75) **Inventor:** **David Elliott Spaner, Toronto (CA)**

(73) **Assignee:** **Vasogen Ireland Limited, Shannon (IE)**

(\*) **Notice:** Subject to any disclaimer, the term of this patent is extended or adjusted under 35 U.S.C. 154(b) by 0 days.

(21) **Appl. No.:** **09/999,850**

(22) **Filed:** **Oct. 25, 2001**

(65) **Prior Publication Data**

US 2002/0090358 A1 Jul. 11, 2002

(30) **Foreign Application Priority Data**

Oct. 25, 2000 (CA) ..... 2324199

(51) **Int. Cl.<sup>7</sup>** ..... **A01N 65/00; A23K 1/17; A61K 1/18**

(52) **U.S. Cl.** ..... **424/93.7; 424/442; 424/439**

(58) **Field of Search** ..... **424/93.7, 442, 424/439**

(56) **References Cited**

**FOREIGN PATENT DOCUMENTS**

WO	96/40214	12/1996
WO	98/07436	2/1998
WO	99/24078	5/1999
WO	00/06703	2/2000
WO	00/06703	* 2/2000
WO	00/41705	7/2000
WO	01/55348	8/2001

\* cited by examiner

*Primary Examiner*—Brenda Brumback

*Assistant Examiner*—Randall Winston

(74) *Attorney, Agent, or Firm*—Swiss Law Group

(57) **ABSTRACT**

Chronic lymphocytic leukemia (CLL) in a patient is treated by administering to the patient oxidatively stressed CLL cells. The CLL cells are oxidatively stressed extracorporeally, e.g. by subjection to oxygen/ozone mixtures, and preferably are simultaneously subjected to other stressors such as UV light. Preferably also, the CLL cells are autologous, and are contained in an aliquot of the patient's blood at the time of subjection to stressing.

**19 Claims, No Drawings**

## CHRONIC LYMPHOCYTIC LEUKEMIA TREATMENT

### CROSS REFERENCE TO RELATED APPLICATIONS

This application claims the benefit of Canadian Application Serial Number 2,324,199, filed Oct. 25, 2000, which is incorporated by reference in its entirety.

### FIELD OF THE INVENTION

This invention relates to leukemia alleviation, and to processes and cellular compositions useful therein. More specifically, it relates to compositions and processes for alleviating chronic lymphocytic leukemia in mammalian patients, especially humans, and to processes for preparing such compositions.

### BACKGROUND OF THE INVENTION

Chronic lymphocytic leukemia (hereinafter CLL) is one of the four major types of leukemia encountered by humans, the others being acute lymphocytic leukemia, acute myeloid leukemia and chronic myeloid leukemia. CLL is most commonly encountered in patients over the age of sixty. It has a gradual onset, and may not cause the patient discomfort or pain for several years. It is characterized by a large number of cancerous mature lymphocytes and enlarged lymph nodes. Cancerous cells crowd out the normal cells in the bone marrow and lymph nodes. Anemia develops in the patient and the number of normal white cells and platelets in the patient's blood decreases, whereas the total white cell count increases due to the proliferation of abnormal white cells. The level and activity of antibodies also decrease. As a result, the patient's immune system becomes compromised. It is more common for CLL sufferers to die from consequences of the compromised immune system, e.g. infections, than from the CLL itself.

The most common type of CLL is a B cell leukemia, and the malignant cell of origin is a CD5+B cell, i.e. a B cell expressing the marker CD5.

Clinical stage of CLL, characterized in the staging systems of Rai (stages 0-IV) and Binet (stages A-C), remains the strongest predictor of survival in CLL patients. Both systems are based on the amount of involved lymphoid tissue and the presence of anemia and/or thrombocytopenia. In general, patients with later stages have a significantly worse prognosis and a shorter survival. Patients with Rai stage IV or Binet stage C have a median survival of only 1.5 to 2 years.

Chemotherapy (initially with alkylating agents such as chlorambucil and subsequently with fludarabine) is the standard treatment for CLL. A patient diagnosed with CLL is normally monitored by tracking the white cell count in the blood. Chemotherapy is not instituted until the patient starts to suffer symptoms such as fatigue, weight loss, fevers or pain as a result of the progression of the CLL. However, CLL is not curable with conventional methods of chemotherapy, even though initial response rates are high. The toxicities associated with the use of chemotherapy are well known and include nausea and myelosuppression with a risk of developing serious infections. Moreover, subsequent responses become inexorably short-lived, likely because drug-resistant tumor cells are selected by the use of cytotoxic agents.

Accordingly, it is an object of the present invention to provide novel procedures and compositions for alleviation of CLL in mammalian patients.

It is a further object of the invention to provide procedures and compositions which, on suitable administration to a CLL suffering patient, will significantly postpone the need for subjecting the patient to chemotherapy.

### SUMMARY OF THE INVENTION

According to the present invention in its broad aspects, CLL in a mammalian patient is alleviated by administering to the patient oxidatively stressed CLL malignant cells. The source of the CLL malignant cells may be the mammalian patient himself or herself (e.g. a withdrawn blood sample from the patient), a compatible mammalian donor (e.g. a withdrawn blood sample from another, compatible CLL-suffering patient), or a cultured cell line of CLL malignant cells. Subjecting of the CLL malignant cells to oxidative stress takes place in vitro. The oxidatively stressed CLL cells thus obtained are administered to the patient to result in an alleviation of the patient's CLL.

According to a preferred aspect of the present invention, CLL in a mammalian patient suffering therefrom is significantly alleviated by administering to the patient oxidatively stressed blood cells, including oxidatively stressed CLL malignant cells, obtained from the patient and subjected to oxidative stress in vitro and then reintroduced into the patient. The procedure thus involves extracting an appropriate quantity of blood containing CLL cells from the CLL patient, treating the blood or a selected portion of it extracorporeally with an oxidative stressor, and reintroducing it into the same patient. The result, after one or more of such treatments, is a significant alleviation of the patient's CLL condition, as indicated in a reduced white blood cell proliferation and a reduced swelling of lymph nodes of the patient.

Thus from one aspect, the present invention provides a process for treating a CLL suffering patient for alleviation of CLL, which comprises extracting an aliquot of blood containing CLL cells from the patient, subjecting at least a portion of the extracted blood cells extracorporeally to appropriate oxidative stress, and re-introducing the oxidatively-stressed material into the patient.

Another aspect of the present invention is oxidatively stressed mammalian CLL cells, useful for introduction into a mammalian patient suffering from CLL to alleviate the patient's CLL.

A further aspect of the present invention is the use in preparation of a medicament active against CLL in a mammalian patient, of oxidatively stressed autologous blood or blood fractions, including oxidatively stressed autologous malignant CLL cells.

Another aspect of this invention is a composition comprising stressed CLL cells. The cells may be oxidatively stressed and may further be autologous CLL cells.

While it is not intended that this invention should be limited to any particular mode of action or theory of mechanism or performance, it is postulated that appropriately oxidatively stressed blood cells activate the regulatory immune T cells controlling the CD5+B cells in the patient's blood, including the malignant CD5+B cells. The oxidatively stressed cells, on reintroduction into the CLL patient, are believed to activate certain T cells present in the patient's blood which then down-regulate the malignant CD5+B cells by acting directly on them or by secreting cytokines which then act on them. In any event, the result is a significant reduction in the rate of proliferation of the malignant CD5+B cells in the CLL patient and a consequent alleviation of the CLL condition and its symptoms.

### DESCRIPTION OF THE PREFERRED EMBODIMENTS

A preferred embodiment of the present invention subjects the blood cells, or the appropriate fraction of them including

the CLL cells, to electromagnetic emission radiation as well as oxidative stress, either simultaneously or sequentially. Optionally also, a temperature stressor may be applied to the cells, simultaneously or sequentially with the oxidative stressor and the electromagnetic emission stressor, i.e. a temperature at, above or below body temperature. An aliquot of blood is drawn from the CLL patient, of volume up to about 400 ml, preferably from about 0.1 to 100 ml, more preferably from about 1 to about 15 ml, even more preferably from about 8 to about 12 ml. Either the whole blood is subjected to the stressor(s), or an appropriate cellular fraction thereof containing the CLL malignant B cell fraction is separated by known methods and subjected to the aforementioned stressor(s). The stressed cells are then reintroduced into the CLL patient from whom the original aliquot was drawn. The term "aliquot" as used herein refers to the sample subjected to the stressors; and embraces both the originally extracted whole blood and any fraction thereof subjected to stressors, before or after separation.

The modified aliquot is re-introduced into the patient's body by any suitable method, most preferably intramuscular injection, but also including subcutaneous injection, intraperitoneal injection, intra-arterial injection, intravenous injection and oral administration. Accordingly, the composition may optionally include a pharmaceutically acceptable excipient, such as sterile physiological saline.

Preferably also, the aliquot of blood is in addition subjected to mechanical stress. Such mechanical stress is suitably that applied to the aliquot of blood by extraction of the blood aliquot through a conventional blood extraction needle, or a substantially equivalent mechanical stress, applied shortly before the other chosen stressors are applied to the blood aliquot. This mechanical stress may be supplemented by the mechanical stress exerted on the blood aliquot by bubbling gases through it, such as ozone/oxygen mixtures, as described below.

The optionally applied temperature stressor either warms the aliquot being treated to a temperature above normal body temperature or cools the aliquot below normal body temperature. The temperature is selected so that the temperature stressor does not cause excessive hemolysis in the blood contained in the aliquot and so that, when the treated aliquot is injected into a subject, the desired effect will be achieved. Preferably, the temperature stressor is applied so that the temperature of all or a part of the aliquot is up to about 55° C., and more preferably in the range of from about -5° C. to about 55° C.

In some preferred embodiments of the invention, the temperature of the aliquot is raised above normal body temperature, such that the mean temperature of the aliquot does not exceed a temperature of about 55° C., more preferably from about 40° C. to about 50° C., even more preferably from about 40° C. to about 44° C., and most preferably about 42.5±1° C.

In other preferred embodiments, the aliquot is cooled below normal body temperature such that the mean temperature of the aliquot is within the range of from about 4° C. to about 36.5° C., more preferably from about 10° C. to about 30° C., and even more preferably from about 15° C. to about 25° C.

The oxidative environment stressor can be the application to the aliquot of solid, liquid or gaseous oxidizing agents, including peroxides such as hydrogen peroxide. Preferably, it involves exposing the aliquot to a mixture of medical grade oxygen and ozone gas, most preferably by applying to the aliquot medical grade oxygen gas having ozone as a

component therein. The ozone content of the gas stream and the flow rate of the gas stream are preferably selected such that the amount of ozone introduced to the blood aliquot, either on its own or in combination with one of the other stressors, does not give rise to excessive levels of cell damage, and so that, when the treated aliquot is injected into a subject, the desired effect will be achieved. Suitably, the gas stream has an ozone content of up to about 300 µg/ml, preferably up to about 100 µg/ml, more preferably about 30 µg/ml, even more preferably up to about 20 µg/ml, particularly preferably from about 10 µg/ml to about 20 µg/ml, and most preferably about 14.5±1.0 µg/ml. The gas stream is suitably supplied to the aliquot at a rate of up to about 2.0 liters/min, preferably up to about 0.5 liters/min, more preferably up to about 0.4 liters/min, even more preferably up to about 0.33 liters/min, and most preferably about 0.2±0.025 liters/min. The lower limit of the flow rate of the gas stream is preferably not lower than 0.01 liters/min, more preferably not lower than 0.1 liters/min. Preferably the amount of ozone introduced to the blood does not exceed about 300 µg/ml of blood in the aliquot.

The electromagnetic emission stressor is suitably applied by irradiating the aliquot under treatment from a source of electromagnetic emission while the aliquot is maintained at the aforementioned temperature and while the oxygen/ozone gaseous mixture is being bubbled through the aliquot. Preferred electromagnetic emissions are selected from photonic radiation, more preferably UV, visible and infrared light, and even more preferably UV light. The most preferred UV sources are UV lamps emitting UV-C band wavelengths, i.e. at wavelengths shorter than about 280 nm. Ultraviolet light corresponding to standard UV-A (wavelengths from about 315 to about 400 nm) and UV-B (wavelengths from about 280 to about 315) sources can also be used. As in the case of the oxidative stressor, the UV dose should be selected, on its own or in combination of the other chosen stressor(s), so that excessive amounts of cell damage do not occur, and so that, when the treated aliquot is injected into a subject, the desired effect will be achieved. For example, an appropriate dosage of such UV light, can be obtained from lamps with a power output of from about 15 to about 25 watts arranged to surround the sample container holding the aliquot, each lamp providing an intensity, at a distance of 1 meter, of from about 45 to 65 mW/cm<sup>2</sup>. Up to eight such lamps, surrounding the sample container holding the aliquot, with a combined output at 253.7 nm of 15 to 25 watts, operated at an intensity to deliver a total UV light energy at 253.7 nm at the surface of the blood of from about 0.025 to about 10 joules/cm<sup>2</sup>, preferably from about 0.1 to about 3.0 joules/cm<sup>2</sup> may advantageously be used. Such a treatment, applied in combination with the oxidative environment stressor, provides a modified blood aliquot which is ready for injection into the subject.

It is preferred to subject the aliquot to the oxidative environment stressor, the UV light stressor and the temperature stressor simultaneously, following the subsection of the aliquot to the mechanical stress, e.g. by extraction of the blood from the patient. Thus, the aliquot may be maintained at a predetermined temperature above or below body temperature while the oxygen/ozone gas mixture is applied thereto and while it is irradiated with ultraviolet light.

The time for which the aliquot is subjected to the stressors is normally within the time range of from about 0.5 minutes up to about 60 minutes. The time depends to some extent upon the chosen combination of stressors. When UV light is used, the intensity of the UV light may affect the preferred time. The chosen temperature level may also affect the

preferred time. When the oxidative environment in the form of a gaseous mixture of oxygen and ozone applied to the aliquot is chosen as one of the two stressors, the concentration of the oxidizing agent and the rate at which it is supplied to the aliquot may affect the preferred temperature. Some experimentation to establish optimum times may be necessary on the part of the operator, once the other stressor levels have been set. Under most stressor conditions, preferred times will be in the approximate range of from about 2 to about 5 minutes, more preferably about 3 minutes. The starting aliquot temperature, and the rate at which it can be warmed or cooled to a predetermined temperature, tends to vary from subject to subject. Warming is suitably by use of one or more infrared lamps placed adjacent to the aliquot container. Other methods of warming can also be adopted.

As noted, it is preferred to subject the aliquot of blood to a mechanical stressor, as well as the chosen stressor(s) discussed above. Extraction of the blood aliquot from the patient through a hypodermic needle constitutes the most convenient way of obtaining the aliquot for further extracorporeal treatment, and this extraction procedure imparts a suitable mechanical stress to the blood aliquot. The mechanical stressor may be supplemented by subsequent processing, for example the additional mechanical shear stress caused by bubbling as the oxidative stressor is applied.

In the practice of the preferred process of the present invention, the aliquot may be treated with the heat, UV light and oxidative environment stressors using an apparatus of the type described in U.S. Pat. No. 4,968,483 to Mueller. The aliquot is placed in a suitable, sterile container, which is fitted into the machine. A UV-permeable container is used and the UV lamps are switched on for a fixed period before the other stressor is applied, to allow the output of the UV lamps to stabilize. When a temperature stressor is used in the combination, the UV lamps are typically on while the temperature of the aliquot is adjusted to the predetermined value, e.g.  $42.5 \pm 1^\circ \text{C}$ . Four UV lamps are suitably used, placed around the container.

In the preferred method of the invention, a mammalian patient is given one or more courses of treatments, each course of treatment comprising the administration to a mammalian subject of one or more (e.g. one to six) blood originating aliquots modified as disclosed above. The treatment may be administered daily, but no more than one treatment should be administered to the subject per day.

Although it may be sufficient to administer only one course of treatment as described above to the subject, it may be preferred in some circumstances to administer more than one treatment or course of treatment, or to follow the above-described course of treatment by periodic "booster" treatments, if necessary, to maintain the desired effects of the present invention. There may be a substantial interval between individual treatments or courses of treatment. For example, it may be preferred to administer booster treatments at intervals of 1 week, 1 month, 3 months or 6 months or other appropriate periods following the initial treatment or course of treatment, depending upon the condition of the individual patient and the progression or remission of the CLL. Regular periodic monitoring of the patients undergoing the treatment according to the invention is contemplated, with repeats of the treatment or course of treatment as indicated by the patient's condition and as determined by the attending physician.

The process of the present invention is particularly indicated for CLL patients whose condition shows signs of accelerated progression to the point where chemotherapy

would normally be instituted. Patients may be selected for treatment based upon several criteria. For example, patients having a CLL cell count in the blood of from about 20 million—100 million CLL cells per milliliter of blood are preferred candidates for the treatment. Normally, however, progression of CLL after diagnosis is simply monitored by determining the white blood cell count of a patient. A normal healthy patient has a white blood cell count of about  $10 \times 10^6$  (i.e.  $10 \times 10^6$  white cells per ml of blood), whereas a CLL patient has elevated white blood cell counts. As the CLL condition progresses, the patient's white blood cell count increases, mainly due to the proliferation of the malignant CD5+B cells. When the patient's white blood cell count reaches the approximate range  $30 \times 10^6$  to  $100 \times 10^6$ , institution of chemotherapy may be indicated. This is the indicator for the institution of the process of the present invention, in its preferred applications, as a means of forestalling or at least delaying the application of chemotherapy to the patient, with all its undesirable accompanying effects.

Patients may be selected for treatment with the methods and processes of this invention. An assessment by an attending clinician will determine their suitability, but normally it will be a patient who has previously tested positive for CLL, has been monitored for some time without evidencing an increase in white cell count, but who has, in the previous 1–2 months prior to test evidenced a white blood cell count increase into the  $30 \times 10^6$  to  $100 \times 10^6$  approximate range.

The beneficial effects of the process of the present invention, as with most leukemia treatments, vary widely in efficacy between individual patients. Some patients show an immediate and long lasting effect. Others show an immediate effect which wears off over time, but which can be re-effected by undertaking a further course of treatments according to the invention. In others, the immediate effect wears off, and apparently is not so re-effected. In any event, the need for the patient to undergo chemotherapy treatments is either obviated or delayed in substantially all cases. Treatment according to the invention can also beneficially follow or even accompany chemotherapy.

The invention will be further described, for illustrative purposes, with reference to specific examples of clinical application of the processes and products of specifically preferred embodiments of the invention.

#### EXAMPLE 1

An elderly male patient had been diagnosed with CLL three years earlier, and had been continuously monitored by physicians since that time, with a view to instituting chemotherapy treatments when the condition deteriorated to the appropriate extent. In the eight-month period leading up to the treatments in accordance with the invention, the patient's white blood cell count had increased from 30 to 70, indicating an imminent need to institute chemotherapy. The patient also exhibited significantly swollen lymph nodes.

The patient was given a course of treatments in accordance with the invention. Each treatment involved withdrawing a 10 ml aliquot of blood from the patient via venal puncture, subjecting the whole blood aliquot, in a sterile UV-transparent container and in the presence of anticoagulant, to simultaneous ozone-oxygen bubbling and UV radiation exposure at elevated temperature, in an apparatus essentially as described in aforementioned U.S. Pat. No. 4,968,483. The treated blood was re-administered to the patient by injection into the gluteal muscle.

The temperature of the blood aliquot in the apparatus was initially raised to  $42.5^\circ \text{C}$ . and held steady at that level. The

constitution of the gas mixture was 14–15 mcg/ml ozone/oxygen, fed through the aliquot at a rate of about 200 mls/minute, for three minutes. The UV radiation had a wavelength of 253.7 nm.

After a course of 6 such treatments, administered over three weeks with a two or three-day interval between each treatment, a favorable response was noted. Instead of a continuing increase in white cell count, the patient exhibited a decrease, from 70 to 61. There was also a 50% decrease in peripheral adenopathy. The treatments were well tolerated and no significant side effects have been reported by the patient.

#### EXAMPLE 2

Following the protocol described in Example 1, the following patients have been treated.

A 55-year old man suffering from CLL and diabetes was treated. The increase in his white cell count was arrested, an effect which has lasted one month since the end of treatment.

A 50-year old man suffering from CLL was treated. His white blood cell count dropped from 30 to 15. This lower level has been maintained for at least one month after the conclusion of treatment.

A 50-year old woman suffering from CLL was treated. She had been treated previously for CLL by chemotherapy using Chlorambucil. Her condition had relapsed and the Chlorambucil was no longer effective. After treatment with the above protocol her white blood cell count was stabilized.

A 60-year old man with CLL and heart problems was treated. His white cell count of 30 was stabilized by the course of treatment.

What is claimed is:

1. A method for treating Chronic Lymphocytic Leukemia (CLL) in a patient in need thereof, which comprises removing an aliquot of blood containing CLL cells from the patient, subjecting at least a portion of the removed blood aliquot extracorporeally to appropriate oxidative stress, wherein the oxidative stress comprises application of an effective concentration of an oxidizing agent to the CLL cells and re-introducing at least a portion of the oxidatively stressed aliquot into the patient.

2. A method of claim 1, wherein the oxidatively stressed aliquot includes malignant CLL cells.

3. The method of claim 2, wherein the cells are further subjected to UV radiation.

4. The method of claim 1, wherein the aliquot of blood has a CLL cell content of from about 20 million to about 100 million cells per ml of blood.

5. The method of claim 1, wherein the aliquot of blood has a white blood cell count of from about  $30 \times 10^6$  to about  $100 \times 10^6$ .

6. The method of claim 1, wherein oxidizing agent comprises ozone gas, and the ozone gas is introduced to the CLL cells in an amount which does not give rise to excessive levels of cell damage.

7. The method of claim 1, wherein the oxidizing agent comprises a mixture of ozone gas and medical grade oxygen, the ozone gas being contained in the mixture in a concentration of up to about 300  $\mu\text{g/ml}$ .

8. The method of claim 6, wherein the ozone gas is contained in the mixture in a concentration of up to about 30  $\mu\text{g/ml}$ .

9. The method of claim 6, wherein the ozone gas is contained in the mixture in a concentration of from about 13.5  $\mu\text{g/ml}$  to about 15.5  $\mu\text{g/ml}$ .

10. The method of claim 7, wherein the mixture is applied to the CLL cells at a flow rate of up to 0.33 liters/min.

11. The method of claim 7, wherein the mixture is applied to the CLL cells at a flow rate of from about 0.21 liters/min to about 0.27 liters/min.

12. The method of claim 3, wherein the UV radiation comprises UV light having one or more UV-C band wavelengths.

13. The method of claim 1, further comprising applying temperature stressor to the CLL cells such that the temperature to which the CLL cells are cooled or heated is a temperature which does not result in substantial lysis of the CLL cells.

14. The method of claim 13, wherein the temperature stressor is applied so that the temperature of at least part of the CLL cells is in the range of from about  $-5^\circ\text{C}$ . to about  $55^\circ\text{C}$ .

15. The method of claim 13, wherein the mean temperature of the CLL cells is in the range of from about  $37^\circ\text{C}$ . to about  $44^\circ\text{C}$ .

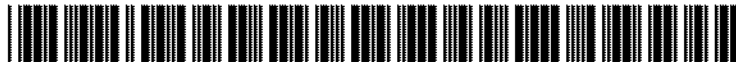
16. The method of claim 14, wherein the temperature of the CLL cells is in the range of from about  $37^\circ\text{C}$ . to about  $55^\circ\text{C}$ .

17. The method of claim 16, wherein the temperature of the CLL cells is  $42.5 \pm 1^\circ\text{C}$ .

18. The method of claim 1, wherein the CLL cells are subjected to oxidative stress for a period of up to about 60 minutes.

19. The method of claim 18, wherein the CLL cells are subjected to oxidative stress for a period of about 3 minutes.

\* \* \* \* \*



US 20080138432A1

(19) **United States**

(12) **Patent Application Publication**  
**Mandel et al.**

(10) **Pub. No.: US 2008/0138432 A1**

(43) **Pub. Date: Jun. 12, 2008**

(54) **ACUTE INFLAMMATORY CONDITION TREATMENT**

(75) Inventors: **Arkady Mandel**, Mississauga (CA); **Anthony E. Bolton**, Dublin (IE)

Correspondence Address:  
**FOLEY & LARDNER LLP**  
**975 PAGE MILL ROAD**  
**PALO ALTO, CA 94304**

(73) Assignee: **Vasogen Ireland Limited**

(21) Appl. No.: **11/632,865**

(22) PCT Filed: **Jul. 18, 2005**

(86) PCT No.: **PCT/CA05/01128**

§ 371 (c)(1),  
(2), (4) Date: **Aug. 16, 2007**

**Related U.S. Application Data**

(60) Provisional application No. 60/589,947, filed on Jul. 20, 2004.

**Publication Classification**

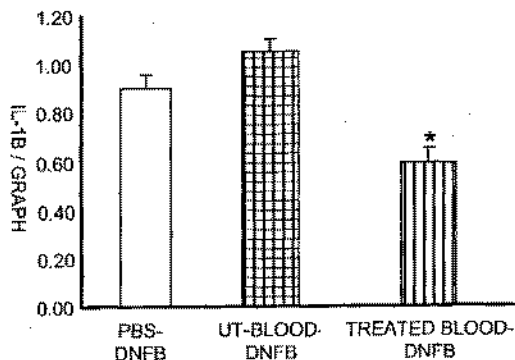
(51) **Int. Cl.**  
*A61K 35/14* (2006.01)  
*A61P 29/00* (2006.01)

(52) **U.S. Cl.** ..... **424/529**

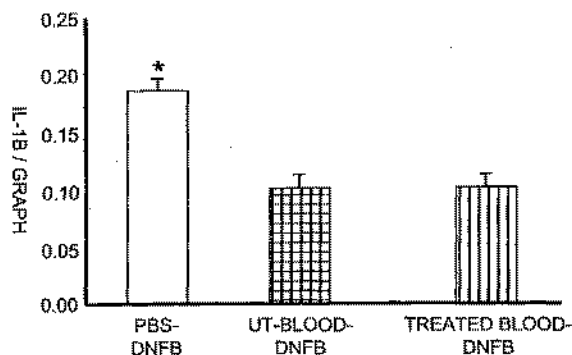
(57) **ABSTRACT**

This invention provides a method for prophylaxis or treatment of an acute inflammatory disorder, comprising administering to a patient an aliquot of the patient's blood extracted from the patient and treated ex vivo with at least two stressors selected from the group consisting of an oxidizing agent, an electromagnetic emission and elevated temperature.

**IL-1b PROFILE AT 12HRS  
IN THE DRAINING LYMPH NODE - ICD**



**IL-1b PROFILE AT 24HRS  
IN THE DRAINING LYMPH NODE - ICD**





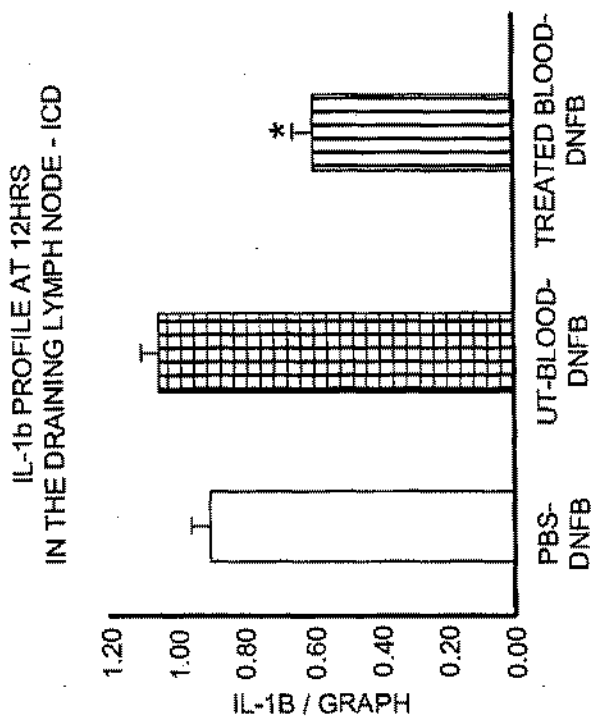
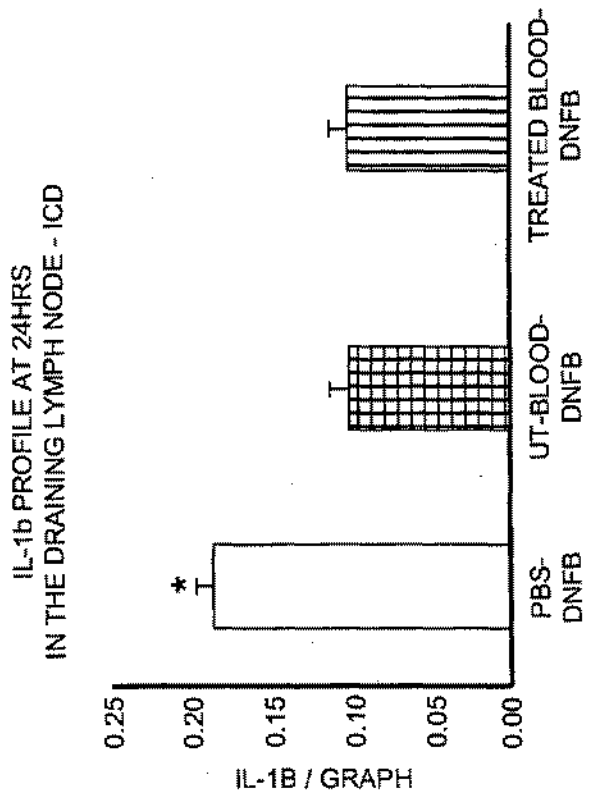


FIG. 1

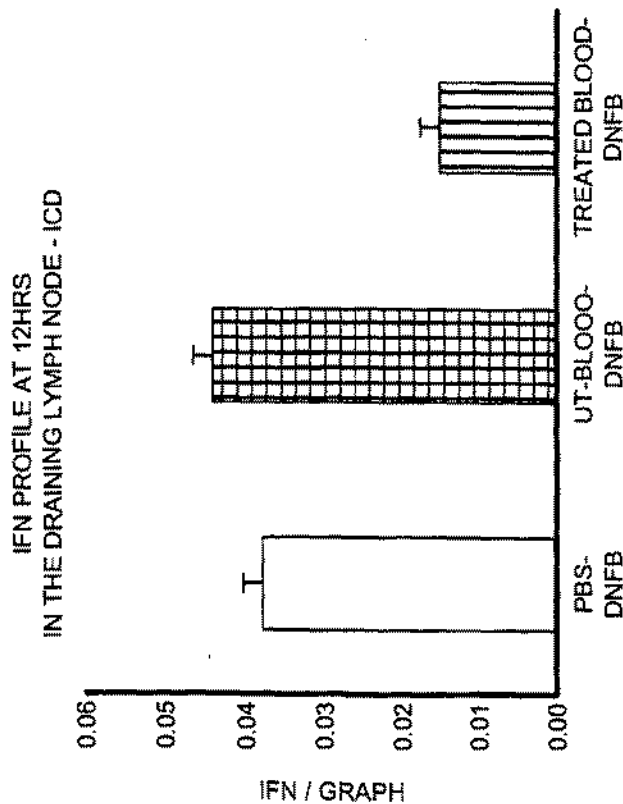
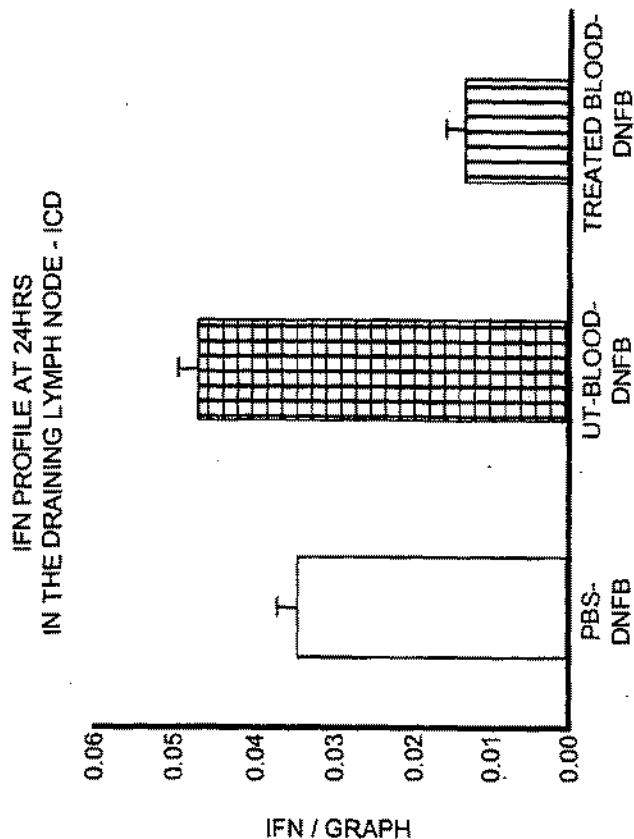
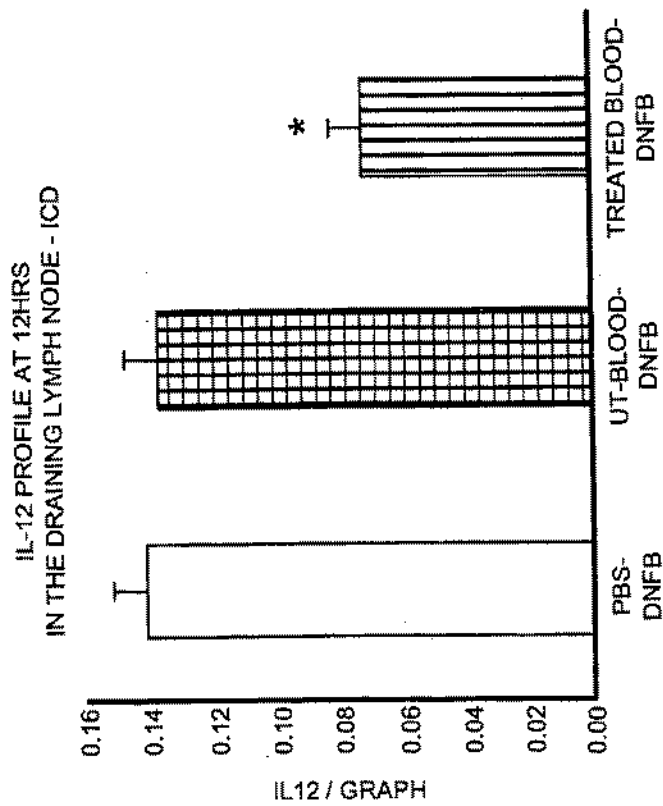
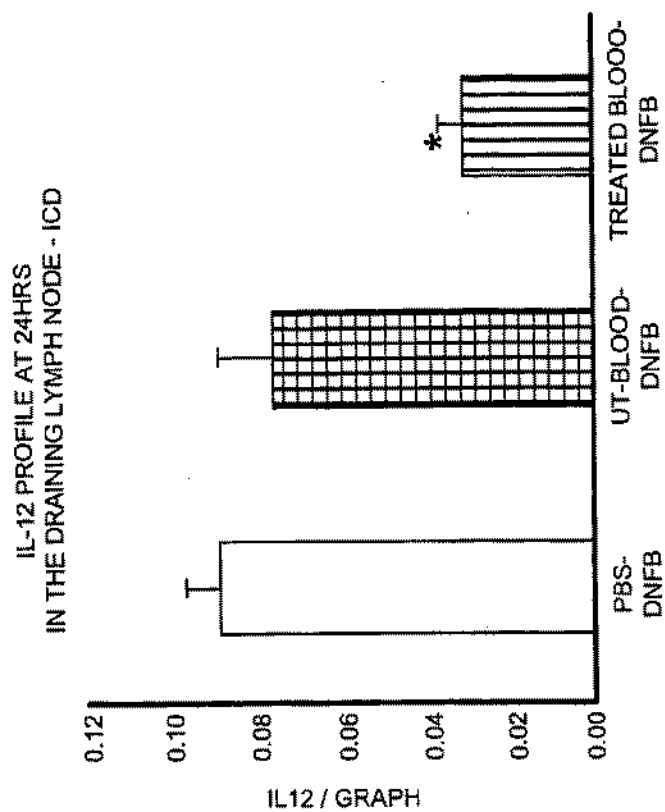


FIG. 2



**FIG. 3**

## ACUTE INFLAMMATORY CONDITION TREATMENT

### FIELD OF THE INVENTION

[0001] This invention relates to processes, medical treatments, and compositions for alleviating acute inflammatory conditions in mammalian patients.

### BACKGROUND OF THE INVENTION

[0002] "Acute inflammatory conditions" as the term is used herein, and in accordance with normal medical parlance, refers to inflammatory conditions having a rapid onset and severe symptoms. The duration of the onset, from a normal condition of the patient to one in which symptoms of inflammation are seriously manifested, is anything up to about 72 hours. Acute inflammatory conditions are to be contrasted with chronic inflammatory conditions, which are inflammatory conditions of long duration, denoting a disease showing little change or of slow progression. The distinction between acute and chronic conditions is well known to those in the medical professions, even if they are not distinguishable by rigid, numbers-based definitions.

[0003] It is known that many inflammatory conditions are associated with an abnormal secretion level of various cytokines in the mammalian body. Professional antigen-presenting cells (APCs), including dendritic cells and macrophages, actively capture and process antigens, clear cell debris, and remove infectious organisms and dying cells, including the residues from dying cells. During this process, APCs can stimulate the production of either inflammatory Th1 pro-inflammatory cytokines (IL-12, IL-1, TNF- $\alpha$ , IFN- $\gamma$ , etc); or regulatory, Th2/Th3 anti-inflammatory cytokines (IL-10, IL-4, TGF- $\beta$  etc) dominated responses, depending on the nature of the antigen or phagocytosed material and the level of APC maturation/activation.

[0004] The present invention addresses acute inflammatory disorder by a process involving subsection of blood to oxidizing environments such as ozone.

### BRIEF REFERENCE TO THE PRIOR ART

[0005] U.S. Pat. No. 3,715,430 Ryan relates to a method and apparatus for producing substantially pure oxygen having a controlled content of ozone and higher oxygen polymers. The purified oxygen gas is exposed to ultraviolet light in a wavelength of 2485 to 2537 angstrom units in order to produce 5 to 500 parts per million of ozone and higher oxygen polymers in the gas mixture. Ryan indicates that the gas produced in this manner is non-irritating to the human body and may be intravenously injected into the blood stream for therapeutic use.

[0006] U.S. Pat. No. 4,632,980 Zee et al. discloses a method of freeing blood and blood components of enveloped viruses by contacting the blood or blood product in an aqueous medium with an enveloped virus inactivating amount of ozone. The treatment is carried out at a temperature of 4° to 37° Celsius, and an ozone concentration of 1-100 ppm.

[0007] U.S. Pat. No. 4,831,268 Fisch et al. provides a method for the radiation of blood to prevent arteriosclerosis related heart and vascular diseases caused by disturbances in the fat exchange. The disclosed process involves irradiating the blood in a blood conducting tube with radiation having an intensity of from about 1 mW/cm<sup>2</sup> to 10 mW/cm<sup>2</sup> in a wavelength of from about 300 to 600 nm.

[0008] U.S. Pat. No. 4,968,483 Mueller et al. describes an apparatus for oxygenating blood, by treating an aliquot of a patient's blood extracorporeally, with an oxygen/ozone mixture and ultraviolet light, at a controlled temperature. The apparatus is proposed for use in haematological oxidation therapy.

[0009] U.S. Pat. No. 6,204,058 Bolton discloses a process for preparing an autovaccine for administration to an autoimmune disease-suffering mammalian patient to alleviate the patient's autoimmune disease symptoms, by treating an extracted blood aliquot extracorporeally by subjecting it to an immune system-modifying amount of ozone gas and ultraviolet radiation, where the treated blood aliquot has at least one specified feature such as increased numbers of leucocytes exhibiting a condensed apoptotic-like morphology.

### SUMMARY OF THE INVENTION

[0010] The present invention is based upon the discovery that blood treated with various stressors such as ozone, will, upon administration to a mammalian patient, cause a rapid decrease in the level of inflammatory cytokines such as TNF- $\alpha$ , IFN- $\gamma$  and IL-12, the effects being significant within the first twelve hours after the administration of the treated blood. Accordingly, the treated blood may be used to treat acute inflammatory diseases and/or to delay and/or to ameliorate symptoms associated with such diseases.

[0011] In one aspect, the present invention provides a method of alleviating acute inflammatory conditions in a mammalian subject, comprising: (a) extracting an aliquot of blood from the subject; (b) treating the aliquot of blood *ex vivo* with at least two stressors selected from the group consisting of an oxidizing agent, an electromagnetic emission and elevated temperature; and (c) administering the aliquot of blood treated in step (b) to the subject.

[0012] A further aspect of the invention is the use in the preparation of a medicament for treating acute inflammatory conditions in a mammalian patient, of autologous blood which has been stressed *ex vivo* by subsection to at least two stressors selected from an oxidizing agent, electromagnetic emission, and elevated temperature.

[0013] The preparation of the treated blood for use in the present invention preferably comprises extracting from the subject an aliquot of blood of volume about 0.01 ml to about 400 ml, and contacting the aliquot of blood, extracorporeally, with an immune system-stimulating effective amount of ozone gas and an electromagnetic transmission.

[0014] The method for alleviating acute inflammatory conditions in a human subject, in accordance with a preferred embodiment of the present invention, comprises extracting from the patient an aliquot of blood of volume about 0.01 ml to about 400 ml, contacting the aliquot of blood, extracorporeally, with an immune system-stimulating amount of ozone gas and an electromagnetic emission, followed by administering the treated blood aliquot to the subject.

[0015] Following administration to the mammalian patient, the treated blood is believed to interact rapidly with the immune system resulting in the rapid development of an anti-inflammatory response, as evidenced by changes in cytokine profile.

### BRIEF DESCRIPTION OF THE DRAWINGS

[0016] FIG. 1 is a set bar graphs comparing the cytokine IL-1 $\beta$  mRNA expression (12 hour vs. 24 hour) from the

draining lymph node of mice treated in the ICD model (as later described), Example 1 herein;

[0017] FIG. 2 is a similar graph for the cytokine IFN- $\gamma$ , Example 1 herein;

[0018] FIG. 3 is a similar graph for the cytokine IL-12, Example 1 herein

#### DESCRIPTION OF PREFERRED EMBODIMENTS

[0019] According to the present invention, blood from patients suffering from acute inflammatory conditions is treated, extracorporeally, with various stressors such as an electromagnetic emission or ozone (including combinations of stressors).

[0020] Exactly how the treatment operates following this re-injection is not currently fully understood. The following tentative explanation is offered for a better and more complete description of the invention, but is not to be considered as binding or limiting.

[0021] T-cells, which are one kind of lymphocyte and which play a significant role in the control of the immune system, include CD-8 cells, and CD-4 cells otherwise known as T-helper cells, further subdividable into Th1 and Th2 cells. The Th1 cells secrete pro-inflammatory cytokines such as interferon gamma (IFN- $\gamma$ ). The Th2 cells are considered to be regulatory cells and secrete regulatory cytokines, such as interleukin-4 (IL-4). A number of components of the treated blood of the present invention, possibly including HLA-DR and/or other MHC antigens released from the leucocyte cell surfaces, upregulate the Th2 cells in the patient's blood and/or locally at the site of the inflammation, thereby increasing the secretion of regulatory cytokines or having other effects.

[0022] A patient or a subject is identified as having a need for prophylaxis or treatment of an acute inflammatory disorder. A blood aliquot from the patient is prepared by exposing the aliquot to at least two stressors, in controlled amounts, the stressor being selected from among oxidizing agents such as ozone, ultraviolet radiation and elevated temperature. Combinations of all three of such stressors are preferred. The resulting blood aliquot, after such treatment, can be reinjected into the patient.

[0023] Preferably, the stressors to which the cells in the extracted blood aliquot are subjected are a temperature stress (blood temperature above body temperature), an oxidative environment such as a mixture of ozone and oxygen bubbled through the blood aliquot, and an electromagnetic emission, individually, in any combination, simultaneously or successively, but preferably simultaneously.

[0024] In general, from about 0.01 ml to about 400 ml of blood may be treated according to the invention. Preferred amounts are in the range of about 0.1 to about 200 ml. More suitably, the aliquot for treatment has a volume of from about 0.1 to about 100 mls, preferably 1 to about 50 ml and most preferably 5 to 15 ml. The method most preferably involves treating an aliquot of about 10 mls blood with ozone gas and an electromagnetic emission, then re-administering the treated blood to the patient by intramuscular injection.

[0025] It is preferred, according to the invention, to apply a temperature stress (blood temperature above or below body temperature), in addition to the electromagnetic emission stress and the oxidative stress. Preferably, all three of the aforementioned stressors are applied simultaneously to the aliquot under treatment, in order to ensure the appropriate modification to the blood. Care must be taken to utilize an

appropriate level of the stressors to thereby effectively modify the blood to alleviate the acute inflammatory condition in the subject.

[0026] The temperature stressor warms the aliquot being treated to a temperature above normal body temperature or cools the aliquot below normal body temperature. The temperature is selected so that the temperature stressor does not cause excessive hemolysis in the blood contained in the aliquot and so that, when the treated aliquot is injected into a subject, alleviation of the acute inflammatory condition will be achieved. Preferably, the temperature stressor is applied so that the temperature of all or a part of the aliquot is up to about 55° C., and more preferably in the range of from about -5° C. to about 55° C.

[0027] In some preferred embodiments of the invention, the temperature of the aliquot is raised above normal body temperature, such that the mean temperature of the aliquot does not exceed a temperature of about 55° C., more preferably from about 40° C. to about 50° C., even more preferably from about 40° C. to about 44° C., and most preferably about 42.5±1° C.

[0028] In other preferred embodiments, the aliquot is cooled below normal body temperature such that the mean temperature of the aliquot is within the range of from about -5° C. to about 36.5° C., even more preferably from about 10° C. to about 30° C., and even more preferably from about 15° C. to about 25° C.

[0029] Alternatively, the blood sample is heated while being subjected to an electromagnetic emission until the blood reaches a predetermined temperature (preferably about 42.5±1° Celsius) at which point bubbling of ozone gas through the blood is commenced. The concurrent electromagnetic emission/ozone treatment is then maintained for a predetermined period of time, preferably about 3 minutes.

[0030] Another alternative method involves subjecting the blood to electromagnetic emission/ozone while heating to a predetermined temperature (preferably about 42.5±1° Celsius), then either ending the treatment once the predetermined temperature is reached, or continuing electromagnetic emission/ozone treatment for a further period of time, most preferably about 3 minutes.

[0031] The oxidative environment stressor can be the application to the aliquot of solid, liquid or gaseous oxidizing agents. Chemical oxidants such as hydrogen peroxide can be used. Preferably, it involves exposing the aliquot to ozone gas. More preferably, it involves exposing the aliquot to a mixture of medical grade oxygen and ozone gas, most preferably by bubbling through the aliquot, at the aforementioned temperature range, a stream of medical grade oxygen gas having ozone as a minor component therein. The ozone content of the gas stream and the flow rate of the gas stream should be selected such that the amount of ozone introduced to the blood aliquot, either on its own or in combination with other stressors, does not give rise to excessive levels of cell damage such that the therapy is rendered ineffective. Suitably, the gas stream has an ozone content of up to about 300  $\mu\text{g/ml}$ , preferably up to about 100  $\mu\text{g/ml}$ , more preferably about 30  $\mu\text{g/ml}$ , even more preferably up to about 20  $\mu\text{g/ml}$ , particularly preferably from about 10  $\mu\text{g/ml}$  to about 20  $\mu\text{g/ml}$ , and most preferably about 14.5±1.0  $\mu\text{g/ml}$ . The gas stream is suitably supplied to the aliquot at a rate of up to about 2.0 litres/min, preferably up to about 0.5 litres/min, more preferably up to about 0.4 litres/min, even more preferably up to about 0.33 litres/min, and most preferably about 0.24±0.024

litres/min. The lower limit of the flow rate of the gas stream is preferably not lower than 0.01 litres/min, more preferably not lower than 0.1 litres/min, and even more preferably not lower than 0.2 litres/min.

**[0032]** The electromagnetic emission stressor is suitably applied by irradiating the aliquot under treatment from a source of an electromagnetic emission while the aliquot is maintained at the aforementioned temperature and while the oxygen/ozone gaseous mixture is being bubbled through the aliquot. Preferred electromagnetic emissions are selected from photonic radiation, more preferably UV, visible and infrared light, and even more preferably UV light. The most preferred UV sources are UV lamps emitting primarily UV-C band wavelengths, i.e. at wavelengths shorter than about 280 nm. Such lamps may also emit amounts of visible and infrared light. Ultraviolet light corresponding to standard UV-A (wavelengths from about 315 to about 400 nm) and UV-B (wavelengths from about 280 to about 315) sources can also be used. For example, an appropriate dosage of such UV light, applied simultaneously with the aforementioned temperature and oxidative environment stressors, can be obtained from lamps with a combined power output of from about 45-65 mW/cm<sup>2</sup>. Up to eight such lamps surrounding the sample container holding the aliquot, with a combined output at 253.7 nm of 15-25 watts, operated at an intensity to deliver a total UV light energy at the surface of the blood of from about 0.025 to about 10 joules/cm<sup>2</sup>, preferably from about 0.1 to about 3.0 joules/cm<sup>2</sup>. Preferably, four such lamps are used.

**[0033]** The time for which the aliquot is subjected to the stressors can be from a few seconds to about 60 minutes. The time depends to some extent upon the chosen intensity of the electromagnetic emission, the temperature and the concentration of the rate at which the oxidizing agent is supplied to the aliquot. Some experimentation to establish optimum times may be necessary on the part of the operator, once the other stressor levels have been set. Under most stressor conditions, preferred times will be in the approximate range of from about 2 to about 5 minutes, more preferably around 3 minutes. The starting blood temperature and the rate at which it can be warmed or cooled to a predetermined temperature, tends to vary from subject to subject.

**[0034]** Warming is suitably by use of one or more infrared lamps placed adjacent to the aliquot container. Other methods of warming can also be adopted.

**[0035]** In the practice of the preferred process of the present invention, the blood aliquot (or the separated cellular fractions of the blood, or mixtures of the separated cells, including platelets, these various leucocyte-combinations, along with whole blood, being referred to collectively throughout as the "aliquot") may be treated with the stressors using an apparatus of the type described in U.S. Pat. No. 4,968,483 Mueller. The aliquot is placed in a suitable, sterile, UV light-transmissive container, which is fitted into the machine. The UV lamps are switched on for a fixed period before the gas flow is applied to the aliquot providing the oxidative stress, to allow the output of the UV lamps to stabilize. The UV lamps are typically on while the temperature of the aliquot is adjusted to the predetermined value, e.g. 42.5±1° C. Then the oxygen/ozone gas mixture, of known composition and controlled flow rate, is applied to the aliquot, for the predetermined duration of up to about 60 minutes, preferably 2 to 5 minutes and most preferably about 3 minutes as discussed above, so that the aliquot experiences all three stressors

simultaneously. In this way, blood is appropriately modified according to the present invention to achieve the desired effects.

**[0036]** Thus, the invention also provides a method of stimulating or activating the immune system in the a human by contacting about 0.01 ml to about 400 ml of blood from a human with an immune system-stimulating amount of ozone gas and ultraviolet radiation, followed by administering the treated blood to a human. It is believed that this stimulation or activation of the immune system may have the effect of treating acute inflammatory conditions or disorders. Similarly, the invention contemplates a method of treating an existing acute inflammatory condition or disorder in a human by contacting about 0.01 ml to about 400 ml of blood from a human with an immune system-stimulating amount of ozone gas and ultraviolet radiation, followed by administering the treated blood to a human.

**[0037]** A subject preferably undergoes a course of treatments, each individual treatment comprising removal of a blood aliquot, treatment thereof as described above and re-administration of the treated aliquot to the subject. A course of such treatments may comprise daily administration of treated blood aliquots for a number of consecutive days, or may comprise a first course of daily treatments for a designated period of time, followed by an interval and then one or more additional courses of daily treatments.

**[0038]** In one preferred embodiment, the subject is given an initial course of treatments comprising the administration of 1 to 6, more preferably 4 to 6 aliquots of treated blood. In another preferred embodiment, the subject is given an initial course of therapy comprising administration of from 2 to 4 aliquots of treated blood, with the administration of any pair of consecutive aliquots being either on consecutive days, or being separated by a rest period of from 1 to 21 days on which no aliquots are administered to the patient, the rest period separating one selected pair of consecutive aliquots being from about 3 to 15 days. In a more specific, preferred embodiment, the dosage regimen of the initial course of treatments comprises a total of three aliquots, with the first and second aliquots being administered on consecutive days and a rest period of 11 days being provided between the administration of the second and third aliquots. For optimum effectiveness of the treatment, it is preferred that no more than one aliquot of modified blood be administered to the subject per day, in one or more injection sites, and that the maximum rest period between any two consecutive aliquots during the course of treatment be no greater than about 21 days.

**[0039]** It may be preferred to subsequently administer additional courses of treatments following the initial course of treatments. Preferably, subsequent courses of treatments are administered following a rest period of several weeks or months, preferably at least about three weeks, after the end of the initial course of treatments. In one particularly preferred embodiment, the subject receives a second course of treatments comprising the administration of one aliquot of treated blood every 30 days following the end of the initial course of treatments, for a period of 6 months. It may also be preferred in some circumstances to follow one or more of the above-described courses of treatment by periodic "booster" treatments, if necessary, to maintain the desired effects of the present invention. For example, it may be preferred to administer booster treatments at intervals of 3 to 4 months following the initial course of treatment.

**[0040]** It will be appreciated that the spacing between successive courses of treatments should be such that the positive effects of the treatment of the invention are maintained, and may be determined on the basis of the observed response of individual subjects.

**[0041]** The present invention is a process for the treatment of or prophylaxis against acute inflammatory mammalian disorders where inappropriate cytokine expression is involved. Those disorders are generally characterized by acute inflammation that is mediated by cytokines IL-1 $\beta$ , IFN- $\gamma$  and/or cytokines secreted from inflammatory cells e.g. Th-1 cells. A patient having such a disorder may be selected for treatment. "Treatment" includes, for example, a reduction in the number of symptoms, a decrease in the severity of at least one symptom of the particular disease or a delay in the further progression of at least one symptom of the particular disease.

**[0042]** One example of an acute inflammatory disorder that the process of the present invention may treat or help guard against, is acute allergic or toxic reaction from surface contact with environmental and occupational allergens or drugs through anaphylactic shock. More specific examples of such disorders include allergic contact dermatitis, acute hypersensitivity and respiratory allergy.

**[0043]** A second example of an acute inflammatory disorder that the process of the present invention may treat or help guard against, is acute neurological inflammatory injury such as that caused by acute infection.

**[0044]** A third example of an acute inflammatory disorder that the process of the present invention may treat or help guard against, is acute myocardial infarction.

**[0045]** Another example is prophylaxis against or treatment of acute neuronal injury resulting from cardiopulmonary bypass surgery.

**[0046]** A further example is prophylaxis or treatment of acute inflammatory conditions arising from surgical or medical procedures, and medically induced ("iatrogenic") acute inflammatory conditions.

**[0047]** The invention may also be useful in pre-conditioning individuals about to enter an environment in which they will encounter conditions likely to lead to acute inflammatory disorder development, such as harmful chemical-containing environments and insect infested areas.

**[0048]** The prophylaxis or treatment methods described herein may be administered in combination with one or more other modalities. Examples of other preferred modalities include, but are not limited to, non-steroidal and steroidal anti-inflammatories. Administration in combination includes, for example, administration of the treated blood described herein, prior to, during or after administration of the other one or more modalities. One of skill in the art will be able to determine the administration schedule and dosage.

#### EXAMPLE 1

**[0049]** Irritable contact dermatitis (ICD), or acute dermatitis, is an example of acute inflammation, in a model of which an irritant (2,4-dinitrofluorobenzene (DNFB)) is painted on the shaved skin of a mouse and then after certain time points, the draining lymph nodes are collected and analyzed for the mRNA expression of pro- and anti-inflammatory cytokines. This constitutes an accepted animal model of acute inflammatory disorder.

**[0050]** Balb/C mice between 6 to 8 weeks of age were assigned to two time groups, 12 hours and 24 hours. The mice

were further assigned to one of 4 groups in the 24 hour group, A-D, with 5 animals in each group. Group A received no blood and no DNFB. Group B received a 50 microlitre injection of PBS and DNFB irritant treatment, but no treated blood. Group C was treated with DNFB and received an injection of 50 microlitres of untreated whole blood. Group D was treated with DNFB and received an injection of 50 microlitres of treated whole blood. The mice in the 12 hour group were assigned to one of three groups (of 5 mice per group) A-C. Group A received a 50 microlitre injection of PBS and DNFB irritant treatment, but no treated blood. Group B was treated with DNFB and received an injection of 50 microlitres of untreated whole blood. Group C was treated with DNFB and received an injection of 50 microlitres of treated whole blood. Since the negative control group A in the 24 hour group would be expected to have the same results relating to cytokine levels as the 12 hour group, only a 24 hour control group was used.

**[0051]** Whole blood was obtained from Balb/C mice, by extraction from a main artery through an injection needle, and treated with an anti-coagulant. An aliquot of this was subjected to the process of a preferred embodiment of the invention. The remainder was left untreated, for use in control experiments. Since these mice are genetically identical, there is not expected to be an immune response against the injected blood by the recipient mice.

**[0052]** To obtain treated blood, the selected aliquot, in a sterile, UV-transmissive container, was treated simultaneously with a gaseous oxygen/ozone mixture and ultraviolet light at elevated temperature using an apparatus as generally described in aforementioned U.S. Pat. No. 4,968,483 Mueller et al. Specifically, 10 ml of citrated blood was transferred to a sterile low density polyethylene vessel (more specifically, a Vasogen VC7002 Blood Container) for ex vivo treatment with stressors according to the invention. Using an apparatus described in the aforementioned Mueller patent (more specifically, a Vasogen VC7001 apparatus), the blood was heated to 42.5 $\pm$ 1 $^{\circ}$  C. and at that temperature irradiated with UV light principally at a wavelength of 253.7 nm, while oxygen/ozone gas was bubbled through the blood to provide the oxidative environment and to facilitate exposure of the blood to UV. The constitution of the gas mixture was 14.5 $\pm$ 1.0  $\mu$ g/ml, with the remainder of the mixture comprising medical grade oxygen. The gas mixture was bubbled through the aliquot at a rate of 240+24 ml/min for a period of 3 minutes.

**[0053]** Immediately prior to the injections, animals were anaesthetized with 0.2 ml of 5 mg/ml sodium pentobarbital via IP injection. The abdominal skin of the mouse was sprayed with 70% EtOH and a scalpel blade was used to remove about a one-inch diameter patch of hair from the abdomen. Where the mice were treated with DNFB, the shaved area was then painted with 25  $\mu$ l of 0.5% DNFB in 4:1 acetone:olive oil using a pipette tip. All mice were anesthetized and had the belly area shaved. The PBS or blood (treated or untreated) was administered by injection into the lateral gastrocnemius muscle (right leg).

**[0054]** All animals in the two time groups were sacrificed after the respective time points. From each sacrificed animal, the draining lymph nodes were harvested. The RNA was extracted from the lymph nodes, and subjected to RT-PCR analysis for expression of the pro-inflammatory cytokines IL-1- $\beta$ , IFN- $\gamma$  and IL-12. The results were determined in comparison with the standard reporter gene GAPDH, which is known to be expressed at 100% levels.

**[0055]** The data, as cytokine/GAPDH for the various cytokines at 12 and 24 hours, are presented graphically on FIGS. 1-3.

**[0056]** FIG. 1 pertains to IL-1 $\beta$  measurements. These are plotted, as a ratio to housekeeping gene GAPDH, as vertical axis, comparing the results for various experimental conditions at 12 hours and 24 hours. Each point represents the mean of five measurements with the error bars representing the standard error of the mean. The data at 12 hours shows the pro-inflammatory cytokine IL-1 $\beta$  is significantly downregulated, in comparison to the PBS-DNFB ( $p=0.022$ ) and untreated blood-DNFB ( $p=0.001$ ), when treated blood was injected into the mice, as determined by ANOVA. The results at 24 hours were also significant when comparing mice having the treated blood treatment in comparison to PBS-DNFB ( $p<0.001$ ) and untreated blood-DNFB ( $p<0.001$ ). This is an indication of the potential of the process of the present invention to combat acute IL-1 $\beta$  related disorders in mammalian patients, such as early pulmonary inflammation resulting from hepatic injury, unstable angina, acute juvenile and rheumatoid arthritis, and acute ischemia.

**[0057]** FIG. 2 similarly presents the results of measurements of IFN- $\gamma$ , another pro-inflammatory cytokine. Here the effect of the treated blood is noticeable and significant at both 12 ( $p<0.05$ ) and 24 hours ( $p<0.001$ ) in comparison to untreated blood-DNFB or PBS-DNFB at 24 hours ( $p=0.011$ ) as determined by ANOVA, further indication of the potential of this invention in treating acute inflammatory disorders, especially those in which IFN- $\gamma$  plays a significant role, such as coronary arterial inflammation, pericarditis and acute coronary syndrome.

**[0058]** FIG. 3 similarly presents the results for measurement of IL-12, an inflammatory cytokine. Again, there is significant downregulation of IL-12 in the treated blood group at 12 hours ( $p=0.003$ ) and 24 hours ( $p=0.003$ ), in comparison to the PBS-DNFB condition, and significant downregulation of IL-12 at 12 hours ( $p=0.01$ ) and 24 hours ( $p=0.01$ ) in the untreated blood-DNFB condition as determined by ANOVA. This is indicative of the potential of the preferred embodiments of the invention in combating IL-12 related acute inflammatory disorders such as acute respiratory syndrome, acute inflammatory response due to organ transplant and acute inflammatory bowel disease.

#### EXAMPLE 2

**[0059]** Blood (10 ml) from syngeneic male F1 Lewis Brown Norway (LBN) rats was pooled, and subjected to exposure to heat, UVC light and ozone/oxygen gaseous mixture using a VC7001 device (Vasogen Inc.). The conditions of blood treatment were as described in Example 1, namely 10 ml of blood treated with sodium citrate anticoagulant was heated to a temperature of  $42.5\pm 1^\circ\text{C}$ ., and at that temperature the blood was irradiated with UV light principally at a wavelength of 253.7 nm, while ozone/oxygen gas mixture (14.5 $\pm$ 1.0  $\mu\text{g/ml}$  ozone, balance medical grade oxygen) was bubbled through the blood aliquot at a rate of 240 $\pm$ 24 ml/minute for a period of 3 minutes.

**[0060]** Twenty LBN male F1 rats were allotted to either a treatment group (12) or a control group (8). On day 1, day 2 and day 14, rats in the treatment group were injected in the gluteus muscle with 150  $\mu\text{l}$  of the treated blood. Rats in the control group were similarly injected, on the same schedule, with 150  $\mu\text{l}$  of saline.

**[0061]** On day 15, the animals were surgically operated on, subjecting them to coronary artery ligation. The animals were then studied by echo cardiography through the acute phase following the surgery, to monitor the cardiac function of the animals following the ligation.

**[0062]** The echo cardiography revealed a significant reduction in left ventricular end-diastolic area in rats of the treatment group during the acute phase, as compared with rats of the control group. This is indicative of a protective effect and early benefit on cardiac remodeling after coronary artery ligation. These results are supportive of the potential utility of the process and procedures of the present invention in treatment of acute inflammatory conditions such as acute myocardial infarction and acute inflammatory conditions arising from surgical procedures.

1-17. (canceled)

**18.** A method for prophylaxis or treatment of an acute inflammatory disorder, wherein the acute inflammatory disorder is characterized by a rapid onset and severe symptoms where the duration of the onset from a normal condition to one in which symptoms of inflammation are seriously manifested is up to about 72 hours, and wherein the acute inflammatory disorder involves inappropriate cytokine expression by inflammatory cells, said method comprising administering an aliquot of blood to a mammalian patient in need thereof, wherein the aliquot has been treated ex vivo with at least two stressors selected from the group consisting of an oxidizing agent, an electromagnetic emission and an elevated temperature.

**19.** The method of claim 18, wherein the oxidizing agent comprises ozone gas.

**20.** The method of claim 19, wherein the oxidizing agent comprises a mixture of medical grade oxygen and ozone gas.

**21.** The method of claim 20, wherein the ozone is administered as a gas stream in admixture with medical grade oxygen at a rate of from 0.01-2.0 liters per minute.

**22.** The method of claim 18, wherein the electromagnetic emission is ultraviolet radiation.

**23.** The method of claim 22, wherein the ultraviolet radiation is supplied from at least one ultraviolet lamp emitting in the C-band wavelength.

**24.** The method of claim 18, wherein the elevated temperature is  $42.5\pm 1^\circ\text{C}$ elsius.

**25.** The method of claim 18, wherein three stressors are applied to the blood simultaneously, wherein the three stressors are ozone gas, ultraviolet radiation and a temperature of from  $40^\circ$  to  $50^\circ\text{C}$ elsius.

**26.** The method of claim 25, wherein the ozone is administered as a gas stream in admixture with medical grade oxygen at a rate of from 0.01-2.0 liters per minute.

**27.** The method of claim 26, wherein the blood aliquot is treated with ozone and ultraviolet radiation at a temperature from  $40^\circ$  to  $44^\circ\text{C}$ elsius for a period of from 2 to 5 minutes, the ozone/oxygen mixture being supplied at a rate of from 0.1-1.0 liters per minute, with an ozone content of from 10-300  $\mu\text{g/ml}$ .

**28.** The method of claim 25, wherein the temperature is  $42.5\pm 1^\circ\text{C}$ elsius.

**29.** The method of claim 18, wherein the aliquot administered to the mammalian patient is from 0.01 to 400 ml.

**30.** The method of claim 29, wherein the aliquot administered to the mammalian patient is from 1 to 50 ml.



31. The method of claim 18, wherein the acute inflammatory disorder is acute allergic or toxic reaction from surface contact with environmental allergen or drugs through anaphylactic shock.

32. The method of claim 18, wherein the acute inflammatory disorder is allergic contact dermatitis or acute hypersensitivity.

33. The method of claim 18, wherein the acute inflammatory disorder is acute neurological inflammatory injury.

34. The method of claim 18, wherein the acute inflammatory disorder is acute neuronal injury resulting from cardiopulmonary bypass surgery.

35. The method of claim 18, wherein the acute inflammatory disorder arises from surgical or medical procedures.

36. The method of claim 18, wherein the acute inflammatory disorder arises from medically induced acute inflammatory conditions.

\* \* \* \* \*

# Celacade studies

<http://www.ncbi.nlm.nih.gov/pubmed/9498159>

J Biol Regul Homeost Agents. 1997 Jul-Sep;11(3):104-10.

## **Effect of combined heat, ozonation and ultraviolet irradiation (VasoCare) on heat shock protein expression by peripheral blood leukocyte populations.**

Bulmer J<sup>1</sup>, Bolton AE, Pockley AG.

Author information

### **Abstract**

The re-administration of whole blood subjected to heat, ozonation and ultraviolet irradiation (VasoCare therapy) has been shown to elicit clinical benefits in individuals with vascular disease. Given that these stressors induce heat shock protein (Hsp) expression and that heat shock protein reactivity is implicated in the pathogenesis of vascular disease, this study assessed the effect of VasoCare on intracellular expression of Hsp60 and Hsp70 by treated peripheral blood leukocytes. Contrary to expectations, VasoCare induced a significant reduction (approximately 40%) in the proportion of peripheral blood mononuclear cells expressing intracellular Hsp60 and Hsp70, whereas it had no effect on heat shock protein expression by peripheral blood neutrophils. Cell surface heat shock protein expression was not detectable. The reduced expression of Hsp60 by mononuclear cells was concomitant with an increase in the levels of Hsp60 in treated plasma. Although the mechanism underlying the clinical effectiveness of VasoCare therapy has yet to be established, it may be that re-administration of treated blood or soluble factors derived therefrom modifies in vivo immune responsiveness to heat shock proteins or associated molecules.

<http://www.ncbi.nlm.nih.gov/pubmed/9543222>

Int Angiol. 1997 Dec;16(4):250-4.

## **Treatment of severe Raynaud's syndrome by injection of autologous blood pretreated by heating, ozonation and exposure to ultraviolet light (H-O-U) therapy.**

Cooke ED<sup>1</sup>, Pockley AG, Tucker AT, Kirby JD, Bolton AE.

Author information

### **Abstract**

#### **OBJECTIVE:**

To determine the effect of re-injection of small samples of autologous blood, pretreated with heat, ozone and ultraviolet light (H-O-U therapy) in patients with severe Raynaud's syndrome.

#### **EXPERIMENTAL DESIGN:**

Open trial in 4 patients.

#### **SETTING:**

Temperature/humidity controlled vascular laboratory.

**PATIENTS:**

Severe Raynaud's syndrome of more than 5 years duration and defined as more than 5 attacks daily or 10 attacks in one week, at least half of which were painful and lasting for more than 30 minutes. Three patients were refractory to infusions of Iloprost.

**INTERVENTIONS:**

Patients were treated daily or on alternate days for a two to three weeks period by re-injection of citrated autologous blood pre-treated with heat, ozone and ultraviolet light (H-O-U therapy).

**MEASURES:**

Clinical observations; mean equilibrated hand temperature (infrared thermography); distributive and microcirculatory blood-flow (venous occlusion strain-gauge plethysmography, infrared photoplethysmography, laser Doppler flowmetry) iontophoresis of acetylcholine and sodium nitroprusside; estimations: serum levels of 6-keto-PGF1alpha and serum levels of anti-hsp65 antibody.

**RESULTS:**

Reduction or abolition of Raynaud's attacks for at least three months after treatment. Mean equilibrated hand temperature increased but did not normalise. Blood flow parameters improved but did not reach statistical significance. Iontophoresis of acetylcholine showed an increase in laser Doppler flowmetry which was statistically significant. Serum levels of 6-keto-PGF1alpha, fell significantly in three patients. Serum levels of anti-hsp65 antibody fell in the one patient which was followed sequentially.

**CONCLUSIONS:**

H-O-U therapy may prove useful in patients with severe Raynaud's syndrome.

[Atherosclerosis](#). 2002 May;162(1):45-53.

## **Effects of VasoCare therapy on the initiation and progression of atherosclerosis.**

[Babaei S<sup>1</sup>](#), [Stewart DJ](#), [Picard P](#), [Monge JC](#).

**Author information**

**Abstract**

VasoCare therapy, which involves the administration of autologous blood following the ex vivo exposure to physico-chemical stressors, has been shown to modulate immune responses. Since immune mechanisms have been recognized to be pivotal in the pathogenesis of atherosclerosis, we hypothesized that VasoCare treatment would inhibit atherosclerosis in LDL-R (-/-) mice. Three groups of LDL-R (-/-) mice were studied: a control group that was fed normal chow (Group I) and no other treatment; a control group that received a high cholesterol (HC) diet for 8 weeks (group II) with sham saline injections; and a third group (III) that received HC diet for 8 weeks and VasoCare treatment initiated after four weeks of HC feeding.

Atherosclerotic area (AA), relative to total aortic area (TA), was assessed after 8 weeks of HC feeding by oil red O staining, and cross sectional plaque area at the level of the aortic valve leaflets was determined by quantitative morphometry. HC mice exhibited substantial aortic lipid deposition which was profoundly

reduced in the VasoCare treated animals (AA/TA ratios in group II: 0.32±/0.15 vs. group III: 0.17±/0.06; P<0.05).

This was associated with a significant decrease in cross sectional area of plaque in the aortic sinuses. VasoCare therapy also reduced the xanthoma formation and limb swelling characteristic of this animal model. However, cholesterol levels, measured by an enzymatic assay, showed similar marked increases in total serum cholesterol (CHO) in the animals receiving HC diet alone and those receiving the HC diet and VasoCare treatment [group I: 5.4±/0.8 mM, group II: 46.7±/3.6 mM, and group III: 44.7±/2.8 mM (P<0.01 vs. group I)]. We conclude that VasoCare treatment inhibits progression of atherosclerotic lesions in a murine model of human familial hypercholesterolemia by a mechanism independent of cholesterol lowering.

<http://www.ncbi.nlm.nih.gov/pubmed/12451244>

Transplantation. 2002 Nov 27;74(10):1425-33.

## **Renal ischemia-reperfusion injury in the rat is prevented by a novel immune modulation therapy.**

Tremblay J<sup>1</sup>, Chen H, Peng J, Kunes J, Vu MD, Der Sarkissian S, deBlois D, Bolton AE, Gaboury L, Marshansky V, Gouadon E, Hamet P.

### **Author information**

#### **Abstract**

#### **BACKGROUND:**

Vasogen Inc.'s (Mississauga, Ontario, Canada) immune modulation therapy (IMT) is a therapy in which cells from the patient's own blood are modified by ex vivo exposure to specific physicochemical stressors, including oxidation, ultraviolet (UV) light, and an elevated temperature. The therapy has been shown to have a beneficial effect in models of inflammation and vascular diseases. This study tested the hypothesis that IMT can prevent renal ischemia-reperfusion (I/R) injury in rats.

#### **METHODS:**

Whole blood was collected from syngeneic age-matched donors by cardiac puncture. It was treated with a combination of controlled physicochemical stressors consisting of elevated temperature, a gas mixture of medical oxygen containing ozone, and UV light. The treated blood (150 microL) was injected in the gluteal muscle. Control animals received the same volume of untreated blood or physiological saline. Transient (45 or 60 minutes) left-renal ischemia was produced with simultaneous contralateral nephrectomy in treated and control spontaneously hypertensive rats (SHR). Young and old male and female rats were studied. Plasma creatinine, diuresis, and the survival rates of each group were compared. Renal apoptosis-necrosis was estimated by DNA laddering, histology, and in situ terminal deoxynucleotidyl transferase assay. mRNA levels of several regulators of apoptosis-regeneration were determined in control and postischemic kidneys by Northern blotting.

#### **RESULTS:**

IMT pretreatment of SHR significantly reduced renal I/R injury compared with equivalent placebo treatments consisting of untreated blood- or saline-injected SHR, as evidenced by a significant

increase of the survival rate curves in young and old male SHR, which correlated with 24-hour postischemic diuresis. The increases in plasma creatinine following renal I/R were significantly lower in IMT-treated young male and old female SHR compared with saline or untreated blood-injected controls. Dilution analysis showed that the protective effect of treated blood was lost by dilution. Loss of epithelial cells was reduced in IMT-treated rats, with a significant decline in the peak of apoptosis 12 hours after acute ischemic renal injury. IMT did not modify the pattern of mRNA levels of several genes involved in the inflammation and regeneration processes.

#### **CONCLUSION:**

Our data demonstrate that IMT prevents the destruction of kidney tissue and the resulting animal death caused by renal I/R injury

<http://www.ncbi.nlm.nih.gov/pubmed/12207162>

[Neuroimmunomodulation](#). 2002;10(1):40-6.

## **Attenuation of LPS-induced changes in synaptic activity in rat hippocampus by Vasogen's Immune Modulation Therapy.**

[Nolan Y<sup>1</sup>](#), [Minogue A](#), [Vereker E](#), [Bolton AE](#), [Campbell VA](#), [Lynch MA](#).

#### **Author information**

#### **Abstract**

Systemic injection of lipopolysaccharide (LPS) blocks the expression of long-term potentiation in the hippocampus of the rat. This is coupled with increased IL-1beta concentration and c-Jun NH(2)-terminal kinase activity, as well as an increase in the number of cells displaying apoptotic characteristics in the hippocampus. Vasogen's Immune Modulation Therapy (IMT) is a procedure involving intramuscular administration of syngeneic blood which has been exposed ex vivo to elevated temperature, oxidation and ultraviolet light. We report that Vasogen's IMT significantly abrogates these LPS-induced effects with a concomitant increase in the concentration of the anti-inflammatory cytokine IL-10. These data suggest that Vasogen's IMT may play a protective role against the deleterious effects of immune insults in the brain.

Copyright 2002 S. Karger AG, Basel

Journal of the American College of Cardiology Vol. 44, No. 6, 2004

© 2004 by the American College of Cardiology Foundation

## **Effects of a Novel Immune Modulation Therapy in Patients With Advanced Chronic Heart Failure**

### **Results of a Randomized, Controlled, Phase II Trial**

Guillermo Torre-Amione, MD, PhD, FACC,\* François Sestier, MD,† Branislav Radovancevic, MD,‡ James Young, MD§ *Houston, Texas; Montreal, Quebec, Canada; and Cleveland, Ohio*

**OBJECTIVE** We sought to determine whether a novel, non-pharmacological form of immune modulation therapy (IMT), shown experimentally to reduce inflammatory and increase anti-inflammatory cytokines, improved outcomes in patients with advanced heart failure (HF).

**BACKGROUND** Immune activation contributes to the progression of HF, but treatments directed against inflammation have been largely unsuccessful.

**METHODS** Seventy-five HF patients (New York Heart Association [NYHA] functional class III to IV) were randomized to receive either IMT (n = 38) or placebo (n = 37) in a double-blind trial for six months, with continuation of standard HF therapy. Patients were evaluated using the 6-min walk test, changes in NYHA functional class, cardiac function, and quality of life assessments, as well as occurrence of death and hospitalization.

**RESULTS** There was no between-group difference in 6-min walk test, but 15 IMT patients (compared with 9 placebo) improved NYHA functional classification by at least one class (p = 0.140). The Kaplan-Meier survival analysis showed that IMT significantly reduced the risk of death. These preliminary findings are consistent with the hypothesis that immune activation is important in the pathogenesis of HF and establish the basis for a phase III trial to define the benefit of IMT in chronic HF. (p = 0.022) and hospitalization (p = 0.008).

<http://www.ncbi.nlm.nih.gov/pubmed/15925561>

*Am J Cardiol.* 2005 Jun 6;95(11A):24C-29C; discussion 38C-40C.

## **Biologic effects and basic science of a novel immune-modulation therapy.**

Bolton AE.

Author information

### **Abstract**

The immune system is a system of dynamic equilibrium, with inflammatory responses (mediated by T helper type 1 cells, interleukin [IL]-1beta, interferon-gamma, and tumor necrosis factor-alpha [TNF-alpha]) being balanced by anti-inflammatory responses (mediated by T regulatory type 1 cell, T helper type 3 cells, IL-4, IL-10, and transforming growth factor-beta). Therefore, neutralization of inappropriate inflammatory cytokines is a therapeutic strategy that has been attempted in many chronic inflammatory conditions, mostly targeting TNF-alpha, using either monoclonal antibodies or modified receptor proteins (etanercept). There is functional redundancy among the inflammatory cytokines. For example, in addition to TNF-alpha, both IL-1beta and IL-6 are elevated in patients with chronic heart failure (CHF); thus neutralizing the activity of TNF-alpha alone may be an inadequate approach in this patient group. Immune-modulation therapy (IMT) results in downregulation of proinflammatory cytokine levels and upregulation of anti-inflammatory cytokines. This alteration in the balance between proinflammatory and anti-inflammatory cytokines may be more appropriate than neutralizing the activity of a single cytokine in the treatment of conditions such as CHF. Several animal studies investigating the effect of IMT in inflammatory conditions including allergic contact hypersensitivity, ischemia reperfusion injury, and atherogenesis are reviewed.

<http://www.ncbi.nlm.nih.gov/pubmed/15785113>

[Neuroimmunomodulation](#). 2005;12(2):113-6.

## **Evidence of an anti-inflammatory role for Vasogen's immune modulation therapy.**

[Nolan Y<sup>1</sup>](#), [Campbell VA](#), [Bolton AE](#), [Lynch MA](#).

### **Author information**

#### **Abstract**

We have reported that Vasogen's immune modulation therapy (IMT), a procedure involving intramuscular administration of autologous/syngeneic blood, which has been exposed ex vivo to increased temperature, UVC light and oxidation, prevents several LPS-induced inflammatory changes in the hippocampus. Here, we investigated neuroprotective effects of IMT in cortical tissue, and report that the treatment acts as an anti-inflammatory and antioxidative agent, reducing the concentration of TNFalpha and the accumulation of reactive oxygen species. The data couple these changes with an increase in the concentration of the anti-inflammatory cytokine IL-10, and a decrease in activation of the stress-activated protein kinase, c-jun N-terminal kinase. Consistent with these putative protective effects of IMT, we report that the LPS-induced increase in TUNEL staining, which is indicative of cell death, is prevented by IMT.

[Cardiol Rev](#). 2008 Nov-Dec;16(6):280-7. doi: 10.1097/CRD.0b013e318188591c.

## **Device-based nonspecific immunomodulation therapy (Celacade), and its potential role in the treatment of chronic heart failure.**

[Sporter RJ<sup>1</sup>](#), [Kim JH](#), [Frishman WH](#).

### **Author information**

#### **Erratum in**

- [Cardiol Rev](#). 2009 Jan-Feb;17(1):43.

#### **Abstract**

Chronic heart failure (CHF) remains a leading cause of mortality and morbidity, despite the use of optimal standard-of-care medical therapies. Although the role of the immune system in the pathogenesis and progression of CHF has been well-appreciated, attempts to modify specific systemic immune mediators have been unsuccessful. Building on the modest successes of more broad-spectrum immune therapies, Celacade therapy was developed, a device that induces apoptosis in an ex vivo blood sample. Upon reinjection into the body, the treated blood sample has been shown to have an anti-inflammatory effect. Celacade has been successful in several animal models of disease where inflammation plays an important pathogenic role. Two phase III clinical trials of Celacade have been undertaken. A trial on the use of Celacade in peripheral arterial disease with intermittent claudication was terminated early due to a lack of clinical effect, and a larger trial of Celacade treatment in CHF (ACCLAIM) was completed in 2006. ACCLAIM did not reach the primary end point for the overall study population; however, the study results demonstrated a reduced risk of death or first cardiovascular hospitalization by 39% in patients with New York Heart Association class II CHF and a 26% reduction in patients with class II, III, and IV disease who had no prior history of myocardial infarction. Celacade has been approved for treatment of CHF in these groups of

patients in the European Union, and an FDA-mandated confirmatory study of Celacade for possible approval in the United States is in progress.

<http://www.ncbi.nlm.nih.gov/pubmed/19584980>

**Can J Cardiol.** 2009 Jul;25(7):e241-7.

## **Effects of therapy using the Celacade system on structural and functional cardiac remodelling in rats following myocardial infarction.**

[Zhang ML<sup>1</sup>](#), [Mei J](#), [Archer LA](#), [Obayashi M](#), [Diao N](#), [Stuyvers B](#), [ter Keurs HE](#).

### **Author information**

#### **Abstract**

#### **BACKGROUND:**

Immune modulation by the Celacade system (Vasogen Inc, Canada) decreases mortality and hospitalization in human heart failure.

#### **OBJECTIVES:**

To study the effects of Celacade in rats on acute cytokine expression after coronary artery ligation, cardiac dimensions following myocardial infarction (MI), and systolic and diastolic function of cardiac muscle in MI.

#### **METHODS:**

Celacade treatment was administered 14 days before coronary artery ligation and monthly after the surgery. Cytokine expression in cardiac tissue was measured on days 1 and 7 by ELISA in sham rats and in rats with MI (with or without Celacade treatment). Echocardiograms were obtained serially for 16 weeks. Force and sarcomere length (SL) were measured by strain gauge and laser diffraction in isolated right ventricle trabeculas at 16 weeks. The inotropic effect of pacing on force was quantified as F5 Hz/0.5 Hz. Diastolic dysfunction was quantified as the root mean square of spontaneous SL fluctuations.

#### **RESULTS:**

Celacade inhibited transforming growth factor beta-1 production in the infarct area on day 7 (191.6±22.6 pg/mg versus 275.4±30.1 pg/mg; P<0.05), but did not attenuate cardiac dilation in MI. Celacade restored positive inotropism of pacing in MI (F5 Hz/0.5 Hz in Celacade, 219.1±46.7%; MI, 148.1±27.1% [P<0.05 compared with 211.4±37.9% in sham]). Celacade reduced diastolic dysfunction in MI (root mean square of spontaneous SL fluctuations: 121±15% and 143±19% with Celacade versus 184±19% and 190±26% without Celacade at 26 degrees C and 36 degrees C, respectively) compared with sham (100%; P<0.05).

#### **CONCLUSIONS:**

Celacade reduces the increase of transforming growth factor beta-1 expression during the acute stage of MI in rats, but does not prevent chronic cardiac dilation. Celacade restores the positive inotropic effect of increased pacing rate in trabeculas from rat right ventricles with large MIs and reduces diastolic dysfunction.



